

The BEST Plumbing Specialties. One Source.

TABLE OF CONTENTS

A COMMERCIAL

- Bubblers
- Commercial Faucets
- Flush Valve Repair
- Pre Rinse Faucets
- Urinal Parts

B TUBULAR

- Continuous Waste
- P.O. Plugs
- P-Traps
- Strainers

C TOILET REPAIR

- Closet Bolts
- Fill Valves
- Flange Repair
- Flappers
- Flush Valves
- Tank Levers
- Wax Rings

D FAUCET REPAIR

- Cartridges
- Deck Spouts
- Handles
- O-Rings
- Washers

E TUB & SHOWER

- Grab Bars
- Liner
- Shower Drains
- Shower Heads
- Shower Rods
- Tub Spouts

F KITCHEN & LAUNDRY

- Adapter Fittings
- Aerators
- Braided Supplies
- Ducting
- Pantry & Laundry Faucets
- Valves - Quarter Turn & Compression

G PEX & PUSHFIT

- Clamps - PEX
- Fittings - PEX
- Fittings - Pushfit
- Valves - PEX
- Valves - Pushfit

H CHEMICALS

- Antifreeze
- Brushes
- Flux & Cements
- Gel Gloss
- Gloves
- PROSEAL Paste
- Tapes - Other
- Teflon Tape

J SPECIALTIES

- Access Doors
- Ball Valves
- Couplings - Rubber
- Couplings - Transition
- Fire Protection
- Gauges
- Repair Clamps
- Signage
- Test Caps
- Valves - Plumbing
- Wall Plates
- Water Hammer
- Water Heater Parts

K HANGERS & FITTINGS

- Beam Clamps
- Brass & Chrome Fittings
- Cable Ties
- Fittings - Compression
- Hangers
- Nipple Boxes
- SAMMY Screws

L PLUMBERS TOOLS

- Cutters
- Gauges - Test
- Meter Keys
- PEX Tools
- Test Plugs
- Tools - Faucet Repair
- Wrenches - Plumbers

M TRADESMEN'S TOOLS

- Knives
- LENOX Products
- Levels
- MAXPOWER Tools
- Pipe Wrenches
- Saws
- Tie Down Straps
- Tubing

NEW

N
NEW

PULL STOP BOX™
AN ANGLE STOP NEVER LOOKED SO GOOD!



- New innovative angle stop for toilets and faucets
- Looks better and installs more easily than an angle stop or quarter turn valve
- Save 10-15 minutes per install compared to a traditional angle stop
- Saves money
- Installs quickly
- Visually appealing
- Reduces liability
- Easy to use
- Versatile
- For more information visit www.lyncar.com/pullstopbox

Pull Stop Box™ Rough In Kits



- Rough in kit includes temporary cover for protection through construction process

| part # | bulk part # | description |
|-------------|--------------|---|
| 3550 | 3550Q | PULL STOP BOX™ rough in kit 1/2" copper |
| 3551 | 3551Q | PULL STOP BOX™ rough in kit 1/2" PEX |
| 3552 | 3552Q | PULL STOP BOX™ rough in kit 1/2" WIRSBO |

Copyright© 03-2016

NEW

Pull Stop Box™ Trim Kits

part#3553

part#3554



- Trim kit is installed after drywall or tile work is completed
- Deep trim kit is used for installations with cabinets or thick tile

| part # | bulk part # | description |
|-------------|--------------|-------------------------------------|
| 3553 | 3553Q | PULL STOP BOX™ trim kit, white |
| 3554 | 3554Q | PULL STOP BOX™ deep trim kit, white |

Ice Maker Pull Stop Box™

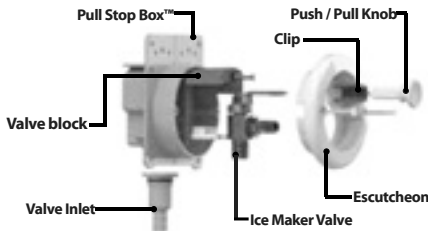

- The sleekest and most sophisticated ice maker box
- Decorative knob controls the water flow
- Attractive cover plate looks great in your kitchen
- Requires a smaller cavity in the wall
- Simple to install



| part # | bulk part # | description |
|-------------|--------------|----------------------|
| 3556 | 3556Q | 1/2" copper rough in |
| 3557 | 3557Q | 1/2" PEX rough in |
| 3558 | 3558Q | 1/2" WIRSBO rough in |
| 3559 | 3559Q | Trim kit |

Pilot Clamp



- The best system for drilling holes up to 2" in diameter into pipe up to 4" in diameter
- Allows quick and easy drilling of a clean hole with no wobble in vertical or horizontal position, even in tight cramped spaces
- Kit includes: Clamp with integrated levels
 - six hole saw guides for fire protection use ranging from 1" to 2"
 - five LENOX hole saws
 - two LENOX arbours
 - pilot bit, chart and case

| part # | description |
|--------------|-----------------|
| 99200 | Pilot clamp kit |

Copyright© 03-2016

NEW

**KORKY PRO Grade™
Max PERFORMANCE
Fill Valve**



- Most universal fill valve - fits KOHLER, TOTO, AMERICAN STANDARD and more
- Height adjusts 1" taller and 1" shorter than other valves
- Adjustable refill port controls allocation of water between tank and bowl - built in settings allow for the optimal adjustment for OEM models
- Specially engineered shank performs as well as brass
- Strengthened gasket designed for high pressure environments, such as high rise
- 7 year warranty - the longest of anyone!
- Sold only through wholesale distribution to professionals

| part # | description |
|-----------------|-------------|
| 10125PRO | Fill Valve |

KORKY Max PERFORMANCE™

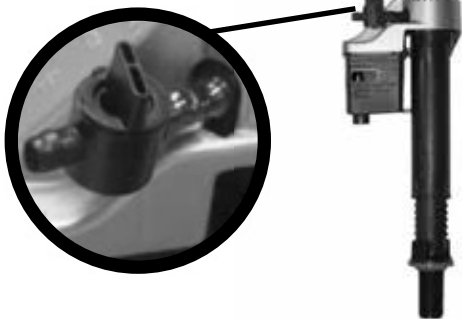

- Universal quiet fill valve made optimized for low flow toilets (up to 1.6 gpf) since 1994
- Adjustment mechanism allows the installer to optimize the allocation of water between the tank and bowl, to maintain OEM performance
- Fits AMERICAN STANDARD CADET 3, KOHLER CIMARRON CLASS FIVE & SIX, KOHLER WELLWORTH, TOTO DRAKE & more
- 5 year guarantee
- Retail packaged

| part # | description |
|----------------|-----------------------|
| 10125MP | KORKY MAX PERFORMANCE |

KORKY Water\$aver®



- Universal quiet watersaver fill valve
- Will not refill during a flapper leak, and automatically shuts down if the flapper is open
- 5 year warranty

| part # | description |
|--------------|-------------------|
| 10153 | KORKY WATER\$AVER |

Soft Jaw Wonder Pliers



- Comes with round and square soft jaw inserts (replacements available)- these will be required with normal use
- Great for repair work on flush valves - will not scratch plated finishes or crush threaded tail pieces.
- Automatically opens by spring loaded mechanism. Opening range of 1" – 2-3/4" and a length of 10-1/2"

| part # | description |
|--------------|---------------------------|
| 4066 | Soft Jaw Plier 10-1/2" |
| 4066R | Replacement round insert |
| 4066S | Replacement square insert |

NOUVEAU

NEW

Repair Parts for Wall Mount Faucet with Soap Dish



- Repair parts for LynCar's popular 6" chrome plated cast body wall mounted faucet with soap dish (part#21815, page F-23)
- Replacement handles, cartridges and seats available

| part # | description |
|--------------|----------------|
| 33221 | Hot Cartridge |
| 33222 | Cold Cartridge |
| 33220 | Handles (pair) |
| 33225 | Seats (pair) |

Rubber Mallet



- 16oz, wood handle, white head

| part # | description |
|--------------|---------------------|
| 4008W | White rubber mallet |
| 4008 | Black rubber mallet |

"No-seize" Anti-Seize Lubricant and Thread Sealant



- Copper base, lead-free, anti-seize lubricant and thread sealant
- Conforms to MIL-A-907E specification
- Service rating to 1800° F (982° C).
- 10 oz brush top can

| part # | description |
|---------------|---------------------|
| 506061 | Anti-seize 10oz can |

HVAC Strap™

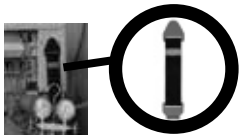

- Magnetic HVAC manifold gauge holder
- No more "hassle with the hook" - instead, hang your gauge manifold magnetically!
- Keep your gauges protected, available and readable

| part # | description |
|-------------|-------------|
| 4375 | HVAC Strap |

Hot Dam! Reusable Heat Sink Compound



- Use while soldering and brazing to prevent heat transfer along pipes and other metal surfaces, protecting critical components from heat damage
- Molds like clay, no drip or mess, and can be reused again

| part # | description |
|---------------|-------------|
| 999000 | 12oz. tub |

Ratchet Cutter for CPVC



- Premium duty stainless blade
- Cuts to 1-3/8" OD CPVC and other plastic pipe
- Replacement blade available

| part # | description |
|--------------|-------------------|
| 4685 | Heavy duty cutter |
| 4685B | Replacement blade |

NEW

AMERICAN STANDARD Ceramix Cartridge



- New style
- OEM ref#2023529-007

| part # | description |
|--------------|--------------------------|
| 2038 | Ceramix cartridge |
| 2038Q | Ceramix cartridge (bulk) |

AMERICAN STANDARD Flush Valve



- Tall flush valve assembly with actuator
- OEM ref#QH-3161

| part # | description |
|--------------|--------------------|
| 1034 | Flush valve |
| 1034Q | Flush valve (bulk) |

BELANGER Diverter Handle



- Chrome plated plastic lever handle for tub & shower diverter
- OEM ref#2200

| part # | description |
|--------------|------------------------|
| 8810 | Diverter handle |
| 8810Q | Diverter handle (bulk) |

BELANGER Cartridge



- For two handle dome/lever faucets, also fits CUTHBERT
- OEM ref#C-2

| part # | description |
|--------------|-----------------------|
| 9091 | Hot cartridge |
| 9091Q | Hot cartridge (bulk) |
| 9090 | Cold cartridge |
| 9090Q | Cold cartridge (bulk) |

BELANGER, PRICE PFISTER Ceramic Washerless Single Lever Cartridges



- Part#9092 for 4" centre set and 8" deck single lever faucets
- Part#9093 for 8" deck faucets with hose and spray (restricted flow)
- OEM ref#G-3

| part # | description |
|--------------|----------------------------------|
| 9092 | Free flow cartridge |
| 9092Q | Free flow cartridge (bulk) |
| 9093 | Restricted flow cartridge |
| 9093Q | Restricted flow cartridge (bulk) |

OEM (Original Equipment Manufacturer) numbers, registered / non registered trademarks, faucet name, and manufacturer listed above are supplied and listed for your reference only. All LynCar items are precision made and tested to the highest standards, by qualified factories inspected and approved by LynCar.

NOUVEAU

NEW

CUTHBERT Cartridge Assembly



- Fits hot & cold, for old style tub and shower
- OEM ref# MIV

| part # | description |
|--------------|---------------------------|
| 9045 | Cartridge assembly |
| 9045Q | Cartridge assembly (bulk) |

CUTHBERT / MUELLER Tub & Shower Flange



- Chrome plated
- OEM ref#145107

| part # | description |
|-------------|----------------------|
| 860 | Shower flange |
| 860Q | Shower flange (bulk) |

CUTHBERT NOVA BELANGER Handle



- Acrylic handle
- Hot / cold pair
- OEM ref#2900

| part # | description |
|-------------|-----------------------|
| 889 | Acrylic handle |
| 889Q | Acrylic handle (bulk) |

CUTHBERT Tub & Shower Sleeve



- Chrome plated
- OEM ref#1960-7

| part # | description |
|-------------|----------------------------|
| 865 | Tub & Shower sleeve |
| 865Q | Tub & Shower sleeve (bulk) |

OEM (Original Equipment Manufacturer) numbers, registered / non registered trademarks, faucet name, and manufacturer listed above are supplied and listed for your reference only. All LynCar items are precision made and tested to the highest standards, by qualified factories inspected and approved by LynCar.

NEW

EMCO Heavy Duty Cartridge



- For use with blade handles
- OEM ref#1556 (right) and ref#1557 (left)

| part # | description |
|--------------|------------------------|
| 9135 | Right cartridge |
| 9135Q | Right cartridge (bulk) |
| 9136 | Left cartridge |
| 9136Q | Left cartridge (bulk) |

EMCO Diverter Knob



- For facemount tub & shower
- OEM ref#51-192439

| part # | description |
|--------------|----------------------|
| 9140 | Diverter knob |
| 9140Q | Diverter knob (bulk) |

EMCO Cover Plate for Deck Faucet



- Chrome plated
- OEM ref#51-192859

| part # | description |
|--------------|--------------------|
| 9150 | Cover plate |
| 9150Q | Cover plate (bulk) |

EMCO Diverter Shroud & Sleeve



- Chrome plated plastic
- OEM ref#51-192932 and ref#51-195736

| part # | description |
|--------------|--------------------------------|
| 9145 | Diverter shroud & sleeve |
| 9145Q | Diverter shroud & sleeve(bulk) |

EMCO Institutional Cartridge



- For use with blade handles
- OEM ref#1456 (right) and #1457 (left)

| part # | description |
|--------------|------------------------|
| 9130 | Right cartridge |
| 9130Q | Right cartridge (bulk) |
| 9131 | Left cartridge |
| 9131Q | Left cartridge (bulk) |

OEM (Original Equipment Manufacturer) numbers, registered / non registered trademarks, faucet name, and manufacturer listed above are supplied and listed for your reference only. All LynCar items are precision made and tested to the highest standards, by qualified factories inspected and approved by LynCar.

NOUVEAU

NEW

GALTMASER Diverter Stem



- For tub & shower
- OEM ref#70184

| part # | description |
|-------------|-------------------------|
| 896 | Diverter assembly |
| 896Q | Dierter assembly (bulk) |

JAMECO handle

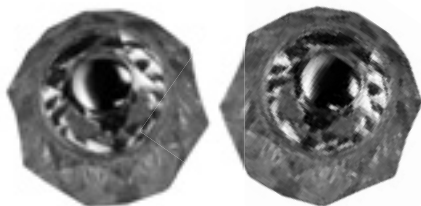

- Hot & cold pair
- Acrylic handle for Gemini
- OEM ref# 2371

| part # | description |
|---------------|------------------------|
| 12828 | Hot & cold pair |
| 12828Q | Hot & cold pair (bulk) |

Cartridge Clips for MOEN POSI-TEMP



- Holds the Posi-Temp cartridge (OEM ref#1222) in the faucet
- 25 to a pack

| part # | description |
|--------------|-----------------|
| 11257 | Cartridge clips |

MOEN Acrylic Knob



- Acrylic knob for single hand CHATEAU Posi-Temp tub & shower
- OEM ref#96884

| part # | description |
|---------------|---------------------|
| 11274 | Acrylic knob |
| 11274Q | Acrylic knob (bulk) |

MUELLER Stem



- Fits MUELLER, NOVA, NASSAU and NIAGARA tub & shower
- OEM ref#145139 (right/hot) and #145141 (left/cold)

| part # | description |
|--------------|------------------|
| 9035 | Hot stem |
| 9035Q | Hot stem (bulk) |
| 9036 | Cold stem |
| 9036Q | Cold stem (bulk) |

OEM (Original Equipment Manufacturer) numbers, registered / non registered trademarks, faucet name, and manufacturer listed above are supplied and listed for your reference only. All LynCar items are precision made and tested to the highest standards, by qualified factories inspected and approved by LynCar.

NEW

MUELLER Tub & Shower Sleeve



- Chrome plated
- OEM ref#145108

| part # | description |
|--------------|----------------------|
| 9020 | Shower sleeve |
| 9020Q | Shower sleeve (bulk) |

MAGICLOSE Cartridge



- Self-closing cartridge for MAGICLOSE
- For hot & cold
- OEM ref#354020 / #039051

| part # | description |
|--------------|------------------|
| 9280 | Cartridge |
| 9280Q | Cartridge (bulk) |

Flush Valve Diaphragm for SLOAN / ZURN



- Replaces A-156A diaphragm for SLOAN / ZURN
- OEM ref#0301188

| part # | description |
|---------------|------------------|
| 32924 | Diaphragm |
| 32924Q | Diaphragm (bulk) |

VALLEY Tub & Shower Handle



- Acrylic handle for new style
- OEM ref#V5013BG

| part # | description |
|--------------|-----------------------|
| 7062 | Acrylic handle |
| 7062Q | Acrylic handle (bulk) |

VALLEY II Handle



- Crystal handle for VALLEY II two handle faucets
- Hot / Cold pair
- OEM ref#7800

| part # | description |
|--------------|------------------------|
| 7061 | Hot / cold pair |
| 7061Q | Hot / cold pair (bulk) |

OEM (Original Equipment Manufacturer) numbers, registered / non registered trademarks, faucet name, and manufacturer listed above are supplied and listed for your reference only. All LynCar items are precision made and tested to the highest standards, by qualified factories inspected and approved by LynCar.

NEW

Quick Rinse Head - Black



| part # | description |
|--------------|-------------------------|
| 1179 | Quick rinse head |
| 1179Q | Quick rinse head (bulk) |

Pull-Out Faucet Spray Head - Chrome



| part # | description |
|--------------|-------------------|
| 1180 | Spray head |
| 1180Q | Spray head (bulk) |

WALLACEBURG Diverter Assembly



- For Jubilee W5700 tub & shower
- OEM ref#W3281

| part # | description |
|--------------|-------------------------|
| 9392 | Diverter assembly |
| 9392Q | Dierter assembly (bulk) |

WALTEC Diverter Assembly



- For STARBURST concealed tub & shower 1970-74
- OEM ref#T25159

| part # | description |
|--------------|--------------------------|
| 9640 | Diverter assembly |
| 9640Q | Diverter assembly (bulk) |

WALTEC Tub Spout Nipple



- 1/2" x 5-1/4"
- OEM ref#T3774

| part # | description |
|--------------|-------------------------|
| 1108 | Tub spout nipple |
| 1108Q | Tub spout nipple (bulk) |

OEM (Original Equipment Manufacturer) numbers, registered / non registered trademarks, faucet name, and manufacturer listed above are supplied and listed for your reference only. All LynCar items are precision made and tested to the highest standards, by qualified factories inspected and approved by LynCar.

NEW

LYNCAR Push-Fit Fittings - New Sizes



NOUVEAU



part#1375049LF



part#1375370LF



part#1375168LF



part#1375642LF



part#1375648LF



part#1375910LF



part#1375912LF

- Our popular push fitting line is now all lead-free and we have added some new items

| part # | description |
|------------------|----------------------------------|
| 1375049LF | Reducing coupling 3/4" x 1" MNPT |
| 1375370LF | Drop ear elbow 3/4" x 1/2" FNPT |
| 1375168LF | Elbow 3/4" x 1" |
| 1375642LF | Elbow connector 1/2" x 1/2" MPT |
| 1374648LF | Elbow connector 3/4" x 3/4" MPT |
| 1375910LF | Angle Valve 1/2" x 1/2" |
| 1375912LF | Straight Valve 1/2" x 1/2" |

OEM (Original Equipment Manufacturer) numbers, registered / non registered trademarks, faucet name, and manufacturer listed above are supplied and listed for your reference only. All LynCar items are precision made and tested to the highest standards, by qualified factories inspected and approved by LynCar.

Copyright© 03-2016

NEW DRAIN SNAKE SPECIALTIES

LynCar is please to offer our new line of replacement drain snake heads for RIDGID™ and GENERAL WIRE™ drain cleaning machines, as well as related accessories. Our products are made to exacting standards to get the toughest jobs done.

REPLACEMENT HEADS FOR RIDGID™

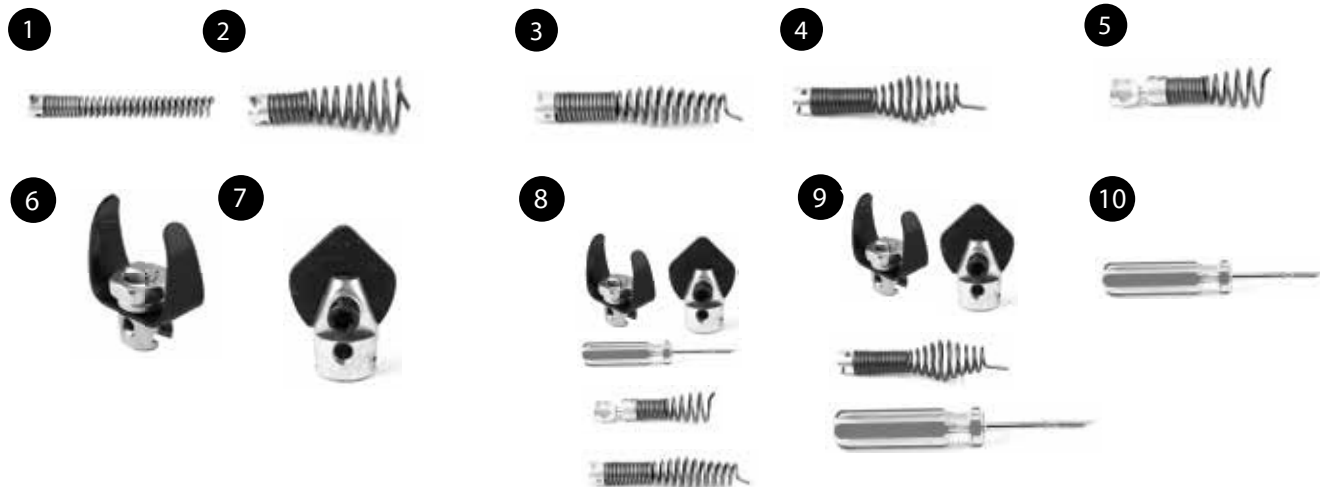

| Part# | Photo# | Description | Replaces OEM Part# |
|---------|--------|---|--------------------|
| 983T201 | 1 | 5" Straight Auger for 5/16", 3/8", 1/2" and 5/8" Cables (for K-50 Sectional Machine and K-400 & K-3800 Drum Machines) | T-201 |
| 983T206 | 2 | 3" Funnel Auger for 5/16", 3/8", 1/2" and 5/8" Cables (for K-50 Sectional Machine and K-400 & K-3800 Drum Machines) | T-206 |
| 983T203 | 3 | 7/8" Bulb Auger for 5/16", 3/8", 1/2" and 5/8" Cables (for K-50 Sectional Machine and K-400 & K-3800 Drum Machines) | T-203 |
| 983T202 | 4 | 1 1/8" Bulb Auger for 5/16", 3/8", 1/2" and 5/8" Cables (for K-50 Sectional Machine and K-400 & K-3800 Drum Machines) | T-202 |
| 983T217 | 5 | 4" Drop Head for 5/16", 3/8", 1/2" and 5/8" Cables (for K-50 Sectional Machine and K-400 & K-3800 Drum Machines) | T-217 |
| 983T205 | 6 | 1-3/8" C-Cutter for 5/16", 3/8", 1/2" and 5/8" Cables (for K-50 Sectional Machine and K-400 & K-3800 Drum Machines) | T-205 |
| 983T210 | 7 | 1" Spade Cutter for 5/16", 3/8", 1/2" and 5/8" Cables (for K-50 Sectional Machine and K-400 & K-3800 Drum Machines) | T-210 |
| 983T211 | 7 | 1-3/8" Spade Cutter for 5/16", 3/8", 1/2" and 5/8" Cables (for K-50 Sectional Machine and K-400 & K-3800 Drum Machines) | T-211 |
| 983T250 | 8 | 5 Piece Kit for 5/8" Cables includes: 7/8" Bulb Auger, 1-3/8" C-Cutter, 1" Spade Cutter, 4" Drop Head and Pin key | T-250 |
| 983T260 | 9 | 4 Piece Kit for 3/8" Cables includes: 1-1/8" Bulb Auger, 1-3/8" C-Cutter, 1-3/8" Spade Cutter and Pin key | T-260 |
| 983TA13 | 10 | Pin Key for Ridgid™ - style heads | A-13 |

UGLY GLOVE



- Design prevents gloves from getting pinched between coils of cable
- Provides maximum abrasion resistance
- Blend of PVC/NBR chips to prevent slipping
- Chemically resistant
- Available in either cuffed wrist or mid-forearm lengths

| Part# | Description |
|---------|--------------|
| 9834100 | Cuffed wrist |
| 9834112 | Mid-Forearm |

NEW

NEW DRAIN SNAKE SPECIALTIES

LynCar is please to offer our new line of replacement drain snake heads for RIDGID™ and GENERAL WIRE™ drain cleaning machines, as well as related accessories. Our products are made to exacting standards to get the toughest jobs done.

REPLACEMENT HEADS FOR GENERAL WIRE™

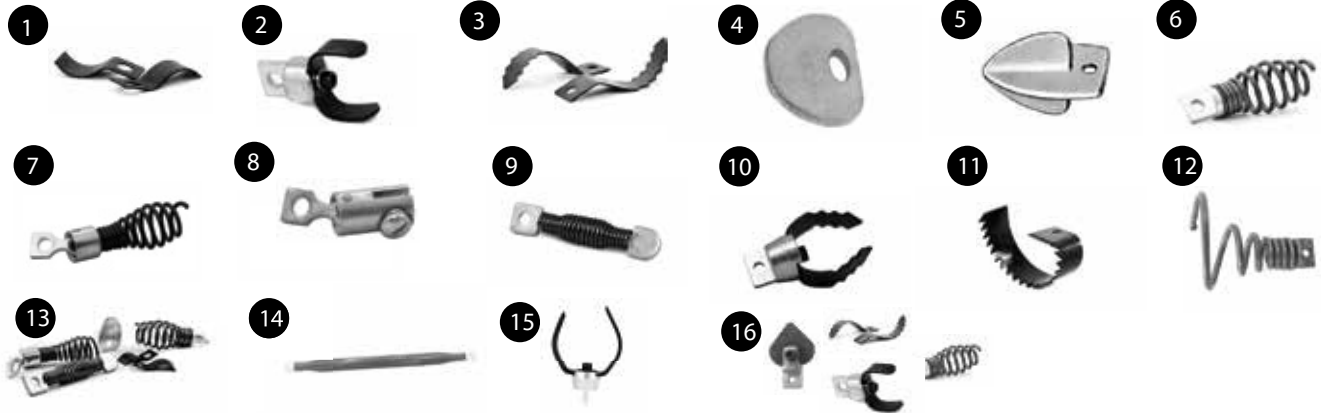

NOUVEAU

| Part# | Photo# | Description | Replaces OEM Part# |
|--------|--------|--|--------------------|
| 983G04 | 1 | 1-1/4" Side Cutter Blades for 3/8" Cables (Pair) | 1-1/4SCB |
| 983G08 | 2 | 1-1/2" U-Cutter for 3/8" and 1/2" Cables | 1-1/2UC |
| 983G09 | 3 | 2" Cable Side Cutter Blades for 1/2", 5/8" and 3/4" Cables (Pair) | 2SCB |
| 983G21 | 3 | 3" Cable Side Cutter Blades for 1/2", 5/8" and 3/4" Cables (Pair) | 3SCB |
| 983G22 | 3 | 4" Cable Side Cutter Blades for 1/2", 5/8" and 3/4" Cables (Pair) | 4SCB |
| 983G01 | 4 | Arrowhead Starting Drill for 3/8" and 1/2" Cables | AH |
| 983G16 | 5 | Spearhead Starting Drill for 5/8" and 3/4" Cables | SHD |
| 983G02 | 6 | Boring Gimlet for 3/8" and 1/2" Cables | BG |
| 983G03 | 7 | Drop Head Boring Gimlet for 3/8" Cables | DHBG |
| 983G38 | 8 | Drop Head Fitting for 3/8" Cables | DHF |
| 983G05 | 9 | Flexible Arrowhead for 3/8" and 1/2" Cables | FAH |
| 983G17 | 10 | 2" U-Cutter for 3/8", 1/2", 5/8" and 3/4" Cables | 2UC |
| 983G18 | 10 | 3" U-Cutter for 5/8" and 3/4" Cables | 3UC |
| 983G19 | 10 | 4" U-Cutter for 5/8" and 3/4" Cables | 4UC |
| 983G24 | 11 | 3" Rotary Saw Blades for 1/2", 5/8" and 3/4" Cables (Pair) | 3RSB |
| 983G25 | 11 | 4" Rotary Saw Blades for 5/8" and 3/4" cables (pair) | 4RSB |
| 983G13 | 12 | Small Corkscrew Retrieving Tool for 3/8", 1/2", 5/8" and 3/4" Cables | RTR1 |
| 983G06 | 13 | Handy electric 5 Piece Cutter Set - Arrowhead, Flex Arrowhead, Boring Gimlet, Downhead Boring Gimlet and 1-1/4" Sidecutter | HECS |
| 983G07 | 14 | 13" Flexible Leader | LE-1 |
| 983G30 | 15 | 3" Heavy Duty Side-Cutter for 5/8" and 3/4" Cable | 3HDSC |
| 983G55 | 16 | Mini-Rooter 4 Pc Cutter Set - Arrowhead, Boring Gimlet, 2" Cable Sidecutter Blades & 1-1/2" U-Cutter | MRCS |

GEN-RID ADAPTER



- The "GEN-RID" Adaptor enables RIDGID™ heads to be used on General Wire™ cables, and vice versa
- Made of tempered steel
- Comes with RIDGID™ pin key
- Fits 5/16", 3/8" and 1/2" cables

| Part# | Description |
|---------|-----------------|
| 983PS23 | GEN-RID Adaptor |

NEW PLUMBING SPECIALTIES

SHOTGUN SPRINKLER HEAD SHUTOFF TOOL



- Shuts off activated fire sprinkler heads instantly
- Minimizes water damage
- Ideal for hotels, hospitals, universities and other commercial property

| Part# | Description |
|-------|-----------------------------|
| 99SG1 | Sprinkler Head Shutoff Tool |

NEW 2" FLOOD GUARD



- our popular flood guard now available in 2" (as well as 3" and 4")
- brass body with rubber outer
- box packaged

| Part# | Description |
|-------|-------------|
| 11402 | 2" |
| 11400 | 3" |
| 11405 | 4" |

GREEN BLASTER DRAIN OPENER



- Now available in 6 lb container
- Green-Blaster is a dry, granular drain opener for clearing grease, hair and other organic matter from drains
- Small granular beads feed directly to clog, destroying hair and grease instantly
- Odor free
- Will not harm chrome, polished brass or plastic
- Safe for septic systems, drains, grease traps and root control
- Green Blaster is simple to use – just pour 1/2 cup of the beads into the drain, run warm (not boiling) water for long enough to dissolve the beads, then cover the drain opening with a wet rag and wait 60 seconds and flush with more warm water. Then repeat one more time.
- Wear safety goggles and rubber gloves.

| Part# | Description |
|-------|-------------|
| 59005 | 16oz |
| 59007 | 6lb |

NEW

NEW PLUMBING SPECIALTIES

MAXPOWER HEAVY DUTY 4" PIPE CUTTER



- New and improved reliability and durability
- Cuts steel pipe with OD of 1-1/4" to 4"
- Has auxiliary shaft to balance pressure and force on both sides of pipe

| Part# | Description |
|--------|---------------|
| MP4000 | Heavy Duty 4" |

AIR POWERED DRAIN CLEANER



- Powerful air pump for drain cleaning
- Pump up the pressure to as much as 60PSI (10.4MPA), then release with the "trigger"
- Reversible rubber adapter is suitable for different drain sizes

| Part# | Description |
|--------|---------------------------|
| 981GQ4 | Air powered drain cleaner |

HYDRO TRACE LEAK DETECTOR



- designed specifically to locate hard-to-find leaks in any closed system containing water and/or antifreeze compounds such as Propylene Glycol and Ethylene Glycol
- chemically inert and will not harm equipment or seals
- Locates leaks exactly, never a false positive
- When HYDRO TRACE is added to a system leaks are easily visible as bright red stains under normal lighting conditions and as a bright orange glow when exposed to an ultraviolet light source
- Can be used in refrigeration, hydronics, automotive and process cooling

| Part# | Description |
|--------|-------------|
| 506001 | 4 oz bottle |

NOUVEAU

NEW PLUMBING SPECIALTIES

BIG WIPES



- three layered non-woven textile with quilted textured surface provides super strength, superior dirt absorption, high tear resistance and is lint free
- Removes paint, adhesives, silicone, epoxy, PU foam, oil, grease and more from hands, tools and surfaces
- Anti-bacterial , and provides 99+% effectiveness against against MRSA, C.Dif., E-Coli 157, Weils (from rats), Salmonella, Staphylococcus and Listeria
- Zero levels of irritation recorded in controlled testing by dermatologists

| Part# | Description |
|-------|-----------------|
| 59078 | Can of 72 wipes |

Q-TURN VALVES FOR COLD EXPANSION



- For ASTM F1960 systems
- 1/2" cold expansion x 3/8" compression quarter turn stop valves
- Available in straight and angle
- For use with the Wirsbo™ pex connection system supplied by Uponor

| Part# | Description |
|---------|-------------|
| 33441LF | straight |
| 33461LF | angle |

GOBIDET™ HANDHELD BIDET



- Simple to install on any toilet
- Water supply comes from easy-to-install diverter on toilet water supply hose
- Includes spray unit, hose, diverter valve and hanging unit

| Part# | Description |
|-------|-------------------------|
| 2012W | GoBidet™ Handheld Bidet |

NEW PLUMBING SPECIALTIES

NOUVEAU

SIZE ALL STRAIGHT PEX CRIMPING TOOL



- one tool for crimping 1/2", 3/4" and 1" copper rings
- the tool is a 1" crimper with spring-loaded 1/2" and 3/4" interchangeable dies that can be switched
- housed in convenient carrying case that attaches to the tool - 1 set of 3/4" dies and 2 sets of 1/2" dies are included
- 14" composite handle, 4 lb. weight
- Additional replacement dies available
- Made in the USA

| Part# | Description |
|----------------|--|
| 9314-1 | Straight PEX crimping tool with interchangeable dies |
| 9314R12 | Replacement 1/2" dies |
| 9314R34 | Replacement 3/4" dies |

SIZE ALL ANGLE PEX CRIMPING TOOL



- one tool for 1/2" and 3/4" copper rings
- tool is a 3/4" angle crimper with spring-loaded 1/2" die that can be switched in seconds
- 1/2" dies are housed in a secure rubber ring attached to the tool
- 12" length with plastic-covered steel handles, 2.3 lb weight
- Replacement 1/2" dies are available
- Made in the USA

| Part# | Description |
|----------------|---|
| 9316 | Angle PEX crimping tool with interchangeable dies |
| 9316R12 | Replacement 1/2" dies |

WINGTITE SHOWER DRAIN



- Replace the drain, not the shower
- Allows drain replacement with top access only, no bottom access required and no need to tear out the shower
- Fits 2" ABS or PVC pipe
- Repairs done in 30 minutes
- See how it works – watch the video at www.wingtite.com

| Part# | Description |
|---------------|--------------|
| SD1000 | Shower Drain |

NEW TOILET REPAIR

CLEAR CONE FLAPPER FOR TOTO™



- Replaces OEM ref# THU303

| Part# | Size |
|-------|--------------------|
| 10147 | Clear Cove Flapper |

PERFECT SEAL™ TOILET FLANGE



- Plastic flange with attached wax ring, embedded in a rubber shield to eliminate mess
- Creates the perfect seal for any flange height, from 1/2" above the floor to 1-1/2" below the floor
- Works with any drain size or toilet installation

| Part# | Description |
|-------|---------------|
| 10718 | Toilet Flange |

HYDROSEAT™ TOILET FLANGE REPAIR KIT



- Steel toilet flange with attached closet bolts and deep rubber drain funnel
- Repairs damaged closet flange and fixes wobbly toilets
- Works with wax ring (not included)
- Fits any pipe, toilet or collar size

| Part# | Description |
|-------|---------------|
| 10672 | Toilet Flange |

THE "LID LOCK-OUT" TOILET PROTECTOR



- many toilets are destroyed every year by vandals who throw debris into the tank - prevent this problem with the Toilet Protector
- curved stainless steel plate attached to the wall with screws secures the tank lid
- plastic jam protects the tank from scratches
- will also protect urinal fill valves
- chrome or white

| Part# | Description |
|--------|-------------|
| 10229 | Chrome |
| 10229W | White |

NEW TOILET REPAIR

KORKY™ ULTRA WATERSAVER FLAPPER



- Universal, adjustable 2" flapper
- Adjustable to optimize flush - the dial on the bottom of the flapper enables you to control the timing of the flapper closing, for a perfect flush every time
- Instructions specify optimum settings for leading OEM toilets including TOTO, KOHLER and AMERICAN STANDARD
- Works on all tank sizes: 1.28, 1.6, 3.5 & 5 gallons per flush
- Premium red Chlorazone rubber resists chlorine
- Five year guarantee

| Part# | Description |
|--------------|---------------------------------|
| 100BP | KORKY™ Ultra Watersaver Flapper |

VORTENS TANK LEVERS



- Stronger than the OEM
- For Vortens Vienna, OEM ref#V191-S
- white or polished chrome

| Part# | Description |
|--------------|-----------------|
| 18611 | white |
| 18811 | polished chrome |

FLAPPER FOR ELJER™



- 2", SSD Chain, with large hole and baffle
- Replaces OEM ref# 495-6072-00

| Part# | Description |
|--------------|-------------------|
| 10149 | Flapper for ELJER |

SUPERCHARGED FLUSH VALVE



- upgrades most older problematic 2" 1.6 GPF toilets to the powerful flush technology of newer 3" toilets
- works on KOHLER™, AMERICAN STANDARD™, ELJER™, TOTO™, MANSFIELD™ and more!
- includes all the parts you need including a KOHLER™-style Class V flapper, flush valve seal, sponge tank-to-bowl gasket, and over-sized overflow tube

| Part# | Description |
|-------------|--------------------------|
| 1016 | Supercharged Flush Valve |

OFFSET TANK LEVER FOR WESTERN POTTERY



- Chrome handle
- Now available in plastic arm
- Brass version is LynCar part 1058

| Part# | Description |
|--------------|-------------------|
| 10581 | Offset Tank Lever |

NEW RESIDENTIAL FAUCET & SHOWER REPAIR

2" CERAMIC CARTRIDGE - FOR AMERICAN STANDARD™



- For centreset and widespread lav faucets, Monterrey collection
- Also fits some wall mount service sink faucets
- 2" Hot & Cold with Square Broach
- Replaces OEM ref# 951764-0070A

| Part# | Description |
|-------|----------------------|
| 9094 | 2" Ceramic Cartridge |

2-13/16" CERAMIC CARTRIDGE - FOR AMERICAN STANDARD™



- For centreset and widespread lav faucets, Williamsburg collection
- 2-3/16" 18 Spline Broach Hot & Cold
- Replaces OEM ref# 994053-0070A

| Part# | Description |
|-------|----------------------------|
| 9095 | 2-13/16" Ceramic Cartridge |

MULTI-FIT PRESSURE BALANCED CARTRIDGE FOR AMERICAN STANDARD



- Cartridge comes with three adapter plates, to produce a full replacement cartridge unit for any of Colony (OEM ref# M952100-0070A), Ultramix (OEM ref# 077171-0070A) or Reliant (OEM ref# 51091-007A) shower models
- Saves a 2nd trip to the wholesaler - this 3-in-1 kit ensures you have the right replacement pressure balanced cartridge every time

| Part# | Description |
|-------|---|
| 70831 | Multi-Fit Pressure Balanced Cartridge for American Standard |

CERAMIC DISC CARTRIDGE FOR AMERICAN STANDARD



- Cartridge with handle adapter bushing
- For Colony dual control T&S
- Replaces OEM ref# 954120-0070A

| Part# | Description |
|-------|------------------------|
| 7084 | Ceramic Disc Cartridge |

ULTRA-MIX CANOPY HANDLE FOR AMERICAN STANDARD



- Fits OEM ref# 066-269-0070A cartridge, and plates OEM ref# 66270-0020A and OEM ref# 21467-0020A

| Part# | Description |
|-------|-------------------------|
| 7085 | Ultra-Mix Canopy Handle |

NEW RESIDENTIAL FAUCET & SHOWER REPAIR

2-1/4" CERAMIC CARTRIDGE - FOR CHICAGO™



- 2-1/4" Ceramic Cartridge for Chicago™
- For most 2-handle faucets, short stem
- Replaces Hot OEM ref# 1-100XKJKNF and Cold OEM ref# 1-099XKJKNF

| Part# | Description |
|-------|-------------|
| 9021 | Hot |
| 9022 | Cold |

2-7/8" CERAMIC CARTRIDGE - FOR CHICAGO™



- 2-7/8" Ceramic Cartridge for Chicago™
- For long stem two handle faucets
- Replaces Hot OEM ref# 377-XKLHJKNF and Cold OEM ref# 377-XKRHJKNF

| Part# | Description |
|-------|-------------|
| 9023 | Hot |
| 9024 | Cold |

LONG SEAT - FOR CUTHBERT NOVA AND BELANGER



- 9/16" 24 TPI
- Fits BELANGER and NOVA tub & shower 1960-74
- comes in packaged pairs or bulk

| Part# | Description |
|--------|-------------|
| 12823 | Long Seat |
| 12823Q | bulk |

"STOP PLUS" KIT FOR DANFOSS TEMPRESS II AND MORE



- 8-piece parts kit for Tempress II and other popular shower valves
- also fits EMCO, GERBER, GROHE, DORNBRACHT, ELJER and more

| Part# | Description |
|-------|--|
| 9122 | "Stop Plus" Kit for Danfoss Tempress II and More |

DANFOSS TEMPRESS II ESCUTCHEON HANDLE DRIVE ASSEMBLY



- fits handle to cartridge

| Part# | Description |
|-------|--|
| 9121 | Danfoss Tempress II Escutcheon Handle Drive Assembly |

NEW RESIDENTIAL FAUCET & SHOWER REPAIR

TUB & SHOWER FLANGE AND SLEEVE FOR EMCO™



part#11288



part#11289

- Concealed chrome-plated sleeve and flange
- Replaces OEM ref# 51-176219 (sleeve) and OEM ref# 51-192864 (flange)

| Part# | Description |
|---------------|--------------------------|
| 11288 | Tub & Shower Flange |
| 11288Q | Tub & Shower Flange bulk |
| 11289 | Tub & Shower Sleeve |
| 11289Q | Tub & Shower Sleeve bulk |

REPLACEMENT FAUCET CARTRIDGES FOR GLACIER BAY™



part#18565
part#18564



part#18566
part#18567



part#18568
part#18569

- Parts 18564 and 18565 replace OEM ref# 35-11 hot and cold, for faucet models 102-823, 102-856 and 351-040
- Parts 18566 and 18567 replace OEM ref# 35-10 hot and cold. for faucet models 813-452, 866, 941, 946, 971 and 973
- Parts 18568 and 19569 replace OEM ref# 35-12 hot and cold, for faucet models 170-371, 174-138, 174-239 and 503-334

| Part# | Description |
|--------------|-----------------------------------|
| 18565 | Cold Cartridge for OEM ref# 3S-11 |
| 18564 | Hot Cartridge for OEM ref# 3S-11 |
| 18567 | Cold Cartridge for OEM ref# 3S-10 |
| 18566 | Hot Cartridge for OEM ref# 3S-10 |
| 18569 | Cold Cartridge for OEM ref# 3S-12 |
| 18568 | Hot Cartridge for OEM ref# 3S-12 |

REPLACEMENT CARTRIDGE FOR GLACIER BAY™ TUB & SHOWER



- FOR GLACIER BAY, AQUASOURCE, PEGASUS and DANZE single handle tub and shower
- Fits many models

| Part# | Description |
|--------------|-----------------------|
| 18570 | Replacement Cartridge |

NEW RESIDENTIAL FAUCET & SHOWER REPAIR

REPLACEMENT CARTRIDGE FOR GLACIER BAY™ SINGLE HANDLE FAUCETS



- FOR GLACIER BAY and AQUASOURCE
- Ceramic cartridge for single handle lav faucets
- For OEM models 169-640, 704-612, 704-615 and more

| Part# | Description |
|--------------|---|
| 18571 | Replacement Cartridge for Single Handle Faucets |

BRASS ELONGATED SEAT FOR JAMECO T&S



- 1/2" - 20 TPI, replaces OEM ref# 1103

| Part# | Description |
|---------------|--|
| 12819 | Brass elongated seat for Jameco T&S |
| 12819Q | Brass elongated seat for Jameco T&S bulk |

2-1/16" CERAMIC CARTRIDGE - FOR KOHLER™



- Fits most lav faucets after 1990
- 2-1/16" Ceramic Stem with 20 Spline Broach
- Replaces OEM ref# 6P77005 (hot) and 6P7706 (cold)

| Part# | Description |
|-------------|-------------|
| 9080 | Hot |
| 9081 | Cold |

2-1/2" CERAMIC CARTRIDGE - FOR KOHLER™



- 2-1/2" Compression Stem
- Replaces Hot OEM ref# GP3002 and cold OEM ref# GP3004
- For Aterna, cancellation and Triton models

| Part# | Description |
|-------------|-------------|
| 9082 | Hot |
| 9083 | Cold |

CARTRIDGE CLIPS FOR MOEN POSI-TEMP™

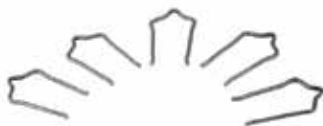

- New style
- Fits OEM cartridge ref# M0541222B
- come in pack of 5

| Part# | Size |
|--------------|-----------------|
| 11257 | Cartridge Clips |

OEM (Original Equipment Manufacturer) numbers, registered / non registered trademarks, faucet name, and manufacturer listed above are supplied and listed for your reference only. All LynCar items are precision made and tested to the highest standards, by qualified factories inspected and approved by LynCar.

NOUVEAU

NEW RESIDENTIAL FAUCET & SHOWER REPAIR

**HOT & COLD CERAMIC CARTRIDGE - FOR PRICE
PFISTER™**



- For Savannah collection pre-2005
- 1-13/16" Ceramic Cartridge for hot & cold
- Replaces OEM ref# 910-900
- for Two-Handle Lav Faucets

| Part# | Description |
|-------|------------------------------|
| 9086 | Hot & Cold Ceramic Cartridge |

**OLD STYLE CERAMIC CARTRIDGE - FOR PRICE
PFISTER™**



- For Savannah collection post 2005
- Old Style 2" Plastic Ceramic Cartridge
- Replaces Hot OEM ref# 910-031/910-024 and Cold OEM ref# 910-032 / 910-025

| Part# | Description |
|-------|-------------|
| 9087 | Hot |
| 9088 | Cold |

**TUB & SHOWER CERAMIC STEM - FOR PRICE
PFISTER™**



- For Series 01, 03, 05, and 07
- 4-1/2" Hot & Cold Ceramic Stem for tub and shower
- Replaces OEM ref# 910-030

| Part# | Description |
|-------|--------------------------|
| 9089 | Replaces OEM ref#910-030 |

**"HOLD DOWN" FOR TUB & SHOWER - REPLACEMENT
PART FOR WALTEC**



- For tub & shower
- chrome plated
- Replaces OEM ref# 16398

| Part# | Description |
|--------|-----------------------------------|
| 11284 | "Hold Down" for Tub & Shower |
| 11284Q | "Hold Down" for Tub & Shower bulk |

**TUB & SHOWER FLANGE - REPLACEMENT PART
FOR WALTEC**



- chrome plated
- replaces OEM ref# 16417

| Part# | Description |
|-------|---------------------|
| 11282 | Tub & Shower Flange |

NEW RESIDENTIAL FAUCET & SHOWER REPAIR

11" TUBULAR SPOUT FOR WALTEC™



- chrome plated with regulator aerator
- OEM ref# 76545-1

| Part# | Size |
|-------|--------------------|
| 1176 | Tubular Spout |
| 1176Q | Tubular Spout bulk |

14" TUBULAR SPOUT FOR WALTEC™



- chrome plated with regular aerator
- new style with nylon ring
- OEM ref# 76546-1

| Part# | Size |
|-------|--------------------|
| 1217 | Tubular Spout |
| 1217Q | Tubular Spout bulk |

DUAL THREAD AERATOR WITH PAUSE



- Flow Rate: 5.7 LPM (1.5 GPM)
- Patented flow compensator gives consistent flow regardless of available water pressure
- Pause action reduces flow to a trickle while keeping temperature consistent
- Control from soft spray to solid stream, with up-and-down action to change spray settings
- Dual-thread aerator to fit both male and female faucets
- Meets or exceeds ASME standards.
- Connector is chrome finished, aerator is black and white 360° swivel action for directional spray and convenience

| Part# | Description |
|-------|--------------------------------|
| 2169 | Dual Thread Aerator With Pause |

FAUCET SEAT KIT - 140 PIECES



- 10 Am/St Aquaseal - Part 2034
- 10 CUTHBERT Faucet Brass Seat 9/16 x 24 TPI - Part 12825
- 10 Emco T&S Seat - Part 923
- 20 EMCO Faucet Brass Seat ~ 9/16 x 27 TPI - Part 12820
- 10 MIXET Replacement Seat MS105 - Part 13028
- 10 MUELLER Seat 17/32 x 24 TPI - Part 9031
- 10 STERLING Seat 1/2 x 24 TPI - Part 9480
- 10 WALTEC Long Tub & Shower Seats 9/16 x 24TPI - Part 9478
- 20 WALTEC Faucet Brass Seats 9/16 x 24 TPI - Part 947
- 10 PRICE PFISTER Seat 21/32 x 18TPI - Part 21500
- 10 PRICE PFISTER Seat 1/2 x 20TPI - Part 21502
- 10 JAMECO Faucet Seat 1/2 x 20 TPI - Part 12822

| Part# | Description |
|-------|------------------------------|
| 2257 | Faucet Seat Kit - 140 Pieces |

QUICK DECK BATHROOM PLATE



- a new versions LynCar's popular deck repair plate, sized for bathroom faucets
- 14 gauge galvanized steel plate with holes sized for 4" faucets
- Provides a solid foundation for worn-out counters and vanities

| Part# | Description |
|--------|---------------------------|
| 12144R | Quick Deck Bathroom Plate |

OEM (Original Equipment Manufacturer) numbers, registered / non registered trademarks, faucet name, and manufacturer listed above are supplied and listed for your reference only. All LynCar items are precision made and tested to the highest standards, by qualified factories inspected and approved by LynCar.

NEW COMMERCIAL FAUCET & FLUSH VALVE REPAIR

URINAL CLEANOUT COVERS



- Plug available in 1-1/2" to 4" sizes.
- Face plates in either 4" regular size or 5" large size
- Comes with tightening screw
- We can customize any size plug with face plates from 3" to 8" - call our order desk

| Part# | Description |
|-------|---------------------------|
| 4847 | 1-1/2" Regular - 4" plate |
| 4848 | 2" Regular - 4" plate |
| 4849 | 3" Regular - 4" plate |
| 4850 | 4" Regular - 4" plate |
| 4851 | 1-1/2" Large - 5" plate |
| 4852 | 2" Large- 5" plate |
| 4853 | 3" Large- 5" plate |
| 4654 | 4" Large- 5" plate |

UNIVERSAL REPAIR PARTS FOR FLUSH VALVES



- Universal stainless steel pre-filter made with superior TPR material
- Works with all urinal and closet flush valves .5 thru 4.5 GPF, including SLOAN, ZURN, DELANEY, CRANE, TECK AND DELTA
- 3/4" slip joint washer with friction ring fits almost all OEM urinal tubes made of superior TPR material, will not self-destruct like the OEM and nearly seals itself!

| Part# | Description |
|-------|--------------------------------------|
| 32919 | Universal Pre-Filter |
| 32921 | Slip-Joint Washer with Friction Ring |

PARTS FOR BRADLEY FOOT VALVE



- all parts interchange and made of same material as BRADLEY OEM ref#P035-652, and each part is individually tested
- brass body, arm & seat
- Made in USA
- two repair kits available, for pre and post 2003 OEM models

| Part# | Description |
|-------|--|
| 9007 | repair kit for pre-2003 BRADLEY models |
| 9008 | repair kit for models since 2003 |

NEW COMMERCIAL FAUCET & FLUSH VALVE REPAIR

BUBBLER CARTRIDGE - FOR CRANE



- Replaces OEM 355174/039052

| Part# | Description |
|----------------|------------------------|
| 2200LF | Bubbler Cartridge |
| 2200LFQ | Bubbler Cartridge bulk |

HOSPITAL CARTRIDGE - REPLACES CRANE



- Left (hot) OEM ref#354013 / 039064
 - Right(cold) OEM ref#354014 / 039065

| Part# | Description |
|-----------------|--------------------------------------|
| 11199LFQ | left (hot)hospital cartridge |
| 11200LFQ | left (hot)hospital cartridge bulk |
| 11200LF | right (cold) hospital cartridge |
| 11200LFQ | right (cold) hospital cartridge bulk |

GASKET SHEETS



- 6" x 6" sheets for making your own gaskets
 - Available in cork, black neoprene and compressed fibre

| Part# | Description |
|--------------|------------------------|
| 12618 | Cork 1/8" |
| 12619 | Cork 1/16" |
| 12620 | Black Neoprene 1/32" |
| 12621 | Compressed Fibre 1/16" |

SPINDLE REBUILD KIT FOR T&S BRASS ETERNA



- For rebuilding T&S Brass Eterna handle assemblies with OEM 002713-40 and 002714-40

| Part# | Description |
|--------------|---------------------|
| 33326 | Spindle Rebuild Kit |

OEM (Original Equipment Manufacturer) numbers, registered / non registered trademarks, faucet name, and manufacturer listed above are supplied and listed for your reference only. All LynCar items are precision made and tested to the highest standards, by qualified factories inspected and approved by LynCar.

NOUVEAU

NEW FROM WATERLINE

POW-R WRAP



- specially formulated fiberglass tape - just add water and wrap performs repairs in minutes with no tools required
- tested to 300 PSI
- can be applied to all types of pipes including PVC, cast iron, galvanized, and clay
- approved in the US for use on drinking water lines as well as being suitable for sewer, irrigation and chemical lines

| Part# | Tape Length | Use on Pipe Diameter |
|----------------|-------------|----------------------|
| 1630130 | 1" x 30" | 1/4" - 1/2" |
| 1630230 | 2" x 30" | 3/4" - 1" |
| 1630260 | 2" x 60" | 1-1/2" |
| 1633108 | 3" x 108" | 2" - 3" |
| 1634180 | 4" x 180" | 6" |
| 1634360 | 4" x 360" | 8" |

COPPER CLAD STUBOUT BRACKET



- copper plated
- 3/4" x 20" 16ga

| Part# | Description |
|----------------|-----------------------------|
| 1481000 | Copper Clad Stubout Bracket |

GAS CONNECTOR HOSES - FOR RANGE AND DRYER



- yellow coated
- 5/8" OD (1/2" ID)
- corrugation extends all the way to the connection, which provides resistance to kinking
- for similar applications as Dormont® "30 Series"

| Part# | Connection | Length |
|----------------|---------------------|--------|
| 7304436 | 1/2" MIP x 1/2" MIP | 36" |
| 7304448 | 1/2" MIP x 1/2" MIP | 48" |
| 7304536 | 1/2" MIP x 1/2" FIP | 36" |
| 7304548 | 1/2" MIP x 1/2" FIP | 48" |
| 7304136 | 1/2" MIP x 3/4" MIP | 36" |
| 7304148 | 1/2" MIP x 3/4" MIP | 48" |
| 7305536 | 1/2" FIP x 1/2" FIP | 36" |
| 7305548 | 1/2" FIP x 1/2" FIP | 48" |
| 7305560 | 1/2" FIP x 1/2" FIP | 60" |
| 7301148 | 3/4" MIP x 3/4" MIP | 48" |
| 7301236 | 3/4" MIP x 3/4" FIP | 36" |
| 7302248 | 3/4" FIP x 3/4" FIP | 48" |

NEW FROM WATERLINE

GAS CONNECTOR HOSES - LARGE CAPACITY



- yellow coated
- for applications requiring increased flow, such as tankless hot water heaters, boilers and rooftop HVAC
- 1" OD (3/4" ID)
- corrugation extends all the way to the connection, which provides resistance to kinking
- for similar applications as Dormont® "40 Series"

| Part# | Connection | Length |
|-----------------|---------------------|--------|
| 74091024 | 3/4" MIP x 3/4" FIP | 24" |
| 74091036 | 3/4" MIP x 3/4" FIP | 36" |
| 74091048 | 3/4" MIP x 3/4" FIP | 48" |

NOUVEAU

ADD-A-STOP KITS FROM WATERLINE



- Enables new valve and hose to be added without having to remove the old jammed valve
- blister packaged
- Faucet kit includes two 12" braided faucet hoses, each of which is pre-crimped to a lead-free 3/8" OD Comp. x 3/8" FSV valve
- Toilet kit includes one 12" braided toilet hose pre-crimped to a 3/8" OD Comp. x 3/8" FSV valve

| Part# | Description |
|----------------|---------------------------|
| 1278050 | Add a stop for Faucet kit |
| 1278062 | Add a stop for toilet kit |

RUBBER ROOF VENT FLASHINGS



- 20" x 20" Base
- Made from strong SBR rubber
- For plastic, PVC and iron pipe

| Part# | Pitch | Description |
|---------------|---------------|---|
| 039011 | 2/12 to 8/12 | 1-1/2" Type B Rubber Roof Vent Flashing |
| 039021 | 2/12 to 8/12 | 2" Type B Rubber Roof Vent Flashing |
| 039031 | 2/12 to 12/12 | 3" Type B Rubber Roof Vent Flashing |
| 039041 | 2/12 to 8/12 | 4" Type B Rubber Roof Vent Flashing |

"HIGH DOME" ALUMINIUM ROOF VENT FLASHINGS



- for ABS DWV
- 20" x 20" base
- Elastomeric collar for vent stack
- expansion & contraction
- One piece and leakproof
- for 3" or 4" vent pipe

| Part# | Model | Vent Pipe Size |
|----------------|-------|----------------|
| 1771051 | A3PH | 3" |
| 1771061 | A4PH | 4" |

NEW FROM WATERLINE

ACCUCRIMP STAINLESS STEEL PEX CRIMPING SLEEVES



- a better way to crimp pex pipe connections - Accucrimp stainless steel sleeves
- easy to position the sleeve on the pipe perfectly every time
- obvious to naked eye whether or not a sleeve has been crimped
- a better finished look

| Part# | Description |
|----------------|---|
| 1970011 | Accucrimp SS Sleeves 1/2" Pex - Bag of 50 |
| 1970022 | Accucrimp SS Sleeves 3/4" Pex - Bag of 50 |
| 1970033 | Accucrimp SS Sleeves 1" Pex - Bag of 50 |

INSTALLATION TOOLS FOR ACCUCRIMP SLEEVES



- available in straight 1" and angle (1/2" and 3/4")

| Part# | Description |
|----------------|----------------------------------|
| 1599917 | 1" Straight SS Sleeve Crimp Tool |
| 1599905 | 1/2" Angle SS Sleeve Crimp Tool |
| 1599907 | 3/4" Angle SS Sleeve Crimp Tool |

COPPER FLEXIPOINT PUSHFIT MANIFOLDS



- Outlets includes valves
- the easiest manifolds to set up - all inlets and outlets with pushfittings (outlets include valves)
- comes with talon-style clips for hanging, disconnect tool, and a pushfitting for inlet and each outlet

| Part# | Ports | Inlet | Outlet | Style |
|----------------|-------|--------------|--------------|--------|
| 1374399 | 3 | 3/4" Pushfit | 1/2" Pushfit | Open |
| 1374499 | 4 | 3/4" Pushfit | 1/2" Pushfit | Open |
| 1375399 | 3 | 3/4" Pushfit | 1/2" Pushfit | Closed |
| 1375499 | 4 | 3/4" Pushfit | 1/2" Pushfit | Closed |

CLOSED COPPER PEX MANIFOLDS



- available in 3 - 12 ports
- 2" C-1 Type "L" copper trunk
- comes with talon-style clips for hanging
- all manifolds are closed, with 3/4" pex inlet and 1/2" pex branch outlets

| Part# | Ports |
|----------------|-------|
| 1411399 | 3 |
| 1411499 | 4 |
| 1411599 | 5 |
| 1411699 | 6 |
| 1411799 | 7 |
| 1411899 | 8 |
| 1411910 | 10 |
| 1411912 | 12 |

NEW FROM WATERLINE

FLEXITRAP™



- 1-1/2" rubber P-Trap
- connects in seconds with gear clamps
- able to accommodate misalignments of up to 2" between inlet and outlet

| Part# | Description |
|----------------|-------------|
| 1279001 | Flexitrap |

EQUALFLOW POLY ALLOY PEX MANIFOLDS



- made of tough poly-alloy plastic
- comes with special brackets for hanging
- cNSF certified to CSA B137.5 and complies with ASTM F2159
- available in closed, open or "H" pattern

| Part# | Ports | Inlet | Outlet | Style |
|----------------|-------|----------|----------|------------------|
| 2871499 | 4 | 3/4" Pex | 1/2" Pex | Closed |
| 2871699 | 6 | 3/4" Pex | 1/2" Pex | Closed |
| 2871668 | 6 | 1" Pex | 1/2" Pex | Closed |
| 2871899 | 8 | 3/4" Pex | 1/2" Pex | Closed |
| 2871668 | 8 | 1" Pex | 1/2" Pex | Closed |
| 2871599 | 5 | 3/4" Pex | 1/2" Pex | Open 1/2" Pex |
| 2871799 | 7 | 3/4" Pex | 1/2" Pex | Open 1/2" Pex |
| 2871999 | 9 | 3/4" Pex | 1/2" Pex | Open 1/2" Pex |
| 2873962 | 9 | 1" Pex | 1/2" Pex | Open 1/2" Pex |
| 2872399 | 3 | 3/4" Pex | 1/2" Pex | "H" Style Closed |
| 2872499 | 4 | 3/4" Pex | 1/2" Pex | "H" Style Closed |
| 2872699 | 6 | 3/4" Pex | 1/2" Pex | "H" Style Closed |

POWERAIR DUCT BOOSTERS



- these fan units install easily in existing ductwork, increasing airflow to rooms that are receiving insufficient heating or air-conditioning fans have a heavy-duty motor designed for years of operation can reduce utility bills and stop the hassle of continually adjusting the thermo stat or adding portable heaters
- can be used with forced air, oil, gas, and electric furnaces and heat pumps use the standard model for square, rectangular or round ductwork, unless one of the specialty models is required
- two specialty models are available - one for round or rectangular metal duct work 6" or larger; and one for use in 5" round metal or flexible ductwork for all units, an optional activator can be added that activates the booster based on air pressure in the duct - this unit is ready to wire to the furnace blower or wall switch

| Part# | Description |
|----------------|---|
| 1950103 | Standard Model |
| 1950104 | For round or rectangular metal duct work 6" or larger |
| 1950101 | For 5" round metal or flexible ductwork |
| 1950105 | Activator (optional) |

NOUVEAU

NEW FROM WATERLINE

METAL PEX BEND SUPPORT



- strong metal support bend for 1/2" pex pipe
- tightest turning radius
- with 2"x2" metal flange and 4 nail holes

| Part# | Description |
|---------|------------------------|
| 1502720 | Metal Pex Bend Support |

LEAD TO ABS WATER CLOSET CONNECTORS



- for lead toilet connections

| Part# | Size |
|---------|---------------|
| 1630011 | 4" x 3" x 8" |
| 1630021 | 4" x 3" x 12" |
| 1630031 | 3" x 4" x 6" |

SURLOK™ IRRIGATION CLAMPS AND CRIMPING TOOL



- SURLOK™ pinch clamps and crimping tool for fast and secure polyethylene pipe connections
- used on irrigation and water supply systems, for beverage supply lines, car wash supply lines and securing cables
- easy to use crimper, specially designed for irrigation clamps.

| Part# | Size |
|---------|-----------------------------|
| 1609210 | 1/2" clamps |
| 1609271 | 3/4" clamps |
| 1609331 | 1" clamps |
| 1601098 | Irrigation Pinch Clamp tool |

SECTION "A" COMMERCIAL INDEX

| | | | |
|---|------|--|------|
| Am/Std Urinal Hanger | A-18 | Faucet - Self Closing | A-12 |
| Am/Std Urinal Outlet Spud - Brass | A-16 | Faucet - Service Sink | A-3 |
| Am/Std Urinal Strainer | A-17 | Fillers - Glass Bar | A-13 |
| Blade Handle, Commercial Faucet | A-8 | Flange - Urinal PVC | A-17 |
| Brass Cast P-Traps | A-11 | Flush Tubes for Urinal | A-15 |
| Brass Urinal & Closet Spuds | A-16 | Flush Valve Parts - CAMBRIDGE BRASS | A-26 |
| Bubbler - Accessories | A-21 | Flush Valve Parts - CRANE | A-23 |
| Bubbler - Replacement Parts | A-21 | Flush Valve Parts - DELANY | A-25 |
| Bubbler Fountain 2-IN-1 Wrench | A-22 | Flush Valve Parts - SLOAN | A-24 |
| Bubbler Valve - Push Button | A-22 | Flush Valve Parts - TECK / CAMBRIDGE BRASS | A-26 |
| Bubbler with "Flex Flange" | A-19 | Flush Valve Parts - ZURN | A-25 |
| Bubblers - Drinking Fountain | A-19 | Fountains - Drinking - Push Button | A-20 |
| Bubblers, Retro Fit Kits | A-19 | Gaskets, Wall Hung Toilets | A-17 |
| CAMBRIDGE BRASS - Flush Valve Parts | A-26 | Glass Fillers | A-13 |
| Carrier Nuts & Washers for Urinal | A-19 | Gooseneck Faucet | A-4 |
| Cartridge - DELTA / CAMBRIDGE BRASS | A-27 | Gooseneck Spout, Commercial Faucets | A-8 |
| Cartridge - For SLOAN | A-25 | Handle - CRANE Urinal | A-23 |
| Cartridge - Pre-Rinse Spray | A-7 | Handle - SLOAN Urinal | A-24 |
| Cartridge for Bubbler | A-21 | Handles, Replacement Commercial Faucet | A-8 |
| Cartridges for Commercial Faucet | A-8 | Hangers for Urinals | A-18 |
| Cast Iron Traps. | A-10 | Head Pre-Rinse Spray | A-6 |
| Closet & Urinal Gaskets | A-17 | Hose - Pre-Rinse Faucet | A-6 |
| Closet Spuds - Brass | A-16 | Lavatory Faucet - Quarter Turn | A-13 |
| Commercial Faucet Deck Mount | A-2 | Lavatory Hanger, Iron | A-18 |
| Commercial Faucet Replacement Spouts | A-8 | Lever & Twist Sink Drain Parts | A-10 |
| Commercial Faucet, Gooseneck Wall mount | A-4 | Nuts, Spud for Urinal | A-15 |
| Commercial Faucet, Wall mount | A-1 | Outlet Spuds - Urinal | A-16 |
| Commercial Sink Drains | A-9 | Overflow Commercial | A-10 |
| Coupling Nuts For Flush Tubes | A-15 | Pantry Faucets | A-3 |
| CRANE - Flush Valve Parts | A-23 | Parts Replacement for Bubblers | A-21 |
| Crane Urinal Outlet Spud- Brass | A-16 | Parts for Lever & Twist Drains | A-10 |
| Crane Urinal Strainer | A-17 | Parts for Pre-Rinse Faucets | A-7 |
| DELANY - Flush Valve Parts | A-25 | Parts for T&S Brass, Handle | A-7 |
| DELTA / CAMBRIDGE BRASS Cartridge | A-27 | Parts, Cartridges, Commercial Faucets | A-8 |
| Deodorizing Block for Urinal | A-16 | Pre-Rinse Faucet Hose | A-6 |
| Diaphragm for CRANE | A-23 | Pre-Rinse Faucets | A-5 |
| Drains, Lever & Twist, Commercial | A-9 | Pre-Rinse - Add On Faucet | A-6 |
| Drinking Fountain - Self Closing | A-22 | Pre-Rinse - Spray Head | A-6 |
| Drinking Fountains Bubblers | A-19 | Pre-Rinse Replacement Parts | A-7 |
| Escutcheons Urinal | A-15 | P-Traps - Brass | A-11 |
| Exposed Shower, Commercial | A-11 | Push Button - Remote for Bubblers | A-22 |
| Faucet - Commercial Wall Mount | A-14 | Push Button Self Closing Faucets | A-14 |
| Faucet - Deck Mount 4" Centres | A-2 | PVC Urinal Flange | A-17 |
| Faucet - Deck Mount, Commercial | A-4 | Repair Kits, Flush Valves | A-23 |
| Faucet - Pantry | A-3 | Screens, Urinal | A-16 |
| Faucet - Pre-Rinse | A-5 | Self Closing Drinking Fountain | A-22 |
| Faucet - Pre-Rinse - Add On Faucet | A-8 | Self Closing Faucets | A-12 |
| Faucet - Push Button Self Closing | A-14 | Self Closing Push Button Valves | A-14 |
| Faucet - Quarter Turn Lavatory | A-13 | Self Closing Valves | A-12 |

FAUCET - COMMERCIAL

Institutional Quality - Specification Grade Contemporary Design - Individually Pressure Tested

FAUCET - WALL MOUNT - HEAVY DUTY - 8" CENTRES



- Chrome plated brass
- 1/2" FIP inlets
- Twin seal chrome plated brass tubular swing spout
- 55/64" female water saver aerator
- Colour coded handles
- Adjusts 7-1/2" to 8-1/2"
- Full flow with a quarter turn of the handle
- Replacement handles & cartridges available (**see page A-8**)
- For adjustable coupling see **part#33352** below
- cUPC approved

| PART# | DESCRIPTION |
|--------------|--|
| 33006 | 6" spout length, adjusts 7-1/2" to 8-1/2" |
| 33008 | 8" spout length, adjusts 7-1/2" to 8-1/2" |
| 33010 | 10" spout length, adjusts 7-1/2" to 8-1/2" |
| 33012 | 12" spout length, adjusts 7-1/2" to 8-1/2" |
| 33014 | 14" spout length, adjusts 7-1/2" to 8-1/2" |
| 33027 | Cold cartridge |
| 33028 | Hot cartridge |

FAUCET - WALL MOUNT - MEDIUM DUTY - 8" CENTRES



- Chrome plated brass
- 1/2" FIP inlets
- Twin seal chrome plated brass tubular swing spout
- 55/64" female water saver aerator
- Colour coded handles
- Adjusts 7-1/2" to 8-1/2"
- Replacement handles & cartridges available (**see page A-8**)
- For adjustable coupling see **part#33352** below
- cUPC approved

| PART# | DESCRIPTION |
|--------------|--|
| 33308 | 8" spout length, adjusts 7-1/2" to 8-1/2" |
| 33310 | 10" spout length, adjusts 7-1/2" to 8-1/2" |
| 33312 | 12" spout length, adjusts 7-1/2" to 8-1/2" |
| 33314 | 14" spout length, adjusts 7-1/2" to 8-1/2" |
| 33020 | Cold cartridge |
| 33021 | Hot cartridge |

COUPLING - FEMALE SUPPLY INLET



part#33352

part#33350

- Chrome plated brass
- 1/2" FIP inlets
- **Part#33350 and part#33352** fit heavy duty wall mount faucets
- **Part#33351** fits moderate duty wall mount faucets

| PART# | FITS | ADJUSTS |
|--------------|-------------|------------------------------|
| 33350 | Heavy duty | 7-1/2" to 8-1/2" |
| 33351 | Medium duty | 7-1/2" to 8-1/2" |
| 33352 | Heavy duty | 4-1/2" to 12-1/2" with stops |

FAUCET - COMMERCIAL DECK MOUNT

FAUCET - DECK MOUNT - HEAVY DUTY - 4" CENTRES



- Chrome plated brass
- 1/2" FIP inlets
- Satin finished brass water ways
- 55/64" female water saver aerator
- Twin seal chrome plated brass tubular swing spout
- Replacement handles & cartridges available (see page A-8)

| PART# | DESCRIPTION |
|-------|------------------|
| 33105 | 6" spout length |
| 33106 | 12" spout length |

MEDIUM DUTY DECK MOUNT FAUCET - 4" CENTRES



- Same features as above model but a lighter pattern style and plain brass water ways

| PART# | DESCRIPTION | APPROVAL |
|-------|---------------------------|----------|
| 33151 | 6" gooseneck spout length | cUPC |
| 33152 | 6" spout length | cUPC |
| 33153 | 8" spout length | cUPC |
| 33154 | 10" spout length | cUPC |
| 33155 | 12" spout length | cUPC |
| 33156 | 14" spout length | cUPC |
| 33160 | Replacement handles | - |
| 33322 | Cold cartridge | - |
| 33323 | Hot cartridge | - |

MEDIUM DUTY WALL MOUNT FAUCET - 4" CENTRES



- Same features as above models but a lighter pattern style and plain brass water ways

| PART# | DESCRIPTION | APPROVAL |
|-------|---------------------------|----------|
| 33161 | 6" gooseneck spout length | cUPC |
| 33162 | 6" spout length | cUPC |
| 33163 | 8" spout length | cUPC |
| 33164 | 10" spout length | cUPC |
| 33165 | 12" spout length | cUPC |
| 33166 | 14" spout length | cUPC |
| 33160 | Replacement handles | - |
| 33322 | Cold cartridge | - |
| 33323 | Hot cartridge | - |

FAUCET - SPECIAL DUTY COMMERCIAL

SERVICE SINK FAUCET - 8" CENTRES & 8" SPOUT



- Built in screwdriver stops
- Integral check stems
- 1/2" FIP inlets
- Rough chrome plated brass
- 3/4" male hose thread on spout
- Chrome plated brass hinged wall support
- 7-1/2" to 8-1/2" wall centres
- 12" wall bracket
- cUPC approved



| PART# | DESCRIPTION |
|--------------|-----------------|
| 33110 | 1/2" FIP inlets |
| 33027 | Cold cartridge |
| 33028 | Hot cartridge |

SERVICE SINK FAUCET - 8" CENTRES & 2-1/2" SPOUT



- Built in screwdriver stops
- Integral check stems
- 1/2" FIP inlets
- Rough chrome plated brass
- 3/4" male hose thread on spout
- 7-1/2" to 8-1/2" wall centres
- 12" wall bracket
- cUPC approved



| PART# | DESCRIPTION |
|--------------|-----------------|
| 33109 | 1/2" FIP inlets |
| 33027 | Cold cartridge |
| 33028 | Hot cartridge |

FAUCET - DECK MOUNT PANTRY

Dual Or Single Handle



part#33111



part#33113



part#33115



part#33117

- 1/2" FIP inlets
- Chrome plated brass
- 1/4" tailpieces on dual handle model
- Cold handle only on single lever, 1/2" FIP inlet
- 55"/64" female water saver aerator

| PART# | DESCRIPTION |
|--------------|-------------|
| 33111 | Hot & cold |
| 33113 | Cold only |
| 33115 | Hot & cold |
| 33117 | Cold only |

FAUCET - SPECIAL DUTY COMMERCIAL

FAUCET - WALL MOUNT - 8" CENTRES



- Comes with blade style handles
- With 10" swing gooseneck spout
- 1/2" FIP inlets
- Chrome plated brass
- 55"/64" female water saver aerator
- Twin seal chrome plated brass tubular swing gooseneck spout

| PART# | DESCRIPTION |
|--------------|------------------------------|
| 33190 | 7-1/2" to 8-1/2" |
| 33194 | 4-1/2" to 12-1/2" with stops |
| 33027 | Cold cartridge |
| 33028 | Hot cartridge |

HEAVY DUTY DECK MOUNT FAUCET - 4" CENTRES



- 1/2" FIP inlets
- Chrome plated brass
- 55"/64" female water saver aerator
- Twin seal chrome plated brass tubular swing spout

| PART# | DESCRIPTION |
|--------------|------------------|
| 33107 | 6" spout length |
| 33108 | 12" spout length |
| 33027 | Cold cartridge |
| 33028 | Hot cartridge |

PRE-RINSE ASSEMBLIES - COMMERCIAL

Chrome Plated Brass - Built For Rugged Use.

PRE-RINSE - WALL MOUNT 8" CENTRES



Riser shortened for photo

- Available with either standard 7-1/2" to 8-1/2" adjustable female supply inlet couplings, or with 4-1/2" to 12-1/2" female supply inlet couplings with stops
- 1/2" FIP inlets
- 3/8" IPS x 24" chrome plated brass riser
- 44" stainless steel hose
- 12" wall bracket
- Food service grade

| PART# | DESCRIPTION |
|-------|-----------------------|
| 33013 | Wall mount 8" centres |

PRE-RINSE - DECK MOUNT - SINGLE HANDLE



Riser shortened for photo

- Chrome plated brass
- Built for rugged use
- Fits decks up to 1-1/4" thick
- 1/2" IPS inlet with 1/4" IPS tailpiece nipple
- 3/8" IPS x 24" chrome plated brass riser
- 44" stainless steel hose
- 12" wall bracket
- Food service grade

| PART# | DESCRIPTION |
|-------|---------------|
| 33100 | Single handle |

PRE-RINSE - DECK MOUNT



Riser shortened for photo

- Fits decks up to 1-1/4" thick
- 1/2" MIP inlets
- 1/4" IPS tailpiece nipples
- 3/8" IPS x 24" chrome plated brass riser
- 44" stainless steel hose
- 12" wall bracket
- Food service grade
- Single hole mount

| PART# | DESCRIPTION |
|-------|----------------------|
| 33612 | Pre-rinse deck mount |

PRE-RINSE - DECK MOUNT - 8" CENTRES



Riser shortened for photo

- 1/2" FIP inlets
- 3/8" IPS x 24" chrome plated brass riser
- 44" stainless steel hose
- 12" wall bracket
- Food service grade
- Chrome plated brass

| PART# | DESCRIPTION |
|-------|-----------------|
| 33003 | 1/2" FIP inlets |

PRE - RINSE SPRAY ASSEMBLY - PARTS

PRE-RINSE - ADD ON FAUCET



- Connects to 3/8" pre-rinse riser
- Chrome plated brass
- 3/8" x 2-3/4" MIP inlet
- Spout with aerator
- With hot or cold colour codes
- Fits all manufacturers

| PART# | DESCRIPTION |
|-------|----------------|
| 33614 | 6" long spout |
| 33615 | 12" long spout |

HOSE - PRE-RINSE



- Flexible stainless steel
- Food grade inner hose withstands continuous working temperature

| PART# | DESCRIPTION |
|-------|-------------|
| 33044 | 44" long |
| 33060 | 60" long |
| 33072 | 72" long |

PRE-RINSE - SPRAY



REPLACES T & S

- Chrome plated brass
- High impact plastic handle
- Connects directly to hose
- High pressure wash
- Positive shut off
- Stay ring included
- For replacement cartridge please see **page A-7**

| PART# | DESCRIPTION |
|-------|--|
| 33018 | Complete |
| 33020 | Bumper ring |
| 33021 | Spray face |
| 33030 | Replacement shaft with male x female IPS |

PRE - RINSE SPRAY ASSEMBLY - PARTS

CARTRIDGE - PRE-RINSE SPRAY



- Chrome plated brass
- Replacement cartridge for **part#33018 (page A-6)** pre-rinse spray
- Also fits T&S BRASS models

| PART# | DESCRIPTION |
|--------------|---------------------|
| 33019 | Chrome plated brass |

PRE-RINSE PARTS

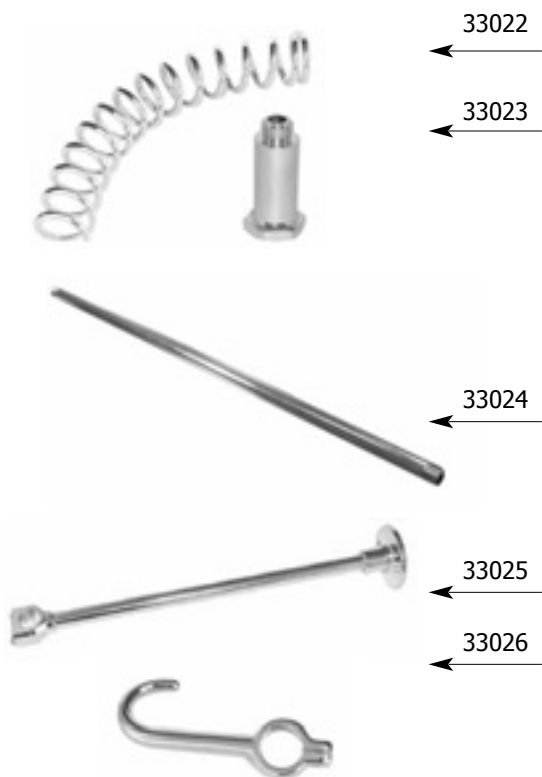

- 1-1/2" L SPRING**
 - Shortened for photo
 - Chrome

- COUPLING FOR SPRING**
 - 3/8" x 3/8" x 3" long

- RISER NIPPLE**
 - 3/8" x 24"

- WALL BRACKET FOR RISER**
 - C.P. brass
 - 12" long

- RISERHOOK**
 - C.P. brass

| PART# | DESCRIPTION |
|--------------|----------------------------------|
| 33022 | L-Spring 1-1/2" diameter |
| 33023 | Spring coupling |
| 33024 | 3/8" x 24" C.P. riser nipple |
| 33025 | 12" wall bracket fits 3/8" riser |
| 33026 | 3/8" riser hook |

REBUILD HANDLE FOR T&S BRASS



- Rebuild ETERNA handle assembly
- Also will fit others including LynCar models
- OEM ref#02713-40

| PART# | DESCRIPTION |
|--------------|------------------------------|
| 33325 | Rebuild handle for T&S BRASS |

COMMERCIAL FAUCET REPLACEMENT PARTS

SWING SPOUT



- Twin seal
- Tubular
- Chrome plated brass
- 55/64" female water saver aerator

STEM - REPLACEMENT



- For heavy duty style faucets

PART# DESCRIPTION

| | |
|--------------|-------------|
| 33806 | Spout - 6" |
| 33808 | Spout - 8" |
| 33810 | Spout - 10" |
| 33812 | Spout - 12" |
| 33814 | Spout - 14" |
| 33816 | Spout - 16" |
| 33818 | Spout - 18" |

PART# DESCRIPTION

| | |
|--------------|---------------------------------|
| 33027 | Heavy duty - Cold |
| 33028 | Heavy duty - Hot |
| 33031 | Heavy duty - Seat 5/8" x 27 TPI |

SPOUT - GOOSENECK - HEAVY DUTY



- Twin seal
- Tubular chrome plated brass
- 55/64" female water saver aerator

STEM - REPLACEMENT



- For medium duty style faucets

PART# DESCRIPTION

| | |
|--------------|-----------------------|
| 33831 | Gooseneck spout - 6" |
| 33832 | Gooseneck spout - 9" |
| 33833 | Gooseneck spout - 12" |

PART# DESCRIPTION

| | |
|--------------|-------------------------|
| 33320 | 8" centre faucet - Cold |
| 33321 | 8" centre faucet - Hot |
| 33322 | 4" centre faucet - Cold |
| 33323 | 4" centre faucet - Hot |

SPOUTS - DOUBLE SWING



- Twin seal
- Tubular
- Chrome plated brass
- 55/64" female water saver aerator

HANDLE - REPLACEMENT



- Hot / cold pair
- 20 spline

PART# DESCRIPTION

| | |
|--------------|-------------|
| 33850 | Spout - 18" |
|--------------|-------------|

PART# DESCRIPTION

| | |
|--------------|-------------------------|
| 33029 | HD - hot / cold - lever |
|--------------|-------------------------|

FAUCET - WALL MOUNT HEAVY DUTY SINGLE HANDLE



- Swing style
- Pot filler
- Cold water only
- Chrome plated brass
- Twin seal tubular spout
- 18" overall length

HANDLE - BLADE STYLE



- Hot / cold pair
- 20 spline

PART# DESCRIPTION

| | |
|--------------|-----------------------------|
| 33112 | 1/2" MPT inlet, spout - 18" |
|--------------|-----------------------------|

PART# SIZE

| | |
|--------------|---------------|
| 33104 | 4" hot / cold |
| 33103 | 6" hot / cold |

LEVER AND TWIST COMMERCIAL SINK DRAIN

DRAIN - LEVER HANDLE WITHOUT OVERFLOW



- Sink opening: 3-1/2"
- Utilize a 4-1/2" strainer flange
- Nickel plated brass body
- Stainless steel handle
- Stainless steel strainer
- Nickel plated brass stopper
- Replaces FRANKLIN, KLEIN, CHICAGO FAUCET, T&S BRASS

| PART# | DESCRIPTION |
|--------------|-------------------------|
| 33122 | 1-1/2" drain connection |
| 33123 | 2" drain connection |

DRAIN - LEVER HANDLE W/ 1-1/4" OVERFLOW OUTLET



- Sink opening: 3-1/2"
- Utilize a 4-1/2" strainer flange
- Nickel plated brass body
- Stainless steel handle
- Stainless steel strainer
- Nickel plated brass stopper
- Replaces FRANKLIN, KLEIN, CHICAGO FAUCET, T&S BRASS

| PART# | DESCRIPTION |
|--------------|-------------------------|
| 33131 | 1-1/2" drain connection |
| 33125 | 2" drain connection |

DRAIN - TWIST LEVER HANDLE WITHOUT OVERFLOW



- Sink opening: 3-1/2"
- Utilize a 4-1/2" strainer flange
- Nickel plated brass body
- Stainless steel handle
- Stainless steel strainer
- Nickel plated brass stopper
- Replaces FRANKLIN, KLEIN, CHICAGO FAUCET, T&S BRASS

| PART# | DESCRIPTION |
|--------------|-------------------------|
| 33126 | 1-1/2" drain connection |
| 33127 | 2" drain connection |

DRAIN - TWIST LEVER HANDLE W/ 1-1/4" OVERFLOW OUTLET



- Sink opening: 3-1/2"
- Utilize a 4-1/2" strainer flange
- Nickel plated brass body
- Stainless steel handle
- Stainless steel strainer
- Nickel plated brass stopper
- Replaces FRANKLIN, KLEIN, CHICAGO FAUCET, T&S BRASS

| PART# | DESCRIPTION |
|--------------|-------------------------|
| 33145 | 1-1/2" drain connection |
| 33146 | 2" drain connection |

PARTS FOR LEVER AND TWIST DRAINS

LEVER AND TWIST DRAIN PARTS

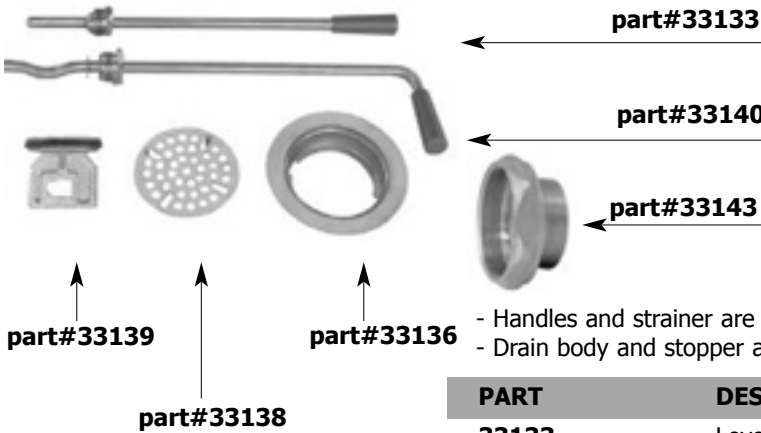

- Handles and strainer are stainless steel
- Drain body and stopper are nickel plated brass

| PART | DESCRIPTION |
|-------|--|
| 33133 | Lever handle |
| 33136 | 3-1/2" strainer flange |
| 33138 | 3-1/2" strainer |
| 33139 | Stopper with o-ring |
| 33140 | Twist handle |
| 33143 | 2" x 1-1/2" slip joint drain reducer bushing |
| 33150 | Lever drain washer repair kit (not pictured) |

TRAP - CAST IRON STANDARD ADJUSTABLE



- Enamel white finish
- Chrome plated brass strainer
- Fits AMERICAN STANDARD, CRANE, ELJER, KOHLER, and other cast iron service sinks

| PART# | DESCRIPTION |
|-------|-------------|
| 60003 | 3" IPS |

SINK OVERFLOW - COMMERCIAL

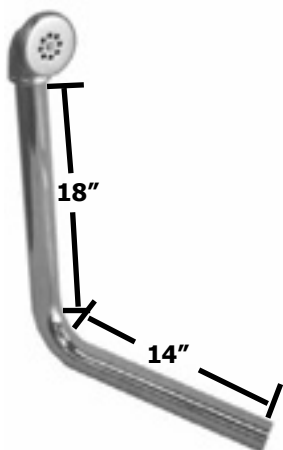

- Chrome plated brass
- 1-1/4" x 14" x 18" tube
- 1-1/4" satin chrome plated elbow
- Stainless steel overflow strainer & screw

| PART# | DESCRIPTION |
|-------|---|
| 33141 | Strainer with 1-1/4" elbow |
| 33142 | 1-1/4" x 14" x 18" brass overflow elbow for slip joint connection |
| 33144 | Strainer only |
| 33147 | Complete unit as shown |

PARTS FOR LEVER AND TWIST DRAINS

P-TRAPS - BRASS



part#34310
part#34315

part#34300
part#34305

- LYNCAR'S p-traps in cast brass
- Available in 1-1/2" or 2" sweat connections
- With or without cleanout

| PART# | DESCRIPTION |
|--------------|--|
| 34300 | Brass trap with cleanout 1-1/2" |
| 34305 | Brass trap with cleanout 2" |
| 34310 | Brass trap less cleanout 1-1/2" |
| 34315 | Brass trap less cleanout 2" |

SINK STAND PIPES

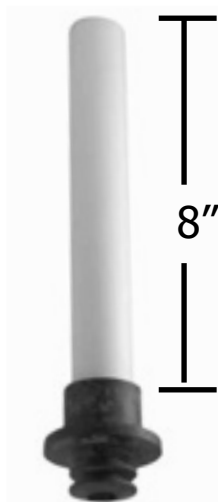

part# 33622
Drain Assembly



part#33623



part#33624

- For bars, restaurants and laboratories
- Easy to install!
- Simply insert into drain and walk away!
- Chemical resistant
- Plastic tube is easy to adjust, simply cut with ordinary tools
- Standard chemical resistant poly-stainless
- A co-polymer alloy for stainless steel sinks, bars, and restaurants
- High chemical resistant model for laboratories is available, please call

| PART# | DESCRIPTION |
|--------------|--------------------------------------|
| 33620 | 1" stand pipe assembly |
| 33621 | 1-1/2" stand pipe assembly |
| 33622 | 1" poly stainless drain assembly |
| 33623 | 1-1/2" poly stainless drain assembly |
| 33624 | Nut adapter 1-1/2 x 1" |

COMMERCIAL EXPOSED SHOWER



- Economical, yet ruggedly constructed for outdoor installations
- Deck - patio - pool
- Wall mount
- Chrome plated brass
- 7" to 9-1/2" wall adjustment
- Adjustable low flow showerhead
- 6" adjustable wall bracket
- Cross handles
- 24" riser
- 1/2" IPS female inlets

| PART# | DESCRIPTION |
|--------------|------------------------------|
| 67252 | 7" to 9-1/2" wall adjustment |

SELF CLOSING VALVES

VALVE - SELF CLOSING SHOWER



- Chrome plated brass
- 10" pull chain
- Connect from water supply to showerhead
- Indoor or outdoor use
- Approximately 2-1/2" x 3-3/4"
- cUPC approved

VALVE - SELF CLOSING STOP



- Chrome plated brass
- Cross handle
- Spring loaded for fast close
- Use on: outdoor showers, foot washing stations and urinals
- cUPC approved

| PART# | DESCRIPTION |
|-------------|---------------------------|
| 2193 | 1/2" FIP inlet and outlet |

| PART# | DESCRIPTION |
|-------------|---------------------|
| 2192 | 1/2" FIP x 1/2" FIP |

FAUCET - SELF CLOSING



- Chrome plated brass
- 1/2" IPS shank
- Low flow aerator
- Complete with locknut and rosette
- cUPC approved

SELF - CLOSING LAVATORY FAUCETS HEAVY DUTY



- Lever handle
- Low flow aerator
- Vandal resistant cap
- Chrome plated brass
- 1/2" IPS shank
- Complete with locknut and rosette

| PART# | DESCRIPTION |
|-------------|---------------------|
| 2191 | Faucet self closing |

| PART# | DESCRIPTION |
|--------------|---------------------------|
| 21932 | Heavy duty / self closing |

COMMERCIAL FAUCETS AND DRAINS

SELF - CLOSING WALL FAUCETS - HEAVY DUTY



- Lever handle
- Vandal resistant cap
- No aerator
- Chrome plated brass

| PART# | DESCRIPTION |
|--------------|----------------|
| 21937 | 1/2" FIP inlet |

FAUCET - QUARTER TURN LAVATORY



- Chrome plated brass
- Low flow aerator
- Hot or cold cross handle
- 1/2" IPS shank
- Complete with locknut and rosette
- Not self closing

| PART# | DESCRIPTION |
|--------------|-------------|
| 21805 | Hot handle |
| 21806 | Cold handle |

GLASS FILLER - WALL MOUNT

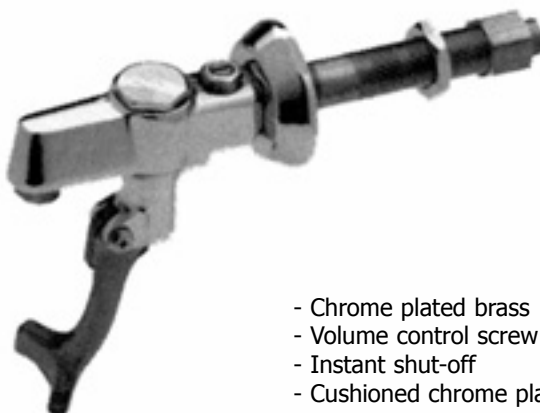

- Chrome plated brass
- Volume control screw
- Instant shut-off
- Cushioned chrome plated brass push arm

part#12003 With flange 3-3/4"
centre of spout to wall

| PART# | DESCRIPTION |
|--------------|------------------------------|
| 12003 | 3/8" IPS female inlet |
| 12020 | 3/8" x 2-1/4" IPS male inlet |

PUSH BUTTON FAUCET

FAUCET - PUSH BUTTON SELF CLOSING



- Chrome plated brass
- Low flow aerator
- Complete with locknut and rosette
- Non-adjustable slow close
- Closes in approximately 6 seconds at 60 PSI
- Economical

VALVE - PUSH BUTTON SELF CLOSING 90°



- 1/2" FIP inlet and outlet valve only, no nipples
- PLEASE NOTE:
- Use either **part#993** flush tube or **part#984** nut and fine thread flush tube to adapt the above valves into flush valves

PART# DESCRIPTION

21803 1/2" IPS shank

PART# DESCRIPTION

21810 Chrome plated brass

FAUCET - PUSH BUTTON SELF CLOSING LAVATORY



- PLUMBERS QUALITY
- Chrome plated brass
- Low flow aerator
- 1/2" IPS shank
- Complete with locknut and rosette
- With regulated slow close timing screw

VALVE - PUSH BUTTON SELF CLOSING 180°



- Chrome plated brass
 - 0-20 second adjustment 2.75 GPM
- PLEASE NOTE:
- Use either **part#993** flush tube or **part#984** nut and fine thread flush tube to adapt the above valves into flush valves

PART# DESCRIPTION

21800 Plumbers quality

PART# DESCRIPTION

21830 1/2" FIP inlet and outlet valve ONLY, no nipples

URINAL PARTS

URINAL LARGE - STRAINERS CAULK TO 2" DWV



- For wall to floor urinals
- Flat or beehive
- Stainless steel strainer
- Brass body
- Strainer screw holes on 3-5/16" centres
- 4-3/8" across flange

| PART# | DESCRIPTION |
|-------|---------------------------|
| 970 | Flat strainer complete |
| 971 | Beehive strainer complete |
| 972 | Flat grill with screws |
| 973 | Beehive grill with screws |

URINAL - FLUSH TUBES



- 3/4" OD CP brass

| PART# | DESCRIPTION |
|-------|------------------------------------|
| 986 | 6-1/2" long, fine thread - one end |
| 989 | 15" long, fine thread - one end |
| 993 | 6-1/2" long, 1/2" MPT - one end |
| 997 | 8" long, NO threads - both ends |

URINAL - COUPLING NUT FOR FLUSH TUBES



- Chrome plated brass

| PART# | DESCRIPTION |
|-------|-----------------------------|
| 984 | 3/4" fine thread x 1/2" MPT |

URINAL - SPUD NUT & ESCUTCHEON



| PART# | DESCRIPTION |
|-------|-------------------------------|
| 980 | 3/4" IPS spud nut & washer |
| 981 | Escutcheon |
| 982 | Spud nut, escutcheon & washer |

URINAL PARTS

URINAL - OUTLET SPUD - BRASS



- With bolts, washers and nuts and **part#2096 (page C-2)** sponge type gasket
- IPS or sweat connection

| PART# | DRAIN CONNECTION | URINAL TYPE | BOLT HOLE CENTERS |
|--------------|------------------|-------------|-------------------|
| 94700 | 2" IPS | CRANE | 5-1/2" |
| 94701 | 2" Sweat | CRANE | 5-1/2" |
| 94705 | 2" Sweat | AM/STD | 4" |
| 94706 | 2" IPS | AM/STD | 4" |
| 94707 | 2" Sweat | ELJER | 4-1/4" |

URINAL - AND CLOSET SPUDS



| PART# | TYPE | SIZE | LOCKNUT | WASHER |
|------------|--------|-----------------|---------|------------------|
| 956 | Closet | 2" | Brass | part#2085 |
| 957 | Closet | 2" x 1-1/2" | Brass | part#2086 |
| 958 | Closet | 2" x 1-1/4" | Brass | part#2087 |
| 959 | Closet | 1-1/2" | Brass | part#2088 |
| 960 | Closet | 1-1/4" | Brass | part#2089 |
| 961 | Urinal | 1" x 3/4" | Brass | part#2090 |
| 962 | Urinal | 1-1/4" x 3/4" | Brass | part#2089 |
| 963 | Closet | 1-1/2" x 1-1/4" | Brass | part#2088 |

URINAL SCREEN, SCENTED

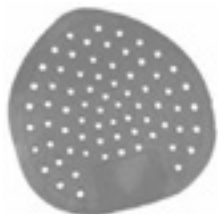

- Universal shape
- Economical order control
- Length 19 cm / 7-1/2"
- Red, with cherry scent

| PART# | DESCRIPTION |
|------------|------------------------|
| 966 | Urinal screen, scented |

URINAL SCREEN WITH DEODORIZING BLOCK



- A disposable vinyl urinal screen which prevents foreign objects like chewing gum, matches and cigarette butts from being flushed down the urinal drain.
- The deodorizing block releases a pleasant fragrance with each flush and also releases a caustic which attacks clogging urinal salts.

| PART# | DESCRIPTION |
|------------|--------------------------------------|
| 967 | Urinal screen with deodorizing block |

DEODORIZING BLOCK



- The deodorizing block releases a pleasant fragrance with each flush and also releases a caustic which attacks clogging urinal salts.

| PART# | DESCRIPTION |
|------------|--------------------------|
| 965 | Urinal deodorizing block |

URINAL PARTS

URINAL STRAINER



- Top quality stainless steel with mounting hardware
- Photo shown is **part#969**

| PART# | DESCRIPTION |
|------------|-------------------|
| 969 | AMERICAN STANDARD |
| 968 | CRANE |

URINAL FLANGE KIT PVC 2" ADJUSTABLE



- PVC plastic
- Complete with gasket
- Hub / inside / spigot versions

| PART# | DESCRIPTION |
|------------|-------------------------|
| 975 | Adjustable hub flange |
| 976 | Adjustable inside fit |
| 977 | Adjustable spigot style |

WALL HUNG CLOSET AND URINAL GASKET KIT



- Works with all manufacturers
- Kit includes:
 - Chemical resistant sponge gasket
 - Alignment ring
 - Adhesive tape
 - OD 3-1/2"

| PART# | DESCRIPTION |
|-------------|---------------|
| 2062 | Closet gasket |
| 2064 | Urinal gasket |

WALL HUNG TOILET STABILIZER SEAL GASKET

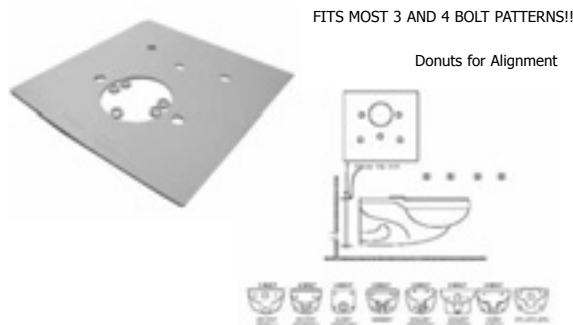

- TP rubber construction creates a total seal
- Self forming material eliminates wobbles and rocking
- Trim with ordinary razor blade knife
- Greatly reduces risk of cracked bowls
- Protects the wall & ceilings below from water damage
- Protects against cracked mounting
- Available in standard white
- Custom colours upon request

Works with toilets – 1.6 GPF thru 4.5 GPF

| PART# | DESCRIPTION |
|-------------|------------------|
| 1009 | Wall hung toilet |

HANGERS

LAVATORY HANGER, IRON



- 10-1/2" wide
- Extra heavy cast iron

| PART# | DESCRIPTION |
|-------|----------------------|
| 1219 | Lavatory hanger, 10" |

URINAL / LAVATORY HANGER



- Stamped steel

| PART# | DESCRIPTION |
|-------|-----------------|
| 1220 | Lavatory hanger |

Z - HANGER, IRON



- Adjustable for enameled iron or china lavatories
- For iron, side lugs fit the pockets
- For china, knock off the side lugs 5" to 16" adjustment
- Cast iron

| PART# | DESCRIPTION |
|-------|------------------------|
| 1221 | Z - Hanger, adjustable |

LAVATORY HANGER, STEEL

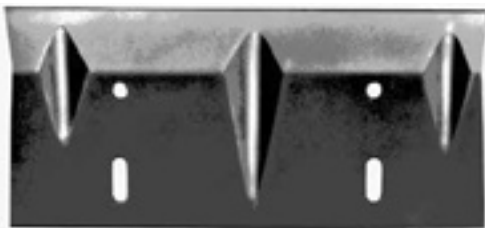

- For china lavatories
- Stamped steel
- Plated for corrosion resistance
- 8" wide

| PART# | DESCRIPTION |
|-------|---------------------------|
| 1222 | Lavatory hanger, 8" steel |

LAVATORY HANGER - AMERICAN STANDARD STYLE , STEEL

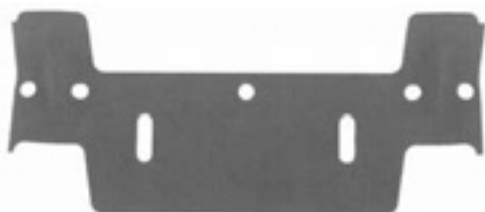

- Designed to fit AMERICAN STANDARD style lavatories
- Stamped steel
- Plated for corrosion resistance
- 10-1/2" wide

| PART# | DESCRIPTION |
|-------|---|
| 1223 | Lavatory hanger - AMERICAN STANDARD style |

CARRIER NUTS AND DRINKING FOUNTAIN

CARRIER NUTS & WASHERS

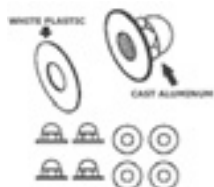

STANDARD



EXTENDED

- For wall hung toilets and urinals
- Four sets of hardware per bag

| PART# | DESCRIPTION |
|--------------|---------------------|
| 33128 | Standard, 4 per bag |
| 33217 | Extended, 4 per bag |

RETRO FIT KIT WITH SAFETY FLANGE FOR BUBBLER



- Brass body bubbler with "flex- flange"
- Stainless steel cartridge
- Retro kit consists of: 1/2" x 3/8" x 3-1/2" nipple
- Stainless steel flange, rosette, locknut, coupling nut and 1-3/4" cockhole cover

| PART# | DESCRIPTION |
|-------------|--|
| 2199 | Retro fit kit with safety flange bubbler |

DRINKING FOUNTAIN CONVERSION KIT



- Our Retrofit Kit **part#2197 (page A-20)** added with **part#5550 (page F-1)** 12" supply line 1/2" IPS x 3/8 OD compression , **part#3329 (page F-8)** quarter turn valve
- Converts a twist handle fountain to a push button unit
- Easy to install

| PART# | DESCRIPTION |
|---------------|----------------|
| 2197AS | Conversion kit |

DRINKING FOUNTAINS

DRINKING FOUNTAIN - RETRO - FIT KIT PUSH BUTTON



KIT CONTAINS:

- **Part#2194** chrome plated brass bubbler head with stainless steel cartridge
- 1/2" x 3/8" x 3-1/2" nipple brass
- Polished stainless steel flange
- Rosette, locknut & coupling nut
- 1-3/4" cockhole cover

PART# DESCRIPTION

2197 Retro-Fit Kit

BUBBLER WITH "FLEX FLANGE"

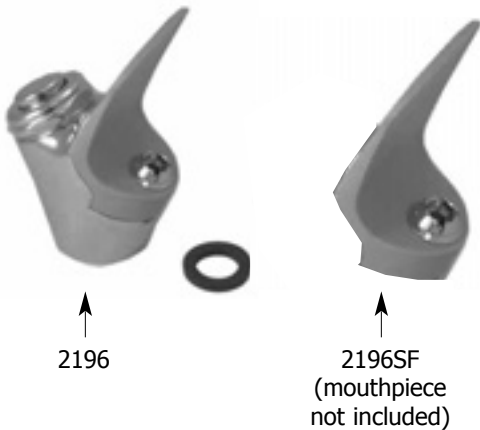

- Stainless steel cartridge
- LYNCAR bubbler with rubber "flex" flange to protect teeth and mouth
- Grey rubber front
- Easy to replace when required

PART# DESCRIPTION

2196 Bubbler - with "Flex" flange

2196SF Rubber replacement - plastic safety front flange

2198 Retrofit unit - accessory package for bubbler

DRINKING FOUNTAIN - PUSH BUTTON



- 3/8" FIP
- Chrome plated brass
- Stainless steel cartridge
- Replaces HAWS HW5010

PART# DESCRIPTION

2194 Drinking fountain bubbler with lead free cartridge

BUBBLER PARTS

ACCESSORY PACKAGE FOR BUBBLER



- Parts only to change old style bubbler to push button
- Includes:
 - 1/2" x 3/8" x 3-1/2" brass nipple
 - Stainless steel flange
 - Cockhole cover 1-3/4"
 - Rosette, locknut & coupling nut

| PART# | DESCRIPTION |
|-------|-------------------------------|
| 2198 | Accessory package for bubbler |

REPLACEMENT CARTRIDGE FOR BUBBLER



- Stainless steel replacement cartridge
- Fits **part#2197**, **part#2196**, and **part#2194**

| PART# | DESCRIPTION |
|-------|------------------------|
| 2195 | Replacement cartridges |

REPLACEMENT BUBBLER PARTS



part#2194-1



part#2194-2



part#2194-3



part#2194M

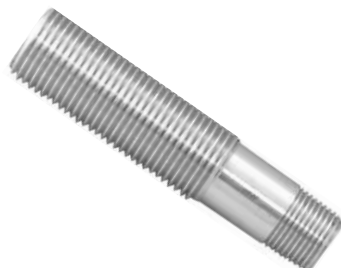

part#2187
part#2188

| PART# | DESCRIPTION |
|--------|--|
| 2194-1 | Chrome collar for button |
| 2194-2 | Chrome push button |
| 2194-3 | Cartridge retention bushing |
| 2194-6 | Inlet washer |
| 2194M | Mouthpiece set for part#2194 |
| 2196F | Rubber flange replacement for part#2196 |
| 2196M | Mouthpiece set for part#2196 |
| 2187 | Nipple 1/2 x 3/8 x 3-1/2 |
| 2188 | Long nipple 1/2 x 3/8 x 4-1/2 |

BUBBLER PARTS

VALVE - REMOTE PUSH BUTTON



- Superior quality
- Chrome plated brass button and escutcheon
- 1/4" FIP
- Lead-free cartridge

| PART# | DESCRIPTION |
|-------|--------------------|
| 2179 | Remote push button |

FOUNTAIN 2-IN-1 WRENCH



- Tightens or loosens cartridge retaining bushing
- Prevents bushing thread damage which causes leaks

| PART# | DESCRIPTION |
|-------|------------------------|
| 7047 | Fountain 2-in-1 wrench |

DRINKING FOUNTAIN - SELF CLOSING



- 1/2" FIP
- Chrome plated brass
- Flow regulator screw
- Cross handle
- Precision ball bearing action

| PART# | DESCRIPTION | APPROVAL |
|---------|--|----------|
| 2190 | Drinking fountain, FIP 1/2" connection | cJPC |
| 2190-05 | Handle cap nut | |
| 2190-13 | Regulator screw cap nut | |
| 2190RK | Repair kit | |

FLUSH VALVE PARTS FOR CRANE

CRANE FLUSH VALVE HANDLE



- Flush handles
- With stem and nut
- Chrome brass fittings

| PART# | DESCRIPTION |
|--------------|--|
| 32900 | CRANE flush valve handle, stem size 1-15/16", blue tip, for FLUSHBOY & REX |
| 32907 | PRESTO/ EMPIRE / REX non hold open, stem size 1-9/16", white tip |
| 32908 | PRESTO / EMPIRE, stem size 1-11/16", blue tip |

CRANE STEM & VALVES



- Operating stems and relief valves

| PART# | DESCRIPTION |
|--------------|--|
| 32901 | 1-9/16" FV stem, white tip |
| 32902 | 1-15/16 FV stem, blue tip |
| 32903 | 1-11/16 FV stem, blue tip |
| 32909 | Relief valve, long tip for FLUSHBOY |
| 32910 | Relief valve, short tip for PRESTO / REX |

CRANE PRESTO KITS



- Urinal and closet
- Parts kit (4pc) for PRESTO, REX
- Leather diaphragm
- CRANE OEM ref#39002 / 39003

| PART# | DESCRIPTION |
|--------------|---------------------------------|
| 32912 | 4 pc kit for urinal (3/4" stop) |
| 32914 | 4 pc kit for closet (1" stop) |

PRESTO DIAPHRAGM ASSEMBLY



- Fits PRESTO/ EMPIRE
- Major rebuild kits for closet and urinal
- Less seat assembly
- Crane OEM ref#39007 / 39008

| PART# | DESCRIPTION |
|--------------|--------------------------------------|
| 32916 | Major rebuilt kit urinal (3/4" stop) |
| 32918 | Major rebuild kit closet (1" stop) |

FLUSH VALVE COMPLETE REPAIR KITS



- For CRANE, DELANY, PRESTO
- Full parts (6pc) for PRESTO / REX
- Vacuum breaker and stem
- Leather diaphragm
- CRANE OEM ref#39002 / 39003

| PART# | DESCRIPTION |
|--------------|--------------------------------|
| 32906 | 6pc kit for urinal (3/4" stop) |
| 32904 | 6pc kit for closet (1" stop) |

VACUUM BREAKER



- Vacuum breaker for CRANE
- Rubber sleeve
- CRANE OEM ref#302002

| PART# | DESCRIPTION |
|--------------|----------------|
| 32913 | Vacuum breaker |

DIAPHRAGM FOR PRESTO



- Leather diaphragm for PRESTO
- CRANE OEM ref# 302075

| PART# | DESCRIPTION |
|--------------|-------------|
| 32915 | Diaphragm |

FLEX MEMBER



- Rubber flex member for flush valve handle
- CRANE OEM ref# 302022

| PART# | DESCRIPTION |
|--------------|-------------|
| 32917 | Flex member |

OEM numbers, registered trademarks, faucet name, and manufacturer listed above are supplied and listed for your reference only.

FLUSH VALVE PARTS FOR SLOAN

SLOAN FLUSH VALVE HANDLE



- Also Fits ZURN C.P METAL
- FOR ROYAL, REGAL, and CROWN Closet or urinal valves
- OEM ref#B32A

| PART# | DESCRIPTION |
|--------------|--------------------------|
| 32920 | SLOAN flush valve handle |

SLOAN FLUSH VALVE REPAIR KIT



- Repair Kit
- For ROYAL, REGAL, and CROWN closet or urinal valves
- OEM ref#B50A

| PART# | DESCRIPTION |
|--------------|--------------------------|
| 32922 | SLOAN flush valve handle |

SLOAN COMPLETE FLUSH VALVE REBUILD KIT



- Diaphragm, guide, disc etc.(includes self cleaning by pass valve)
- Uses a A156A diaphragm
- New SLOAN 3pc style
- OEM ref#A1041A

| PART# | DESCRIPTION |
|--------------|--------------------|
| 32930 | 1.6 GPM for toilet |

SLOAN PLASTIC FLUSH VALVE GUIDE



- For ROYAL, REGAL, and CROWN Closet or urinal valves
- OEM ref#A163A

| PART# | DESCRIPTION |
|--------------|---------------------------------|
| 32926 | SLOAN plastic flush valve guide |

SLOAN FLUSH VALVE DISC



- For ROYAL & REGAL
- Closet or urinal valves, 2" diameter
- OEM ref#A15A
- Also fits ZURN

| PART# | DESCRIPTION |
|-------------|------------------------|
| 2068 | SLOAN flush valve disc |

SLOAN DIAPHRAGM



- For ROYAL & REGAL
- Closet or urinal valves, 3-1/4" diameter
- OEM ref#A156A
- Also fits ZURN

| PART# | DESCRIPTION |
|-------------|-----------------|
| 2069 | SLOAN diaphragm |

VACUUM BREAKER



- Vacuum breaker repair kit
- SLOAN flush valve, fits SLOAN, ZURN and others
- OEM ref#Z6600B

| PART# | DESCRIPTION |
|--------------|----------------|
| 21842 | Vacuum breaker |

* FOR SLOAN FLUSH VALVE REPAIR TOOL
(PART#992180) SEE PAGE L-19

SLOAN COMPLETE FLUSH VALVE REBUILD KIT



- Relief valve, disc, diaphragm, body guide
- Original SLOAN style

| PART# | SLOAN PART# | FOR |
|--------------|-------------|------------------------|
| 21843 | A42A | 1gpm urinal |
| 21844 | A37A | 1.5gpm urinal |
| 21846 | A36A | 4.5gpm urinal |
| 21847 | A38A | 3.5gpm toilet & urinal |
| 21848 | A41-A | 1.66gpm toilet |

OEM numbers, registered trademarks, faucet name, and manufacturer listed above are supplied and listed for your reference only.

REPAIR/REBUILD KITS

ZURN AQUAFLUSH REPAIR KIT



- For closet and urinal
- Combo Kit
- OEM ref#Z6000

| PART# | DESCRIPTION |
|--------------|---------------------------|
| 32932 | ZURN AQUAFLUSH repair kit |

ZURN AQUAFLUSH REBUILD KIT



- For closet and urinal
- Same as **part#32932** but adds vacuum breaker, handle repair kit and o-ring

| PART# | DESCRIPTION |
|--------------|----------------------------|
| 32934 | ZURN AQUAFLUSH rebuild kit |

FLUSH VALVE REBUILD KIT



- Fits most ROYAL, REGAL, SLOAN ZURN models
- Includes inside parts, vacuum breaker, handle seal kit shut off cup, tailpiece, o-ring, gpf reducers
- OEM ref#A-1002-A

| PART# | DESCRIPTION |
|--------------|-------------------------|
| 21838 | Flush valve rebuild kit |

DELANY REBUILD KIT



- Critical parts for DELANY flush boy shut off valve
- Rebuild kit
- OEM ref#FB44-4AJ

| PART# | DESCRIPTION |
|--------------|--------------------|
| 33955 | DELANY Rebuild Kit |

SLOAN ACTUATOR CARTRIDGE



- Replacement for SLOAN, ROYAL/REGAL
- Sub assembly actuator

| PART# | DESCRIPTION |
|--------------|-------------------------------|
| 32950 | For Hydraulic OEM ref#HY-83-A |
| 32952 | For Solenoid OEM ref#EL-128-A |

OEM numbers, registered trademarks, faucet name, and manufacturer listed above are supplied and listed for your reference only.

REPLACEMENT PARTS FOR TECK

TECK / CAMBRIDGE BRASS UNIVERSAL HANDLE REPAIR KIT



- Except for 82T (pre 1975), and electronic models
- Kit includes following parts:
Handle cage, relief valve, seat washer, spring, o-rings (2), cage, push pin, spring, handle (2), rubber washer, bonnet (2), handle gland (2) plastic insert
- OEM ref#76602 (TV50)

| PART# | DESCRIPTION |
|-------|-------------------|
| 33902 | Handle repair kit |

TECK / CAMBRIDGE BRASS, FLUSH VALVE REPAIR KIT



- Concealed body, all models except for 82T (pre 1975)
- Kit includes:
Regulating screw, fibre gasket (2), diaphragm, handle seat washer, spring (2) leather gasket, flexible washer, push pin, relief valve, o-ring (3), screw, handle cage
- OEM ref#76601 (TV111)

| PART# | DESCRIPTION |
|-------|-------------------|
| 33901 | Flush valve parts |

TECK / CAMBRIDGE BRASS, FLUSH VALVE REPAIR KIT



- Exposed body, all models except for 82T (pre 1975)
- Kit includes:
Fibre gasket (3), diaphragm, handle seat washer (2), leather gasket, flexible washer, push pin, o-ring (6), screw
- OEM ref#76600 (TV107)

| PART# | DESCRIPTION |
|-------|-------------------|
| 33900 | Flush valve parts |

TECK / CAMBRIDGE BRASS, HANDLE CAGE ASSEMBLY



- Except for 82T (pre 1975), and electronic models
- Kit includes handle cage and o-ring
- OEM ref#77191

| PART# | DESCRIPTION |
|-------|-----------------------------|
| 33906 | Universal handle repair kit |

OEM numbers, registered trademarks, faucet name, and manufacturer listed above are supplied and listed for your reference only.

REPLACEMENT PARTS FOR TECK

DELTA / CAMBRIDGE BRASS TEMPUS METERING REPLACEMENT



- DELTA / CAMBRIDGE brass tempus metering
- Replacement cartridge
- For single and 4" centreset faucets
- OEM ref#060160A

| PART# | DESCRIPTION |
|---------------|---------------------------------------|
| 11350 | DELTA / CAMBRIDGE Brass Tempus |
| 11350Q | DELTA / CAMBRIDGE Brass Tempus - bulk |

TECK / CAMBRIDGE BRASS DIAPHRAGM WITH GUIDE



- OEM ref#70230

| PART# | DESCRIPTION |
|--------------|----------------------|
| 33905 | Diaphragm with guide |

TECK / CAMBRIDGE BRASS, DIAPHRAGM



- OEM ref#10316

| PART# | DESCRIPTION |
|--------------|-------------|
| 33903 | Diaphragm |

TECK / CAMBRIDGE BRASS, VB SLEEVE



- For all models including electronic
- Overall length is 2"
- OEM ref#70267

| PART# | DESCRIPTION |
|--------------|-------------|
| 33904 | VB sleeve |

OEM numbers, registered trademarks, faucet name, and manufacturer listed above are supplied and listed for your reference only.

COMMERCIAL A

NOTES

Lined area for notes.

SECTION "B" TUBULAR INDEX

| | | | |
|--|------|---------------------------------|------|
| ABS Pop-Up P.O. | B-11 | Plates - Overflow | B-14 |
| ABS Waste & Overflow Half Kits | B-13 | Plug & Chain P.O. | B-11 |
| Adapters Trap | B-8 | Poly Washer For Tailpieces | B-8 |
| Bar Strainers | B-21 | Pop-Up Drain P.O. | B-10 |
| Basket Strainers Sink | B-20 | P-Traps | B-1 |
| Bell Flange -Tubular | B-9 | P-Traps - Extended | B-3 |
| Box Flange - Tubular | B-9 | Push & Pull W/O Trim Kit | B-16 |
| Brass - Solder Collar | B-7 | Reducing Tailpiece | B-5 |
| C.O. Plugs | B-11 | Repair Kit for P.O. Plugs | B-18 |
| Cable Drive W/O Kits - ABS | B-13 | Replacement Basket Strainers | B-20 |
| Centre Outlet - Continuous Waste | B-4 | Ring - Compression | B-8 |
| Cheater Vent | B-18 | S Bends - Tubular | B-4 |
| Click Top PO/CO Plug | B-12 | Semi Cast P-Traps | B-1 |
| Commercial Lavatory Drains, Open Grid | B-12 | Semi Cast P-Traps - Extended | B-3 |
| Compression Rings | B-8 | Shoe,Waste and Overflow | B-16 |
| Continuous Wastes | B-4 | Sink Strainers | B-19 |
| Coupling - Tubular | B-7 | Sink Strainers | B-20 |
| Crumb Cups | B-21 | Slip Joint Nuts | B-8 |
| Dishwasher Tailpieces | B-6 | Slip Joint Tubular Extensions | B-5 |
| Drain - Commercial Lavatory | B-12 | Solder Collar - Brass | B-7 |
| Drain - Handicap Style, Offset Open Grid | B-12 | Solder Tubular Extensions | B-5 |
| Elbow 45° Tubular | B-7 | Stoppers - Lift &Turn | B-15 |
| Elbow 90° Tubular | B-7 | Stoppers - Tip Toe | B-15 |
| End Outlet, Continuous Waste | B-4 | Stoppers P.O. Plug | B-17 |
| Escutcheons for Tubular | B-9 | Strainer - Sink, Old Style Sink | B-19 |
| Extensions - Slip Joint | B-5 | Strainer - Sink, Double Cup | B-19 |
| Extensions - Tubular Solder | B-5 | Strainer - Sink, KIL Style | B-19 |
| Faceplates - Waste & Overflow | B-14 | Strainer - Sink, Supreme Style | B-19 |
| Flanged Tailpieces | B-5 | Strainer - Tub | B-16 |
| Flanges - Sure Grip | B-9 | Strainers - Bar Style | B-21 |
| Garbage Disposer Shield | B-21 | Strainers - Junior | B-21 |
| Handicap Style Open Grid Lav Drain | B-12 | Supreme Style Sink Strainer | B-19 |
| J Bends - Tubular | B-4 | Sure Grip - Flanges | B-9 |
| KIL Type Sink Strainer | B-19 | Tailpiece - Flanged | B-5 |
| Lift & Turn Drain | B-15 | Tailpiece - Reducing | B-5 |
| Lift & Turn W/O Kits ABS | B-13 | Tailpiece Threaded Both Ends | B-5 |
| Mack Washers | B-15 | Tailpiece Threaded One Ends | B-5 |
| Mechanica IPO /CO Plugs | B-10 | Tailpiece Washers | B-7 |
| Nut - SlipJoint | B-8 | Tailpiece Washers | B-8 |
| Open Grid PO/CO Plugs | B-12 | Tailpieces - Dishwasher | B-6 |
| Overflow Plate - Oversized | B-14 | Tee, Tubular Outlet | B-6 |
| Overflow Plates | B-14 | Threaded Tailpieces TBE | B-5 |
| P.O. Plug & Chain | B-11 | Threaded Tailpieces TOE | B-5 |
| P.O. Plug - Click Top | B-12 | TipToe W/O Trim Kit | B-16 |
| P.O. Plug - Open Grid | B-12 | Tip-Toe Drain Cartridge | B-15 |
| P.O. Plug Combo 50/50 | B-10 | Trap Adapters | B-8 |
| P.O. Plug Repair Kit | B-18 | Trap - Repair PVC | B-13 |
| P.O. Plug Stoppers | B-17 | Trim Kit for Waste & Overflow | B-16 |
| Plate - Oversized Overflow | B-14 | T-Traps | B-2 |

TUBULAR

P-TRAP LESS CLEANOUT



- 20 gauge
- Ground joint connection
- Deep flange
- Brass nuts
- 7-1/2" wall bend
- Brass units less flange

| PART# | FINISH | SIZE |
|----------------|----------------|--------|
| 13860 | Chrome plated | 1-1/4" |
| 13860B | Rough brass | 1-1/4" |
| 13860BN | Brushed nickel | 1-1/4" |
| 13861 | Chrome plated | 1-1/2" |
| 13877 | Rough brass | 1-1/2" |

SEMI CAST P-TRAPS, WITH CLEANOUT



- 17 gauge
- Ground joint
- Semi-cast p-trap with cleanout and flange
- Includes:
 - Cast J bend
 - Deep flange
 - Brass nuts
 - 7-1/2" wall tube
 - Brass units less flange

| PART# | FINISH | SIZE |
|--------------|---------------|--------|
| 13866 | Chrome plated | 1-1/4" |
| 13900 | Rough brass | 1-1/4" |
| 13867 | Chrome plated | 1-1/2" |
| 13905 | Rough brass | 1-1/2" |

TUBULAR

P-TRAP - 22GA



- 22 gauge renovation p-trap
- Zinc nuts
- Ground front
- 7-1/2" wall bend
- Deep flange

| PART# | DESCRIPTION |
|-------|---------------|
| 13859 | 1-1/4" p-trap |

P-TRAP - 17GA



- 17 gauge heavy duty p-traps
- Brass nuts
- Grounded joint connection
- 7-1/2" wall bend with flange
- cUPC approved

| PART# | DESCRIPTION |
|-------|---------------|
| 13868 | 1-1/4" p-trap |
| 13869 | 1-1/2" p-trap |

T-TRAP



- 20 gauge t-trap
- Vessel trap
- 2" trap
- 8" height
- 14" wall bend
- 1-1/4" chrome brass
- Easy to cleanout

| PART# | DESCRIPTION |
|---------|----------------|
| 13919 | Chrome plated |
| 13919BN | Brushed nickel |

TUBULAR

P-TRAPS - EXTENDED VANITY TRAPS



- 20 gauge
- Brass nuts
- Ground front
- 15" wall bend
- Deep flange
- cUPC approved

| PART# | DESCRIPTION |
|--------------|-----------------------|
| 13910 | 1-1/4" Chrome plated |
| 13915 | 1-1/4" Brushed nickel |

SEMI-CAST P-TRAP - EXTENDED



- 17 gauge
- Brass nuts
- Ground joint
- 12" wall bend
- Deep flange
- cUPC approved

| PART# | DESCRIPTION |
|--------------|----------------------|
| 13912 | 1-1/4" Chrome plated |
| 13917 | 1-1/2" Chrome plated |

SEMI-CAST P-TRAP - EXTENDED WITH CLEANOUT



- 17 gauge
- Brass nuts
- Ground joint
- 12" wall bend
- Deep flange
- cUPC approved

| PART# | DESCRIPTION |
|--------------|----------------------|
| 13913 | 1-1/4" with cleanout |
| 13918 | 1-1/2" with cleanout |

TUBULAR

J BEND - CHROME PLATED



- 20 gauge
- Chrome plated
- Brass nuts
- cUPC approved

S BEND - CHROME PLATED



- 20 gauge
- Chrome plated brass nuts
- Deep flange

PART# DESCRIPTION

- 13862** J bend 1-1/4"
- 13863** J bend 1-1/2"

PART# DESCRIPTION

- 13864** S bend 1-1/4"
- 13865** S bend 1-1/2"

END OUTLET DIRECT CONNECT



- 20 gauge
- 16" centres
- Rough brass
- Brass nuts
- cUPC approved

END OUTLET SLIP JOINT STYLE



- 20 gauge
- 16" centres
- Rough brass
- Brass nuts
- cUPC approved

PART# DESCRIPTION

- 13940** 1-1/2" diameter

PART# DESCRIPTION

- 13941** 1-1/2" diameter

CENTRE OUTLET DIRECT CONNECT STYLE



- 20 gauge
- 16" centres
- Rough brass
- cUPC approved

END OUTLET DIRECT CONNECT STYLE



- 20 gauge
- 16" centres
- Rough brass
- With dishwasher tailpiece
- 1/2" hose clamp or copper sweat branch
- cUPC approved

PART# DESCRIPTION

- 13942** 1-1/2" diameter

PART# DESCRIPTION

- 13943** 1-1/2" diameter

TUBULAR

FLANGED STRAINER TAILPIECE



| PART# | GAUGE | SIZE | FINISH | LENGTH |
|--------|-------|--------|---------------|--------|
| 13858 | 22 | 1-1/2" | Rough brass | 2-5/8" |
| 13854 | 22 | 1-1/2" | Rough brass | 4" |
| 13854C | 22 | 1-1/2" | Chrome plated | 4" |
| 13855 | 22 | 1-1/2" | Rough brass | 6" |
| 13848 | 22 | 1-1/2" | Rough brass | 8" |
| 13849 | 22 | 1-1/2" | Rough brass | 12" |

SLIP JOINT TUBULAR EXTENSIONS



| PART# | GAUGE | SIZE | FINISH | LENGTH |
|-------|-------|--------|---------------|--------|
| 13840 | 22 | 1-1/4" | Chrome plated | 6" |
| 13841 | 22 | 1-1/4" | Chrome plated | 8" |
| 13842 | 22 | 1-1/4" | Chrome plated | 12" |
| 13843 | 22 | 1-1/2" | Chrome plated | 6" |
| 13844 | 22 | 1-1/2" | Chrome plated | 8" |
| 13845 | 22 | 1-1/2" | Chrome plated | 12" |

SOLDER TUBULAR EXTENSIONS



| PART# | GAUGE | SIZE | FINISH | LENGTH |
|-------|-------|--------|---------------|--------|
| 13856 | 22 | 1-1/4" | Chrome plated | 6" |
| 13846 | 22 | 1-1/4" | Chrome plated | 8" |
| 13857 | 22 | 1-1/2" | Chrome plated | 6" |
| 13847 | 22 | 1-1/2" | Chrome plated | 8" |

THREADED TAILPIECE THREADED BOTH ENDS



| PART# | GAUGE | SIZE | FINISH | LENGTH |
|-------|-------|-------|---------------|--------|
| 13881 | 20 | 1-1/4 | Chrome plated | 4" |
| 13851 | 20 | 1-1/4 | Chrome plated | 6" |
| 13878 | 20 | 1-1/4 | Chrome plated | 8" |
| 13879 | 20 | 1-1/4 | Chrome plated | 12" |
| 13852 | 20 | 1-1/2 | Chrome plated | 6" |
| 13883 | 20 | 1-1/2 | Chrome plated | 8" |
| 13885 | 20 | 1-1/2 | Chrome plated | 12" |

THREADED TAILPIECE THREADED ONE END



| PART# | GAUGE | SIZE | FINISH | LENGTH |
|-------|-------|-------|---------------|--------|
| 13884 | 20 | 1-1/4 | Chrome plated | 4" |
| 13886 | 20 | 1-1/4 | Chrome plated | 6" |
| 13888 | 20 | 1-1/4 | Chrome plated | 8" |
| 13880 | 20 | 1-1/2 | Chrome plated | 6" |
| 13882 | 20 | 1-1/2 | Chrome plated | 8" |

REDUCING TAILPIECE



| PART# | GAUGE | SIZE | FINISH | LENGTH |
|-------|-------|---------------|---------------|--------|
| 13890 | 20 | 1-1/2 x 1-1/4 | Chrome plated | 8" |

TUBULAR

DISHWASHER TAILPIECE THREADED TOP



- 20 gauge
- Rough brass
- 1-1/2" size
- Threaded top
- Dishwasher Branch: 1/2"

PART# DESCRIPTION

- 13891** 6" long
- 13896** 8" long

DISHWASHER TAILPIECE DIRECT CONNECT TOP 1/2"



- 20 gauge
- Rough brass
- 1-1/2" size
- Direct connect top
- Dishwasher branch: 1/2"

PART# DESCRIPTION

- 13892** 6" long
- 13895** 8" long

DISHWASHER TAILPIECE DIRECT CONNECT TOP 3/4"



- 20 gauge
- Chrome or rough brass
- 1-1/2" size
- Direct connect top
- Dishwasher branch: 3/4" sweat copper

PART# DESCRIPTION

- 13853** 6" long, chrome plated
- 13853B** 6" long, rough brass

DISHWASHER TAILPIECE SLIP JOINT TOP CONNECTOR



- 22 gauge
- Rough brass
- 1-1/2" size
- Slip joint top connector
- Dishwasher branch: hose thread or 1/2" sweat copper

PART# DESCRIPTION

- 13897** 6" long

17 GAUGE CENTRE OUTLET TEE



- 17 gauge
- Chrome plated
- 1-1/2" size

PART# DESCRIPTION

- 13923** Centre outlet tee

17 GAUGE END OUTLET TEE



- 17 gauge
- Chrome plated
- 1-1/2" size

PART# DESCRIPTION

- 13922** End outlet tee

TUBULAR

B

TUBULAR

20 GAUGE TEE



- 20 gauge
- Chrome plated
- 1-1/2" size

| PART# | DESCRIPTION |
|-------|-------------|
| 13926 | 1/2" tee |

20 GAUGE COUPLING



- 20 gauge
- Chrome plated

| PART# | DESCRIPTION |
|-------|-----------------|
| 13925 | 1-1/4" coupling |
| 13924 | 1-1/2" coupling |

20 GAUGE ELBOW 45°



- 20 gauge
- Chrome plated

| PART# | DESCRIPTION |
|-------|-------------------------|
| 13928 | 1-1/4" elbow 45 degrees |
| 13927 | 1-1/2" elbow 45 degrees |

20 GAUGE ELBOW 90°



- 20 gauge
- Chrome plated

| PART# | DESCRIPTION |
|-------|-------------------------|
| 13930 | 1-1/4" elbow 90 degrees |
| 13929 | 1-1/2" elbow 90 degrees |

SOLDER COLLAR - BRASS



- 1-1/2" thread

| PART# | DESCRIPTION |
|-------|----------------------------|
| 1314 | For Tubular, 1-1/2" collar |
| 1315 | For CWT, 1-5/8" collar |

TAILPIECE WASHER



- Cloth inserted rubber washer
- For tailpiece

| PART# | DESCRIPTION |
|-------|------------------|
| 2211 | Tailpiece washer |

TUBULAR

SLIP JOINT NUT



| PART# | SIZE | MATERIAL | FINISH |
|-------|-----------------|---------------|--------|
| 1330C | 1-1/4" | Zinc die cast | Chrome |
| 1331C | 1-1/2" x 1-1/4" | Zinc die cast | Chrome |
| 1333C | 1-1/2" | Zinc die cast | Chrome |
| 1333P | 1-1/2" | Zinc die cast | Rough |
| 1336 | 1-1/4" | Brass | Rough |
| 1336C | 1-1/4" | Brass | Chrome |
| 1337 | 1-1/2" x 1-1/4" | Brass | Rough |
| 1337C | 1-1/2" x 1-1/4" | Brass | Chrome |
| 1338 | 1-1/2" | Brass | Rough |
| 1338C | 1-1/2" | Brass | Chrome |
| 1339 | 2" | Brass | Rough |
| 1339C | 2" | Brass | Chrome |

POLY WASHER FOR TAILPIECES



| PART# | SIZE | DESCRIPTION |
|-------|-----------------|-------------|
| 2214 | 1-1/2" | Beveled |
| 2218 | 1-1/2" x 1-1/4" | Beveled |
| 2219 | 1-1/4" | Beveled |
| 2222 | 1-1/2" | Flanged |

TRAP ADAPTERS



FEMALE COPPER SWEAT UNDER MPT

- Slip nut: rough brass
- Compression ring: brass



FEMALE IPS

| PART# | A | DESCRIPTION |
|-------|--------|---------------------|
| 1942 | 1-1/4" | B male IPS: 1-1/4" |
| 1943 | 1-1/4" | B male IPS:1-1/2" |
| 1944 | 1-1/2" | B male IPS:1-1/2" |
| 1945 | 1-1/4" | B female IPS:1-1/4" |
| 1946 | 1-1/4" | B female IPS:1-1/2" |
| 1947 | 1-1/2" | B female IPS:1-1/2" |

COMPRESSION RINGS ONLY



| BRASS | TYPE | SIZE |
|-------|-------|--------|
| 1990 | Brass | 1-1/4" |
| 1992 | Brass | 1-1/2" |

FLANGES & PLATES

FLANGE - SURE GRIP

- Chrome plated or polished brass



| PART# | IPS | CWT | OD | TUBULAR | HEIGHT |
|--------|------------------|--------|--------|---------|--------|
| 1224 | - | - | 3" | 1-1/2" | 7/16" |
| 1225 | 3/8" | - | 2-1/2" | - | 25/64" |
| 1226 | 1/2" | - | 2-1/2" | - | 25/64" |
| 1227 | 3/4" | - | 2-1/2" | - | 25/64" |
| 1228 | 1-1/2" | - | 3" | - | 7/16" |
| 1229 | 2" | - | 3-1/4" | - | 43/64" |
| 1230 | - | 1/2" | 2-1/2" | - | 13/32" |
| 1230PB | (Polished Brass) | 1/2" | 2-1/2" | - | 13/32" |
| 1231 | - | 3/4" | 2-1/2" | - | - |
| 1232 | 1-1/4" | 1-1/2" | 3" | - | 1/2" |
| 1233 | 1" | - | 2-3/4" | - | 1/2" |
| 1240 | - | 2" | 3-1/2" | - | 25/64" |
| 1241 | - | 1" | 2-3/4" | - | 1/2" |
| 1244 | - | - | 3" | 1-1/4" | 7/16" |

BOX FLANGE - SURE GRIP



- Chrome plated
- 1-3/4" height

| PART# | IPS | OD | TUBULAR |
|-------|--------|----|---------|
| 1234 | 1-1/4" | 3" | - |
| 1235 | 1-1/2" | 3" | - |
| 1236 | - | 3" | 1-1/4" |
| 1237 | - | 3" | 1-1/2" |

FLANGE - EXTRA WIDE SURE GRIP



- Chrome plated

| PART# | IPS | OD | TUBULAR | HEIGHT |
|-------|--------|--------|---------|--------|
| 1238 | 1-1/4" | 3-1/2" | - | 1/2" |
| 1239 | 2" | 3-1/2" | - | 1/2" |
| 1243 | - | 3-1/2" | 2" | 1/2" |

BELL FLANGE - SURE GRIP



- Chrome plated or brushed nickel (part#2853BN)

| PART# | IPS | CWT | OD | TUBULAR | HEIGHT |
|--------|----------------|------|--------|---------|--------|
| 2841 | 3/8" | - | 2-1/2" | - | 1-1/4" |
| 2842 | 1/2" | - | 2-1/2" | - | 1-1/4" |
| 2843 | 3/4" | - | 2-1/2" | - | 1-1/4" |
| 2844 | 1-1/4" | - | 3" | - | 1-1/4" |
| 2845 | - | 1/2" | 2-1/2" | - | 1-1/4" |
| 2846 | 1-1/2" | - | 3" | - | 1-1/4" |
| 2848 | - | 3/8" | 2-1/2" | - | 1-1/4" |
| 2853 | - | - | 3" | 1-1/4" | 1-1/4" |
| 2853BN | Brushed Nickel | - | 3" | 1-1/4" | 1-1/4" |
| 2854 | - | - | 3" | 1-1/2" | 1-1/4" |

TUBULAR

P.O & C.O. PLUGS

POP-UP DRAIN P.O.



- 3 pc mechanical pop-up
- With lift rod, plunger and linkage
- Chrome plated brass
- Polished brass and brushed nickel finishes also available
- Box packaged
- cUPC approved

COMBO POP-UP P.O.



- 50/50 unit
- ABS body
- C.P. brass top
- With lift rod, plunger and linkage
- Box packaged
- cUPC approved

| PART# | DESCRIPTION |
|---------------|---------------------|
| 9991 | 3 pc Chrome |
| 9991PB | 3 pc Polished brass |
| 9991BN | 3 pc Brushed nickel |

| PART# | DESCRIPTION |
|-------------|------------------|
| 9990 | 3 pc ABS / brass |

POP-UP DRAIN C.O.



- 3 pc mechanical P.O. plug
- With lift rod, plunger and linkage
- Chrome plated brass
- Box packaged
- CSA approved

POP UP DRAIN 1 PC P.O.



- 1 pc unit
- With lift rod, plunger and linkage
- Chrome plated brass
- Box packaged

| PART# | DESCRIPTION |
|-------------|-------------|
| 9989 | 3 pc chrome |

| PART# | DESCRIPTION |
|--------------|-------------|
| 9991E | 1 pc chrome |

TUBULAR

B

ABS POP-UP P.O.



- P.O. Plug
- 3 pc all ABS
- Box packaged
- CSA approved

| PART# | DESCRIPTION |
|-------|--------------|
| 9994 | 3 pc all ABS |

TUBULAR

PLUG & CHAIN P.O., 1 PIECE



- Chrome plated brass with overflow
- 1 piece P.O. plug
- 8" long
- Box packaged
- With stopper and chain
- cUPC approved

| PART# | DESCRIPTION |
|-------|------------------------------|
| 9995 | 1 piece P.O. plug & chain 8" |

PLUG & CHAIN P.O., 3 PIECE



- Chrome plated brass with overflow
- With stopper and chain
- Available with 6" or 4" tailpiece
- Box packaged
- cUPC approved

| PART# | DESCRIPTION |
|-------|------------------------|
| 9993 | 3 pc with 6" tailpiece |
| 9997 | 3 pc with 4" tailpiece |

TUBULAR

CLICK TOP PO/CO PLUG



- All brass design
- 1-1/4" x 6" tailpiece
- 2 piece style
- Push top open and close
- PO or CO styles
- cUPC approved

| PART# | DESCRIPTION |
|---------------|------------------------|
| 9998 | PO plug chrome |
| 9998BN | PO plug brushed nickel |
| 9999 | CO plug chrome |
| 9999BN | CO plug brushed nickel |

DRAIN - COMMERCIAL LAV, OPEN GRID



- 17 gauge
- With tail piece
- Highest quality
- Chrome plated brass
- 1-1/4"x 6" tailpiece
- Brass locknut
- Rubber gasket
- cUPC approved

| PART# | DESCRIPTION |
|-------------|-------------|
| 9992 | PO Style |
| 9996 | CO Style |

DRAIN - HANDICAP STYLE LAV, OPEN GRID



- 17 gauge
- Highest quality
- Chrome plated brass
- 1-1/4"x 9" waste elbow
- Brass locknut
- Rubber gasket
- cUPC approved

| PART# | DESCRIPTION |
|---------------|-------------|
| 1177TP | PO Style |
| 1178TP | CO Style |

ABS WASTE & OVERFLOW KITS

WASTE & OVERFLOW HALF KIT (T/T)



- ABS waste and overflow half kits
- With tip toe style tub cartridge, brass stem, zinc body
- Includes the ABS tee fitting and all hardware
- Chrome and brushed nickel finishes
- cUPC approved

WASTE & OVERFLOW HALF KIT (L/T)



- ABS waste and overflow half kits
- With lift & turn tub cartridge, brass stem, zinc body
- Includes the ABS tee fitting and all hardware
- Chrome and brushed nickel finishes
- cUPC approved

PART# DESCRIPTION

| | |
|----------------|----------------|
| 13950 | Chrome |
| 13950BN | Brushed nickel |

PART# DESCRIPTION

| | |
|----------------|----------------|
| 13955 | Chrome |
| 13955BN | Brushed nickel |

WASTE & OVERFLOW HALF KIT CABLE DRIVE



- ABS waste and overflow half kits
- With cable drive assembly
- Cable is 35" long
- Includes the ABS tee fitting and all hardware
- Chrome and brushed nickel finishes
- Brass drain, stainless steel polished faceplate
- cUPC approved

PART# DESCRIPTION

| | |
|----------------|----------------|
| 13960 | Chrome |
| 13960BN | Brushed nickel |

TUBULAR REPAIR TRAP



- PVC repair trap for 1-1/4" or 1-1/2" drains
- Easy to repair and replace plastic or metal traps
- Simply clamp on

PART# DESCRIPTION

| | |
|----------------|----------------|
| FC150FT | PVC drain trap |
|----------------|----------------|

TUBULAR

OVERFLOW PLATE WITH TRIP LEVER



- Square handle
- Covers 3-1/4" hole
- 2" bolt hole centres

| PART# | FINISH | W/1148 BOLTS |
|-------------|--------|--------------|
| 1150 | Chrome | None |
| 1157 | Chrome | 2 |

OVERFLOW PLATE, 2 HOLE



- Covers 3-1/4" hole
- 2" bolt hole centres

| PART# | DESCRIPTION | W/1148 BOLTS |
|-------------|-------------|--------------|
| 1154 | Chrome | None |
| 1160 | Chrome | 2 |

TUB OVERFLOW PLATE



- Covers 3-1/4" hole

| PART# | FINISH | W/1148 BOLTS |
|--------------|--------|--------------|
| 1152 | Chrome | None |
| 1152Q | Chrome | None |
| 1159 | Chrome | 1 |

ABS TUB OVERFLOW PLATE



- Chrome plated ABS
- Covers 3-1/4" hole
- Includes plastic tie bar & gasket
- 3 screws

| PART# | DESCRIPTION |
|-------------|------------------------|
| 1158 | ABS tub overflow plate |

OVERSIZED FIT-ALL OVERFLOW PLATE



- Chrome plastic overflow plate
- Oversized 3-1/2" diameter
- Replace old one and two hole plates
- Snaps on for a clean perfect finish
- Available in brushed nickel or oil rubbed bronze on request

| PART# | DESCRIPTION |
|--------------|---|
| 1153 | Oversized FIT-ALL overflow plate |
| 1153Q | Oversized FIT-ALL overflow plate - bulk |

TUBULAR

WASHER - WASTE & OVERFLOW



- Sponge rubber

MACK WASHER



- For P.O. and C.O. plugs
- Variety of sizes
- 10 per pack

| PART# | DESCRIPTION |
|-------------|----------------------------|
| 2091 | 2-1/8" x 3-7/16" x beveled |
| 2092 | 1-7/8" x 2-7/8" x 3/8" |

| PART# | SIZE |
|-------------|--------------|
| 2071 | 1-1/4" wide |
| 2070 | 1-5/16" wide |
| 2072 | 1-3/8" |
| 2073 | 1-1/2" |
| 2074 | 1-1/4" |

TIP-TOE DRAIN CARTRIDGE



- Plastic cartridge, rubber seal
- ABS Cover, with 5/16" Stem

LIFT & TURN STOPPER



- Zinc cover CP, with 3/8" stem

| PART# | DESCRIPTION |
|--------------|-------------------------|
| 13786 | Tip-toe drain cartridge |

| PART# | DESCRIPTION |
|--------------|---------------------|
| 13785 | Lift & turn stopper |

LIFT & TURN DRAIN



- Chrome plated brass
- Complete assembly
- Universal design fits most waste / overflow models

TIP-TOE DRAIN



- Chrome plated brass
- Complete assembly
- Universal design fits most waste / overflow models

| PART# | DESCRIPTION |
|--------------|--------------------------------|
| 1381 | 1-1/4"IPS |
| 1382 | 1-1/2"IPS |
| 1381W | 1-1/4"IPS - replacement washer |
| 1382W | 1-1/2"IPS - replacement washer |

| PART# | DESCRIPTION |
|--------------|--------------------------------|
| 1383 | 1-1/4"IPS |
| 1384 | 1-1/2"IPS |
| 1381W | 1-1/4"IPS - replacement washer |
| 1382W | 1-1/2"IPS - replacement washer |

TUBULAR

SNAP & PRESS STOPPER



- For popular fine thread strainers
- Rubber seal
- ABS cover

| PART# | DESCRIPTION |
|-------|------------------------|
| 13787 | 1/4" stem, ABS stopper |

WASTE AND OVERFLOW TRIM KIT



- Available in chrome, polished brass, brushed nickel
- Universal Fit for 1-1/2" & 1-3/4"
- Blister packaged

| PART# | DESCRIPTION |
|-------|------------------------------------|
| 13774 | Tip toe style - chrome |
| 13775 | Tip toe style - polished brass |
| 13776 | Tip toe style - brushed nickel |
| 13777 | Push n pull style - chrome |
| 13778 | Push n pull style - polished brass |
| 13779 | Push n pull style - brushed nickel |

WASTE SHOE



- 17 gauge tube
- Brass
- Fine thread
- Top quality, excellent seal

| PART# | DESCRIPTION |
|-------|-------------|
| 1372 | 1-1/2" |

TUB STRAINER



- Fine thread body
- 1/4" thread bottom post
- Fits 1-1/2" drains

| PART# | DESCRIPTION |
|-------|-----------------------------------|
| 1374 | Tub strainer, chrome plated brass |

TUBULAR

B

TUBULAR

PO PLUG STOPPER - AM-STD



| PART# | LENGTH x STOPPER DIAMETER |
|-------|---------------------------|
| 14006 | 4.71" x 1.48" |

PO PLUG STOPPER - DELTA



| PART# | LENGTH x STOPPER DIAMETER |
|-------|---------------------------|
| 14005 | 5.09" x 1.35" |

PO PLUG STOPPER - ELJER



| PART# | LENGTH x STOPPER DIAMETER |
|-------|---------------------------|
| 14007 | 4.15" x 1.29" |

PO PLUG STOPPER - MOEN



| PART# | LENGTH x STOPPER DIAMETER |
|-------|---------------------------|
| 14008 | 5" x 1.23" |
| 14009 | 4.35" x 1.23" |
| 14010 | 3.95" x 1.33" |

PO PLUG STOPPER - PRICE PFISTER



| PART# | LENGTH x STOPPER DIAMETER |
|-------|---------------------------|
| 14011 | 3.79" x 1.23" |

PO PLUG STOPPER - STERLING



| PART# | LENGTH x STOPPER DIAMETER |
|-------|---------------------------|
| 14012 | 4.24" x 1.33" |

TUBULAR

PO PLUG STOPPER - VALLEY



| PART# | LENGTH x STOPPER DIAMETER |
|-------|---------------------------|
| 14013 | 4.62" x 1.51" |

PO PLUG STOPPER - UNIVERSAL



| PART# | LENGTH x STOPPER DIAMETER |
|-------|---------------------------|
| 14014 | 5.00" x 1.22" |
| 14015 | 5.09" x 1.35" |

POP-UP REPAIR KIT



- 3pcs lever kit for P.O. & C.O. plugs

| PART# | DESCRIPTION |
|-------|-------------------|
| 9991R | Pop-up repair kit |

CHEATER VENT



- Remodeling
- A quick solution to a tough problem
- Non-corroding ABS construction
- Replaces secondary plumbing venting
- Tested to NSF-24-19
- Withstands greater than 25lbs back pressure
- Actuates with less than 1/2lb PSI
- Maintains a 2.8" water column

| PART# | DESCRIPTION |
|-------|--------------|
| 2066 | Cheater vent |

TUBULAR

STRAINER - SINK DOUBLE CUP



- Deep well sink strainer
- Stainless steel basket and strainer
- Fits sink openings 3-1/2" to 4"
- Double cup design for easy installation
- Positive sealing crumb cup with rolled edge

| PART# | DESCRIPTION |
|---------|------------------------------|
| 2010DCT | With brass tail piece 2-3/4" |

STRAINER - SINK, SUPREME STYLE



- Stainless steel double cup strainer
- Arrow clip style basket
- Fits 3-1/2" to 4" sink openings
- Positive sealing crumb cup
- Brass shank and tailpiece

| PART# | DESCRIPTION |
|-------|------------------------------|
| 2010B | With brass tail piece 2-3/4" |

SINK STRAINER - KIL STYLE



- "KIL" style strainer basket
- Fits 3-1/2" - 4" drains
- Stainless steel strainer
- Brass shank and tailpiece
- One per box

| PART# | DESCRIPTION |
|-------|--|
| 2011 | "KIL" sink strainer, with brass tailpiece 2-3/4" |

STRAINER - OLD STYLE SINK



- 4-1/2" stainless steel body with strainer
- 3-1/2" opening with brass lock nut with tailpiece

| PART# | DESCRIPTION |
|-------|---------------------------|
| 2010 | Strainer - old style sink |

TUBULAR

UNIVERSAL FIT



- Universal fit "Arrow Clip" strainers
- Stainless steel with chrome plated brass knob and short spring steel clip closure

TWIST & SEAL



- "Twist & Seal" strainer
- Stainless Steel mechanism with positive seating metal stopper
- Chrome plated knob and brass stem

| PART# | DESCRIPTION |
|--------------|-------------------------------|
| 2012 | "Arrow clip" strainers |
| 2012Q | "Arrow clip" strainers - bulk |

| PART# | DESCRIPTION |
|---------------|-------------------------|
| 20127 | Twist & seal - packaged |
| 20127Q | Twist & seal - bulk |

CENTRE POST STYLE



- Deep drawn stainless steel construction with rolled edges

DROP CENTRE NEOPRENE SEAL



- Deep drawn stainless steel construction with rolled edges

| PART# | DESCRIPTION |
|---------------|--------------------------|
| 20125 | Centre post style |
| 20125Q | Centre post style - bulk |

| PART# | DESCRIPTION |
|---------------|---------------------------------|
| 20128 | Drop centre neoprene seal |
| 20128Q | Drop centre neoprene seal- bulk |

4 DIMPLE PUSH DOWN



- Deep drawn stainless steel construction with rolled edges

"KIL" STYLE BASKET STRAINER



- Deep drawn stainless steel construction with rolled edges

| PART# | DESCRIPTION |
|---------------|---------------------------|
| 20126 | 4 dimple push down |
| 20126Q | 4 dimple push down - bulk |

| PART# | DESCRIPTION |
|---------------|------------------------------------|
| 20129 | "KIL" style basket strainer |
| 20129Q | "KIL" style basket strainer - bulk |

TUBULAR

GARBAGE DISPOSER SHIELD



| PART# | DESCRIPTION |
|-------------|-------------------------|
| 1358 | Garbage disposer shield |

STRAINER - JUNIOR BASKET



- For 2" - 2-1/2" outlets
- Stainless steel body and basket
- Complete with washers and nuts
- cUPC approved



| PART# | DESCRIPTION |
|--------------|---------------|
| 1361 | Complete unit |
| 1361B | Basket only |

STRAINER - JUNIOR DUO

For 2" - 2-1/2" Outlets



- For 2" - 2-1/2" outlets
- Stainless steel body and basket
- Complete with washers and nuts
- cUPC approved



| PART# | DESCRIPTION |
|--------------|---------------|
| 1365 | Complete unit |
| 1365B | Basket only |

TRAY PLUG



- For 2" - 2-1/2" outlets
- Stainless body
- With plug
- Complete with washer & nuts
- cUPC approved



| PART# | DESCRIPTION |
|-------------|-------------|
| 1370 | Tray plug |

CRUMB CUP



- Chrome plated brass
- Can be used with **part#1370**

| PART# | DESCRIPTION |
|-------------|---|
| 1341 | Fits sink - 1-7/8" x 1" |
| 1344 | Fits lavatory less post - 1-1/4" x 11/16" |

STRAINER - FLAT DUPLEX



- For 2" - 2-1/2" outlets
- Stainless steel body and strainer
- Complete with washers and nuts
- cUPC approved



| PART# | DESCRIPTION |
|-------------|------------------------|
| 1371 | Strainer - flat duplex |

B

NOTES

TUBULAR

SECTION "C" TOILET REPAIR INDEX

| | | | |
|----------------------------------|------|----------------------------------|------|
| ABS Flush Valves | C-17 | KORKY® Quietfill Fill Valve | C-20 |
| Am/STD Actuators | C-10 | Levers for Toilets | C-3 |
| Am/STD Tank Levers | C-3 | Long Closet Bolts | C-1 |
| Am/STD Toilet Flappers | C-10 | LynCar Fill Valve | C-23 |
| Ballcock Repair Parts | C-26 | MANFIELD Style Flush Valve | C-17 |
| Ballcock, Mini | C-19 | MANFIELD Style Flush Valves | C-22 |
| Ballcocks | C-20 | MANFIELD Tank Lever | C-8 |
| Bolt - Tank To Bowl - Sets Brass | C-2 | Mini Pilot Ballcock | C-19 |
| Bolts & Nuts for Closet | C-1 | Nut - Coupling Ballcock | C-26 |
| Bolts, Plastic, Toilet | C-2 | Overflow Tube, Toilet | C-26 |
| Brass Closet Bolts | C-1 | Pipe Snap Covers | C-30 |
| Brass Float Rods | C-26 | Plastic Closet Bolts | C-1 |
| Brass Floor Flange Toilet | C-28 | Plastic Flush Valves | C-17 |
| Brass Flush Valves | C-17 | Plastic Toilet tank Lid | C-25 |
| Break-Away Closet Bolt | C-1 | Polyurethane Gaskets for Toilets | C-27 |
| Cap - Toilet Plastic | C-2 | Quick Ring Repair Flanges | C-29 |
| Closet Bolt, Plastic | C-1 | Repair Flanges, Quick Ring | C-29 |
| Closet Bolts, Brass | C-1 | Repair Plate Wobbly Floor | C-30 |
| Closet Flange Replacement - 3" | C-28 | Seat-Toilet Stabilizer | C-2 |
| Coast 1B1 Fill Valves | C-22 | Shims for Toilet | C-26 |
| Coastmaster Toilet Flappers | C-11 | Shoe, Toilet Cover | C-25 |
| Covers for Pipe Plastic | C-30 | SLOAN Toilet Cartridge | C-25 |
| CRANE Toilet Flappers | C-11 | Sponge Rubber Flange Gaskets | C-27 |
| Dual Flush Fill Valve | C-19 | Street Flange ABS - 3" | C-28 |
| ELJER Tank Levers | C-6 | Tank Levers | C-3 |
| ELJER Toilet Flappers | C-12 | Tank To Bowl Bolts Brass | C-2 |
| Extension Kit for Toilets | C-28 | Tank to Bowl Gaskets | C-2 |
| Fill Valve Dual Flush | C-19 | Tank To Bowl Set - Brass | C-2 |
| Fill Valves by Korky | C-20 | Tank To Bowl Set - Kohler | C-15 |
| Fill Valves Coastmaster | C-22 | Toilet - Seat Stabilizer | C-2 |
| Flanges, Quick Ring | C-29 | Toilet / Floor Extension Rings | C-28 |
| Flappers - Toilet | C-10 | Toilet Caps | C-2 |
| Float Rods - Brass | C-26 | Toilet Cover Shoe | C-25 |
| Floor Repair Plate | C-30 | Toilet Flange Gaskets | C-27 |
| Fluidmaster Dual Flush Valve | C-19 | Toilet Flappers | C-10 |
| Fluidmaster Fill Valves | C-21 | Toilet Flappers by KORKY | C-14 |
| Fluidmaster Fixer Kit | C-21 | Toilet Floats - Plastic | C-26 |
| Fluidmaster Tank Levers | C-9 | Toilet Floor flange ABS | C-28 |
| Flush Valves ABS 2" & 3" | C-17 | Toilet Floor Flange Brass | C-28 |
| Flush Valves, Brass & Plastic | C-17 | Toilet Seat Bolts, Plastic | C-2 |
| Frugal Flapper | C-12 | Toilet Shims | C-26 |
| Gaskets - Wax for Toilet | C-27 | Toilet Tank Levers | C-3 |
| Gaskets- Tank To Bowl | C-2 | Toilet Tank Lids - Plastic | C-25 |
| Hoover Style Fill Valves | C-22 | TOTO Fill Valve | C-19 |
| KOHLER 1B1X Conversion Kit | C-22 | TOTO Tank Levers | C-8 |
| KOHLER Tank Levers | C-7 | TOTO Toilet Flappers | C-15 |
| KOHLER Tank to Bowl Gasket | C-15 | Tube, Chrome Brass Cover | C-30 |
| KOHLER Toilet Flappers | C-13 | Universal Toilet Tank Levers | C-4 |
| KORKY Toilet Flappers | C-13 | Washer, Brass Oval | C-1 |
| KORKY Flush Valve | C-18 | Wax Gaskets for Toilet | C-27 |

CLOSET BOLTS, SCREWS, NUTS & WASHERS

TOILET REPAIR

BRASS PLATED STEEL CLOSET BOLTS

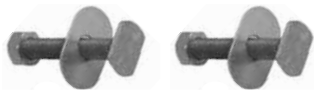

- 2 brass plated steel bolts
- 2 brass plated steel nuts
- 2 brass plated steel washers
- Packaged in pairs

ALL BRASS CLOSET BOLTS



- 2 solid brass bolts
- 2 solid brass nuts
- 2 brass washers
- Packaged in pairs

| PART# | DESCRIPTION |
|-------|-------------|
|-------|-------------|

81 5/16" x 2-1/4" with washers and nuts

| PART# | DESCRIPTION |
|-------|-------------|
|-------|-------------|

82 5/16" x 2-1/4" with oval washers

82R 5/16" x 2-1/4" with round washers

LONG BRASS OVAL WASHER



- 2 solid brass bolts
- 2 solid brass nuts
- 2 solid brass oval washers
- Packaged in pairs

PLASTIC BOLT ROUND WASHER



- 2 plastic bolts
- 2 plastic nuts
- 2 plastic round washers
- Packaged in pairs

| PART# | DESCRIPTION |
|-------|-------------|
|-------|-------------|

83 5/16" x 3-1/2"

| PART# | DESCRIPTION |
|-------|-------------|
|-------|-------------|

84 5/16" x 2-1/4"

BREAK-AWAY OVAL WASHER



- 2 brass bolts
- 2 brass nuts
- 2 brass oval washers
- Packaged in pairs

BOLT ONLY



- Solid brass

| PART# | DESCRIPTION |
|-------|-------------|
|-------|-------------|

82BB 5/16" x 2-1/4"

| PART# | DESCRIPTION |
|-------|-------------|
|-------|-------------|

112 5/16" x 2-1/4"

113 5/16" x 3-1/2"

NUT - BRASS



- Rough brass finish

WASHER - CLOSET BOLT - BRASS



- Rough brass finish

| PART# | DESCRIPTION |
|-------|-------------|
|-------|-------------|

133 5/16" open nut

| PART# | DESCRIPTION |
|-------|-------------|
|-------|-------------|

142 Round washer

149 Oval washer

C
CLOSET BOLTS, SCREWS, NUTS & WASHERS

BOLT - TANK TO BOWL - SETS BRASS



- 2 - brass bolts 5/16" x 3"
- 4 - brass hex nuts
- 4 - cloth inserted rubber washers
- 4 - brass washers

| PART# | DESCRIPTION |
|-------|------------------------------------|
| 237 | Bolt - tank to bowl - sets - brass |
| 232 | Bolt only |
| 242 | Washer only, rubber |

TANK - TO BOWL CONNECTOR KIT



- 1 rubber gasket
- 2 - brass bolts 5/16" x 3"
- 4 - brass hex nuts
- 4 - cloth inserted rubber washers
- 4 - plated brass washers

| PART# | DESCRIPTION |
|-------|---------------------------|
| 437 | Regular gasket |
| 438 | CRANE red gasket recessed |
| 439 | AM-STD gasket recessed |

GASKET ONLY - TANK TO BOWL



- Sponge rubber

| PART# | DESCRIPTION |
|-------|--------------------|
| 2095 | CRANE style |
| 2096 | Regular |
| 2097 | Recessed AM-STD |
| 2098 | CRANE red recessed |

TOILET SEAT BOLTS

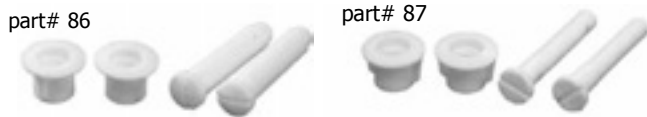

- Plastic toilet seat bolt sets, 2 sizes available
- 1 pair per hang bag or bulk packaging available

| PART# | DESCRIPTION |
|-------|-----------------------|
| 86 | 7/16" x 2-1/4" |
| 86Q | 7/16" x 2-1/4" - bulk |
| 87 | 3/8" x 2-3/8" |
| 87Q | 3/8" x 2-3/8" - bulk |

TOILET SEAT STABILIZERS



- Stops loose, twisting and wobbling toilet seats
- Tighten once and never again
- Works with all seats and hinges

| PART# | DESCRIPTION |
|-------|-----------------|
| 912 | Retail bag of 6 |
| 912Q | Bulk bag of 50 |

CAP - PLASTIC BOLT - ROUND



- Bottom snap washer included
- Available in package pair or poly bagged bulk

| PART# | DESCRIPTION |
|-------|--------------|
| 913 | White |
| 913Q | White - bulk |
| 914 | Bone |
| 914Q | Bone - bulk |

TOILET REPAIR

TOILET REPAIR

TANK LEVER - VINTAGE



- Solid cast brass construction
- Premier finish
- Made to match most faucets & stop handles
- Fits most water closet mechanism

| PART# | DESCRIPTION |
|-------------|----------------|
| 1070 | Straight lever |
| 1071 | 45° lever |

TANK LEVER - ACTUATOR HANDLE - AM-STD



- For ROMA toilets series 1012
- Die cast metal handle
- Plastic arm

| PART# | DESCRIPTION |
|-------------|-------------------------|
| 1078 | AM-STD push button 1012 |

TANK LEVER - SHORT 4" AM-STD



- 4" ABS plastic arm
- ABS handle
- Chrome, white, grey or bone

| PART# | DESCRIPTION |
|---------------|---------------|
| 1046 | Chrome |
| 1046W | White |
| 1046G | Grey |
| 1046B | Bone |
| 1046Q | Chrome - bulk |
| 1046WQ | White - bulk |
| 1046GQ | Grey - bulk |
| 1046BQ | Bone - bulk |

TANK LEVERS

TANK LEVER - MED 6" AM-STD



- 6" ABS plastic arm
- ABS handle chrome or white

| PART# | DESCRIPTION |
|---------------|---------------|
| 1066 | Chrome |
| 1066W | White |
| 1066Q | Chrome - bulk |
| 1066WQ | White - bulk |

TANK LEVER - 28° FIT ALL - AM-STD



- 4 to 6" adjustable arm in chrome, white, grey and bone
- ABS plastic
- 28° tank lever, fit all

| PART# | DESCRIPTION |
|---------------|---------------|
| 1067 | Chrome |
| 1067Q | Chrome - bulk |
| 1067W | White |
| 1067WQ | White - bulk |
| 1067G | Grey |
| 1067GQ | Grey - bulk |
| 1067B | Bone |
| 1067BQ | Bone - bulk |

TANK LEVER - 45° FIT-ALL - AM-STD



- 4 to 6" adjustable arm in chrome, white, grey and bone
- ABS plastic

| PART# | DESCRIPTION |
|---------------|-----------------------|
| 1063 | Chrome |
| 1063Q | Chrome - bulk |
| 1063PB | Polished brass handle |
| 1063W | White |
| 1063WQ | White - bulk |
| 1063G | Grey |
| 1063GQ | Grey - bulk |
| 1063B | Bone |
| 1063BQ | Bone - bulk |

TANK LEVER, LONG UNIVERSAL



- Fits CRANE, AM-STD, and others
- 8" ABS plastic arm
- ABS handle

| PART# | DESCRIPTION |
|---------------|---------------|
| 1047 | Chrome |
| 1047Q | Chrome - bulk |
| 1047W | White |
| 1047WQ | White - bulk |

TANK LEVERS

TANK LEVER - ABS HANDLE - BRASS ARM - AM-STD

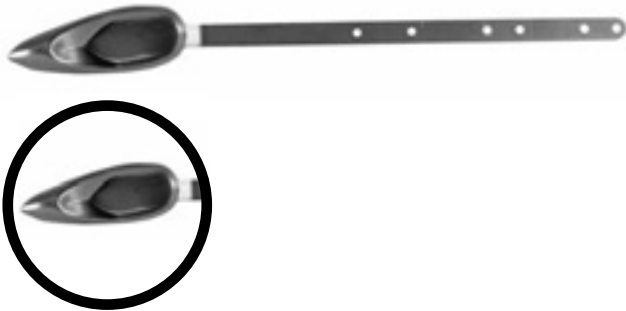

- Chrome and white available
- Plastic head AM-STD style
- Adjustable and bendable 8" brass arm

| PART# | DESCRIPTION |
|---------------|---------------|
| 1052 | Chrome |
| 1052Q | Chrome - bulk |
| 1052W | White |
| 1052WQ | White - bulk |

TANK LEVER - ABS HANDLE - BRASS ARM - AM-STD NEW STYLE



- AM-STD new style handle
- Chrome and White handle available
- Adjustable and bendable 8" brass arm

| PART# | DESCRIPTION |
|---------------|------------------------------------|
| 1057 | Universal tank lever - chrome |
| 1057W | Universal tank lever - white |
| 1057WQ | Universal tank lever - white bulk |
| 1057Q | Universal tank lever - chrome bulk |

TANK LEVER - AM-STD NEW STYLE HANDLE



- Chrome, white and bone handle available
- Plastic arm for 4", 6" and 8" lengths

| PART# | DESCRIPTION |
|---------------|---------------|
| 1053 | Chrome |
| 1053Q | Chrome - bulk |
| 1053W | White |
| 1053WQ | White - bulk |
| 1053B | Bone |
| 1053BQ | Bone - bulk |

TANK LEVER - AM-STD NEW STYLE HANDLE 28°



- Chrome, white and bone handle
- Plastic arm for 4" and 6" lengths available
- 28° arm

| PART# | DESCRIPTION |
|---------------|---------------|
| 1081 | Chrome |
| 1081Q | Chrome - bulk |
| 1081W | White |
| 1081WQ | White - bulk |
| 1081B | Bone |
| 1081BQ | Bone - bulk |

TOILET REPAIR

TANK LEVER - AM-STD NEW STYLE HANDLE, 45°



- Chrome, white and bone handle available
- Plastic arm for 4" and 6" lengths
- 45° arm

| PART# | DESCRIPTION |
|--------|---------------|
| 1082 | Chrome |
| 1082Q | Chrome - bulk |
| 1082W | White |
| 1082WQ | White - bulk |
| 1082B | Bone |
| 1082BQ | Bone - bulk |

TANK LEVER - ELJER



- 10" brass arm
- Die cast handle
- Plastic spud
- Plastic locknut
- Side mount

| PART# | DESCRIPTION |
|-------|-----------------------|
| 1049 | Chrome |
| 1049Q | Chrome - bulk |
| 1050 | Polished brass handle |

TANK LEVER - PUSH BUTTON AM-STD

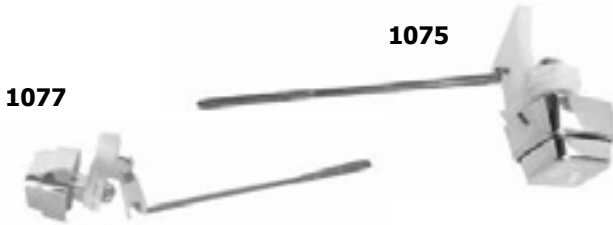

- Chrome plastic handle
- AM-STD, CRANE, KOHLER, ELJER
- Chrome finish
- Brass arm

| PART# | DESCRIPTION |
|-------|-------------------|
| 1075 | Front push button |
| 1077 | Side push button |

TANK LEVER - WELLWORTH II KOHLER



- 8" Plastic arm
- Die cast handle, chrome
- Plastic spud
- Plastic locknut
- OEM ref#9386

| PART# | DESCRIPTION |
|-------|---------------|
| 1051 | Chrome |
| 1051Q | Chrome - bulk |

TOILET REPAIR

TANK LEVER - KOHLER SIDE MOUNT



- Brass handle in chrome, nickel, or oil rubbed bronze finishes
- Brass arm 7" long
- Can be used on MEMOIRS and DEVONSHIRE toilets
- For 2 piece toilets, side mount installation
- OEM ref#9439

| PART# | DESCRIPTION |
|----------------|-------------------|
| 1083 | Chrome |
| 1083BN | Brushed nickel |
| 1083ORB | Oil rubbed bronze |

TANK LEVER - KOHLER FRONT MOUNT



- Brass handle in chrome, nickel, or oil rubbed bronze finishes
- Brass arm 7" long
- Can be used on DEVONSHIRE toilets
- For 1 piece toilets, front mount installation
- OEM ref#9462

| PART# | DESCRIPTION |
|----------------|-------------------|
| 1084 | Chrome |
| 1084BN | Brushed nickel |
| 1084ORB | Oil rubbed bronze |

TANK LEVER - KOHLER FRONT MOUNT



- Brass handle in chrome, nickel, or oil rubbed bronze finishes
- Brass arm 6" long
- Can be used on CIMMERON toilets
- Left side, front mount installation
- OEM ref#9466

| PART# | DESCRIPTION |
|----------------|-------------------|
| 1085 | Chrome |
| 1085BN | Brushed nickel |
| 1085ORB | Oil rubbed bronze |

TANK LEVER - KOHLER SIDE MOUNT



- Handle in chrome, nickel, or oil rubbed bronze finishes
- Brass arm 7" long
- Can be used on GABRILLE, SAN RAPHA and other toilets
- Side mount installation
- OEM ref#9464

| PART# | DESCRIPTION |
|----------------|-------------------|
| 1086 | Chrome |
| 1086BN | Brushed nickel |
| 1086ORB | Oil rubbed bronze |

TANK LEVERS

TANK LEVER - TOTO

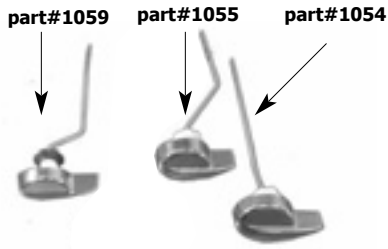

- 10" round brass arm
- CP Die cast handle (part# 1059 only)
- Plastic spud CP plastic handle
- Plastic locknut
- Side mount

| PART# | HANDLE MATERIAL | DESCRIPTION |
|-------|-----------------|-------------|
| 1059 | Metal | TOTO THU068 |
| 1054 | Plastic | TOTO THU004 |
| 1055 | Plastic | TOTO THU061 |

TANK LEVER - MANSFIELD



- Front mount tank lever
- Chrome handle, ABS
- Plastic 9" arm

| PART# | DESCRIPTION |
|-------|----------------------------------|
| 1045 | #41 & #42 New style C.P. plastic |

TANK LEVER - MANSFIELD



- Old style lever
- Front mount handle, die cast metal
- Brass 10" arm

| PART# | DESCRIPTION |
|-------|--|
| 1065 | #42 CP die cast handle, metal arm, old style |

TANK LEVER - UNIVERSAL

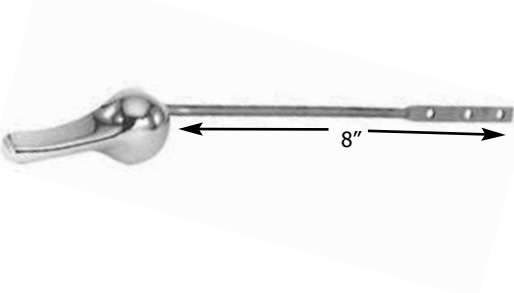

- LYNCAR'S most popular universal lever
- Die cast metal handle, chrome
- Brass arm 8"

| PART# | DESCRIPTION |
|--------|-------------------------------------|
| 1040 | Chrome - die cast spud & nut |
| 1040Q | Chrome - die cast spud & nut - bulk |
| 1040PB | Polished brass handle |

TANK LEVER - UNIVERSAL PREMIUM

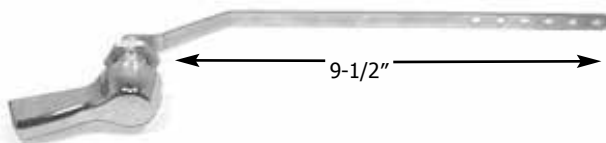

- Universal premium lever
- Die cast metal handle, chrome
- Brass arm 9-1/2" offset

| PART# | DESCRIPTION |
|-------|---------------------------|
| 1056 | Offset premium tank lever |

TANK LEVERS

C

TANK LEVER - OFFSET WESTERN POTTERY



| PART# | DESCRIPTION |
|-------|----------------------------|
| 1058 | WESTERN POTTERY tank lever |

TANK LEVER - SURE-FIT FLUIDMASTER



- 8" ABS plastic arm
- ABS plastic handle
- Retail carded

| PART# | DESCRIPTION |
|-------|----------------------|
| FM680 | White #680C |
| FM681 | Chrome #681C |
| FM682 | Polished Brass #682C |

PUSH-BUTTON TANK LEVERS



- Especially for side-mount tanks
- Easy to install
- Fits most AM-STD and UNIVERSAL-RUNDLE® brand toilets
- Available in Chrome Only

| PART# | DESCRIPTION |
|-------|-------------------------|
| FM691 | Push-Button tank levers |

TOILET REPAIR

FLAPPERS

ACTUATOR FOR AMERICAN STANDARD



| PART# | REPLACES AMSTD | DESCRIPTION |
|-------|---|--------------|
| 1038 | #5 | Low profile |
| 1039 | #6 | High profile |
| 1042 | Repair kit with chain rubber grommet & clip | |

ADJUSTABLE FLAPPER FOR AMERICAN STANDARD



- Colour coded timed tips
- For a variety of flush rates

| PART# | BULK PART# |
|-------|------------|
| 10143 | 10143Q |

BLACK RUBBER FLAPPER AMERICAN STANDARD



- Premium rubber flapper
- Fits AM-STD toilets, CADET, PLEBE & others
- Steel chain

| PART# | BULK PART# |
|-------|------------|
| 1003 | 1003Q |

3 WAY WITH FLOAT FOR AMERICAN STANDARD



- 9" chrome plated brass chain
- Vinyl flapper with float
- OEM ref#738003-300

| PART# | BULK PART# |
|-------|------------|
| 10142 | 10142Q |

FLAPPER - FOR AMERICAN STANDARD ACTUATOR



| PART# | BULK PART# | DESCRIPTION |
|-------|------------|---------------|
| 1035 | 1035Q | Combo Fit-All |
| 1036 | 1036Q | Screw-On |
| 1037 | 1037Q | Snap-On |







FLAPPER - AMERICAN STANDARD



- Oversized plastic flapper
- For CADET III
- Chemical resistant
- OEM ref#738920-007A

| PART# | BULK PART# |
|-------|------------|
| 1043 | 1043Q |

FLAPPERS

| FLAPPER - KORKY FOR AM-STD | | FLAPPER - CRANE NEW STYLE | |
|---|--------------------------|---|-------------------|
|  <ul style="list-style-type: none"> - Replaces AM-STD No. 738920-0070P - Five year guarantee, chlorine resistant | |  <ul style="list-style-type: none"> - Premium rubber flapper - Stainless steel chain - Universal fit | |
| PART# | DESCRIPTION | PART# | BULK PART# |
| 3040BP | KORKY flapper for AM-STD | 1005 | 1005Q |
| FLAPPER - OLD STYLE CRANE | | COAST STYLE "BLUE" FLAPPER | |
|  <ul style="list-style-type: none"> - Stainless steel chain - Polystyrene float | |  <ul style="list-style-type: none"> - The popular copy of the COAST style blue flapper - Chemical resistant and is widely accepted in the industry | |
| PART# | BULK PART# | PART# | BULK PART# |
| 1004 | 1004Q | 10141 | 10141Q |
| COASTMASTER "BLUE" FLAPPER | | COASTMASTER "BLUE" FLAPPER WITH CHAIN | |
|  <ul style="list-style-type: none"> - COASTMASTER'S popular blue flapper - Chemical resistant and is widely accepted in the industry | |  <ul style="list-style-type: none"> - COASTMASTER'S popular blue flapper - Chemical resistant and is widely accepted in the industry - Supplied with steel chain | |
| PART# | BULK PART# | PART# | BULK PART# |
| 10090 | 10090Q | 10092 | 10092Q |

FLAPPERS

COASTMASTER "CERTAIN SEAL" FLAPPER



- Hard plastic flapper
- Stainless steel chain
- Pressure sensitive seal
- Fits AM-STD, KOHLER, TOTO
- CSA approved

| PART# | DESCRIPTION |
|--------------|--------------|
| 53316 | Certain seal |

FLAPPER ELJER



- White plastic
- Stainless steel chain
- Fits ELJER - LOW BOY, WINDSOR, CANTERBURY
- Styrofoam ball

| PART# | DESCRIPTION |
|--------------|---------------|
| 11345 | ELJER plastic |

TITAN FLAPPER, RED ELJER



- TITAN model
- Chlorine resistant
- KORKY design
- Replaces ELJER 495-6077-00

| PART# | DESCRIPTION |
|--------------|-------------------|
| 10151 | TITAN Red Flapper |

TITAN FLAPPER, BLUE ELJER



- Blue
- Stainless steel chain
- Extra large flapper
- Replaces ELJER 495-6077-00

| PART# | DESCRIPTION |
|--------------|--------------------|
| 10119 | TITAN blue flapper |

FLAPPER FRUGAL



Adjust - a - dial

- Designed to convert 3.6, 5 and 7 gallon per flush toilets into water saving toilets by reducing the amount of water per flush by 30 to 50%
- Adjustable water saving
- Fits most 3.5 gallon toilets

| PART# | DESCRIPTION |
|-------------|--------------|
| 1022 | Box packaged |

MANSFIELD FLAPPER



- Blue, oversized
- Stainless steel chain
- OEM ref#630-0206

| PART# | DESCRIPTION |
|--------------|---------------------|
| 10122 | Extra large flapper |

FLAPPERS

TOILET REPAIR

FLAPPER - RUBBER KOHLER



- 8" chain
- Resistant to tank bowl cleaners
- Replaces KOHLER #49114

FLAPPER - KOHLER CIMMERON STYLE



- Red
- Stainless steel chain
- Extra large flapper

PART# DESCRIPTION

- 1031** LYNCAR black
- 1031Q** LYNCAR black - bulk
- 10154** KORKY red

PART# DESCRIPTION

- 10120** KORKY KOHLER Cimmeron

KOHLER CLASS 5 STYLE FLAPPER



- Red
- Stainless steel chain
- Extra large flapper

KORKY 2010 FITS KOHLER RIALTO FLAPPER



- Fits specific KOHLER one-piece toilets
- Premium red Chlorazone rubber resists chlorine
- Embedded styrofoam float
- Replaces KOHLER #83064

PART# DESCRIPTION

- 10158** Red KORKY model, Class 5
- 10121** Red LYNCAR model, Class 5

PART# DESCRIPTION

- 10155** KORKY KOHLER

KORKY 2011 FITS KOHLER HINGE FLAPPER



- Fits specific KOHLER one-piece toilets
- Premium red Chlorazone rubber resists chlorine
- Flapper hinges onto back of flush valve
- Replaces KOHLER #84995 & #1000490

KORKY 2010 FITS KOHLER SHARK FIN FLAPPER



- Fits specific KOHLER one-piece toilets
- Premium red Chlorazone rubber
- Resists chlorine
- Replaces KOHLER #84318, #84314, #85655 and #89825

PART# DESCRIPTION

- 10156** KORKY KOHLER Hinge

PART# DESCRIPTION

- 10157** KORKY KOHLER Shark Fin

FLAPPERS

KORKY FLAPPER - 54



- Blister packed
- Preferred by plumbers for superior quality and reliability since 1954
- Universal replacement flapper

PART# DESCRIPTION

54 KORKY 54

KORKY PLUS FLAPPER - 2001



- Chlorazone red rubber
- Resists chlorine
- Universal design fits both brass and plastic flush valves

PART# DESCRIPTION

55 KORKY 2001

KORKY PLUS 6L FLAPPER 16



- Premium red Chlorazone rubber
- Designed for newer (since 1995) 1.6 gallon toilets
- Resists chlorine
- Saves up to 50% more water in standard toilets (older than 1995)
- Five year guarantee

PART# DESCRIPTION

16 KORKY 6L Flapper

KORKY PLUS ADJUSTABLE TOILET TANK FLAPPER



- Made from Chlorazone
- Easily adjusts to save water or a bigger flush
- Fits most brands
- 5 year guarantee

PART# DESCRIPTION

51 KORKY PLUS

KORKY CLASSIC



- Original design for brass flush valves
- For older, 5 and 7 g.p.f. toilets
- Also available in premium red Chlorazone rubber

PART# DESCRIPTION

50 KORKY CLASSIC

KORKY MAXFLUSH



- Fits slanted plastic flush valves
- Stays open longer for maximum flush
- Specially designed for low boy style toilets

PART# DESCRIPTION

92 KORKY MAXFLUSH

FLAPPERS

TOILET REPAIR

KORKY® 525BP FLAPPER



- Made of durable vinyl
- Easy to install, prevents leaks
- Fits most two piece toilets
- Tangle free lift strap
- Fits CRANE brass and plastic flush valves

KORKY CLASSIC CHLORAZONE



- Premium red Chlorazone rubber
- Original design for brass flush valves
- For older, 5 and 7 g.p.f. toilets

| PART# | DESCRIPTION |
|--------------|-------------------|
| 10126 | KORKY 525 flapper |

| PART# | DESCRIPTION |
|-------------|---------------------------------------|
| 50CR | KORKY CLASSIC, Chlorazone red, 2000BP |

FITS TOTO® G-MAX™ FLAPPER



- Authorized replacement flapper for TOTO G-MAX toilets, or Non OEM models
- 3" sealing surface for larger TOTO flush valve seats
- Red in colour
- Resists chlorine
- Five year guarantee
- Non OEM model also available

TOTO® - POWER GRAVITY



- Authorized replacement flapper for TOTO power gravity toilets, or Non OEM models
- 3" sealing surface for larger TOTO flush valve seats
- Blue in colour
- Resists chlorine
- Five year guarantee
- Non OEM model also available

| PART# | DESCRIPTION |
|--------------|-------------|
| 10131 | KORKY OEM |

| PART# | DESCRIPTION |
|--------------|-------------|
| 10130 | KORKY OEM |

KOHLER TANK TO BOWL GASKET



- Fits most 2 pc KOHLER toilets
- Includes 3 brass bolts with washers and nuts
- KOHLER triangle gasket
- OEM ref#51487

KORKY® LARGE 3 INCH ADJUSTABLE FLAPPER



- Adjusts to fit all 3 inch toilets
- Universal design fits large 3 inch flush valves
- Adjusts to match performance of OEM flapper
- Five year guarantee

| PART# | DESCRIPTION |
|-------------|---------------|
| 3001 | KOHLER gasket |

| PART# | DESCRIPTION |
|---------------|--------------------------|
| 3060BP | Universal 3" fit flapper |

UNIVERSAL FLAPPERS

FITS TOTO® G-MAX™ FLAPPER



- 3" sealing surface for larger TOTO flush valve seats
- Red in colour
- Resists chlorine
- Five year guarantee

TOTO® - POWER GRAVITY



- 3" sealing surface for larger TOTO flush valve seats
- Blue in colour
- Resists chlorine
- Five year guarantee

| PART# | DESCRIPTION |
|-------|-----------------------|
| 10124 | Non OEM, LYNCAR brand |

| PART# | DESCRIPTION |
|-------|-----------------------|
| 10123 | Non OEM, LYNCAR brand |

PLASTIC ADJUSTABLE



- Adjustable flapper
- Blue plastic body
- Seal washer
- Steel chain
- Fits AM-STD/ KOHLER/ TOTO

UNIVERSAL RUBBER FLAPPER



- Premium grade rubber
- Universal
- Steel chain

| PART# | DESCRIPTION |
|-------|----------------------------|
| 10140 | Plastic adjustable flapper |

| PART# | BULK PART# |
|-------|------------|
| 1028 | 1028Q |

TANK BALL



- Water saver
- 1 per box

UNIVERSAL VINYL FLAPPER



- Vinyl flapper
- Universal
- Steel chain

| PART# | DESCRIPTION |
|-------|-------------|
| 1032 | Tank Ball |

| PART# | BULK PART# |
|-------|------------|
| 10144 | 10144Q |

FLUSH VALVES

FLUSH VALVE - DOUGLAS, BRASS



- Rubber washer
- Solid ring guide
- Locknut overflow tube

| PART# | DESCRIPTION |
|-------|----------------------------------|
| 1027 | Brass flush valve with brass nut |

FLUSH VALVE - DOUGLAS, PLASTIC



- White plastic
- Steel chain
- Rubber flapper
- Valve gasket
- Fits AM-STD / CRANE and others

| PART# | DESCRIPTION |
|-------|----------------------------|
| 1029 | Flush valve plastic |
| 1029Q | Flush valve plastic - bulk |

MANSFIELD # 210/211 STYLE FLUSH VALVE



- For 3.5 gallon tank
- 10-3/4" length

| PART# | DESCRIPTION |
|-------|------------------------------|
| 10210 | Full flush |
| 10211 | Water saver 1.6 gallon flush |

FLUSH VALVE ADJUSTABLE



- Adjustable overflow tube
- Adjusts from 6" to 11"
- Rubber flapper
- Fits AM-STD / KOHLER / ELJER / CRANE and others

| PART# | DESCRIPTION |
|--------|-------------------------------|
| 10299 | Flush valve adjustable |
| 10299Q | Flush valve adjustable - bulk |

TOILET REPAIR

FLUSH VALVE 2" ABS



- Flapper flush valve 2"
- ABS material, premium quality
- Adjustable overflow tube
- ABS flapper with silicone seal
- cUPC approved

| PART# | DESCRIPTION |
|-------|--------------------|
| 1020 | Flush valve |
| 1020Q | Flush valve - bulk |

FLUSH VALVE 3" ABS



- Flapper flush valve 3"
- ABS material, premium quality
- Adjustable overflow tube
- ABS flapper with silicone seal
- cUPC approved

| PART# | DESCRIPTION |
|-------|--------------------|
| 1021 | Flush valve |
| 1021Q | Flush valve - bulk |

KORKY 2" TOP MOUNT FLUSH VALVE #723X



- With flapper for 1 pc toilets
- Fits 2" one-piece toilets, including AMERICAN STANDARD®
- 7.5" overflow tube height
- Easy to install (installation driver included)
- Engineered materials resist chlorine
- Five year guarantee
- cUPC approved

| PART# | DESCRIPTION |
|-------|-------------|
| 10145 | Flush valve |

FLUSH VALVE CONVERTER



- Converts older 1.6 gpf toilets to a powerful 3" flush
- Telescoping overflow tube
- KOHLER Class 5 flapper
- Flush valve seal, nut, and recessed sponge gasket
- Tank to bowl balancing washers
- Replace most popular 2" flush valves

| PART# | DESCRIPTION |
|-------|-----------------------|
| 1016 | Flush valve converter |

FAUCET REPAIR

MINI PILOT BALLCOCK



- Anti-siphon
- One piece design
- No need for rod or float
- Refill tube, nut & washers included
- Operates below water level

| PART# | DESCRIPTION |
|--------------|------------------------------|
| 10093 | Replaces old style ballcocks |

DUAL FLUSH TOILET KIT



- Easy to install
- Fits most front and side
- Save water on every flush
- Push button dual flush
- cUPC approved

| PART# | DESCRIPTION |
|--------------|-----------------------|
| 10078 | Dual flush toilet kit |

FILL & DUAL FLUSH VALVE



- Converts your existing toilet to Dual Flush Technology
- Uses up to 45% less water
- Automatically save water and delivers precise and powerful flushing action
- Fully adjustable for a wide range of applications
- Complete system included

| PART# | DESCRIPTION |
|----------------|----------------------------|
| FMS2DBL | FLUIDMASTER Dual Flush Kit |

TOTO REPLACEMENT FILL VALVE FROM KORKY



- Proven quietest
- 5 year guarantee
- OEM for TOTO
- Easiest to install... No tools required!
- Resists chemicals and toilet tank cleaners
- Retail Packaged
- Replaces TOTO Power Gravity & G-Max Fill Valves
- CSA approved

| PART# | DESCRIPTION |
|--------------|------------------|
| 10129 | #528T Fill valve |

TOILET REPAIR

TOILET REPAIR

KORKY® QUIETFILL FILL VALVE



- Proven quietest
- 5 year guarantee
- Fits all brands
- Easiest to install... No tools required!
- Resists chemicals and toilet tank cleaners

| PART# | DESCRIPTION |
|-------|----------------------------|
| 10125 | #528CF QUIETFILL |
| 10127 | Repair Kit #528CF BALLCOCK |

KORKY® UNIVERSAL TOILET REPAIR KIT



- Fix your leaking, noisy, or running toilet in 1 trip
- Kit includes: fill valve, flush valve, KORKY PLUS flapper, tank-to-bowl gasket, nuts, bolts and washers

| PART# | DESCRIPTION |
|-------|-------------------|
| 10133 | Toilet repair kit |

KORKY® ADJUSTABLE FLUSH VALVE & FLAPPER



- Universal design, fits most 2 piece toilet tanks
- Height easily adjusts from 7" to 11-1/2"
- Oversized tube and funnel reduce flood risk

| PART# | DESCRIPTION |
|-------|-------------------|
| 10132 | KORKY flush valve |

FLUIDMASTER BALLCOCKS

TOILET REPAIR

400A



- Anti-siphon ballcock
- Adjustable 9" to 14"
- Retail packaged
- CSA approved OEM

400LS



- Leak sentry ballcock
- Prevent endless, automatic refilling of leaky tanks.
- Adjustable 9" to 14"
- Retail packaged
- CSA approved

| PART# | DESCRIPTION |
|---------------|----------------------|
| FM400A | Anti-siphon ballcock |

| PART# | DESCRIPTION |
|----------------|----------------------|
| FM400LS | Leak sentry ballcock |

400C



- All you need in one kit to fix the most common leaks and squeaks
- Features the proven 400A Fill Valve and the rugged BULL'S EYE® Super Flapper (501)
- Flapper is chlorine-resistant for harsh water regions
- CSA approved

BULLS EYE FLAPPER



- Basic repair for average conditions
- Replaces old tank ball or worn flapper
- Easy to install, fits most tanks
- Hinged to a rigid frame for better alignment

| PART# | DESCRIPTION |
|---------------|----------------------------|
| FM400C | 400C ballcock with flapper |

| PART# | DESCRIPTION |
|--------------|------------------|
| FM500 | Bullseye flapper |

FLUSHER FIXER KIT



- Includes new drain seat for repairing older, corroded tank drains
- Fits most tanks
- Adjustable timing cup for most efficient flush
- Chlorine-resistant flapper for harsh water regions
- Five-Year Warranty

MANSFIELD FLUSH VALVE SEAL



- Seal for # 210 / 211 MANSFIELD
- Flush Valve

| PART# | DESCRIPTION |
|---------------|-------------------|
| FM555C | Flusher fixer kit |

| PART# | DESCRIPTION |
|--------------|----------------------------|
| 10212 | MANSFIELD flush valve seal |

TOILET REPAIR

COAST 1B1 STYLE 10" FILL VALVE



- One piece design
- Rod, refill tube, nut & washers included
- OEM ref#12114
- CSA approved



| PART# | DESCRIPTION |
|-------|-------------|
|-------|-------------|

| | |
|-------|----------------|
| 10213 | 10" fill valve |
|-------|----------------|

COAST 1B1X STYLE FILL VALVE



- Fits most one piece toilets
- Retail packaged
- One piece design
- Rod, refill tube, nut & washers included
- OEM ref#10174
- CSA approved



| PART# | DESCRIPTION |
|-------|-------------|
|-------|-------------|

| | |
|-------|-----------------------|
| 10214 | 1B1X style fill valve |
|-------|-----------------------|

1B1X CONVERSION KIT, FOR KOHLER TOILETS



- Conversion kit for KOHLER using a COASTMASTER or COAST 1B1X ballcock (not included)
- For one piece toilets
- Includes front rim diverter and tube
- For use with LynCar **part#10214 (above)** or COASTMASTER 10084X (OEM) (**page C-24**)
- Compare to KOHLER OEM ref#84499

| PART# | DESCRIPTION |
|-------|-------------|
|-------|-------------|

| | |
|-------|---------------------|
| 10230 | Conversion kit only |
|-------|---------------------|

| | |
|-------|--|
| 10231 | Kit with LYNCAR part#10214 COAST 1B1X fill valve (page C-22) |
|-------|--|

| | |
|-------|---|
| 10232 | Kit with COASTMASTER (OEM) 1B1X fill valve (page C-24) |
|-------|---|

MANSFIELD STYLE 10" FILL VALVE



- One piece design
- Rod, refill tube, nut & washers included
- OEM ref#07
- CSA approved



| PART# | DESCRIPTION |
|-------|-------------|
|-------|-------------|

| | |
|-------|----------------|
| 10215 | 10" fill valve |
|-------|----------------|

HOOVER STYLE ANTI-SIPHON BALLCOCK



- Reliable
- Quiet operation
- CSA approved



| PART# | DESCRIPTION |
|-------|-------------|
|-------|-------------|

| | |
|-------|--|
| 10082 | 8-1/2" ballcock complete w/ float rod , "s" clip, tube , CSA |
|-------|--|

| | |
|-------|---|
| 10102 | 10" ballcock complete w/ float rod, "s" clip, tube, CSA |
|-------|---|

| | |
|-------|--|
| 10112 | 12" ballcock complete w/ float rod, "s" clip, tube |
|-------|--|

| | |
|-------|---|
| 10079 | 9" - 13" adjustable hoover style ballcock |
|-------|---|

TOILET REPAIR

TOILET REPAIR

COASTMASTER 1B1 FILL VALVE



- Retail packaged
- One piece design
- Rod, refill tube, nut & washers included
- **Part#10084** OEM ref#12114
- **Part#10085** OEM ref#12164
- CSA approved

| PART# | DESCRIPTION |
|--------------|-------------|
| 10084 | 10" |
| 10085 | 12" |

COASTMASTER FIT ALL FILL VALVE



- Retail packaged
- One size fits all tanks
- Rod, refill tube, nut & washers included
- OEM ref#12704
- CSA approved

| PART# | DESCRIPTION |
|--------------|-------------|
| 10086 | FIT ALL |

COASTMASTER MARK IV FILL VALVE



- Retail packaged
- One piece design
- Rod, refill tube, nut & washers included
- OEM ref#13364
- CSA approved

| PART# | DESCRIPTION |
|--------------|-------------|
| 10087 | 12" |

LYNCAR'S ANTI-SIPHON FILL VALVE



- Universal replacement fill valve
- Quiet design
- Height adjustable 8" to 13"
- Colour display box packaged
- cUPC and ASSE approved

| PART# | DESCRIPTION |
|--------------|------------------------------|
| 10400 | Adjustable anti-siphon valve |

BALLCOCKS & TANK REPAIR PARTS

COASTMASTER 1B1 ADJUSTABLE



- Retail packaged
- 9-1/2" to 13"
- One piece design
- Rod, refill tube, nut & washers included
- OEM ref#14044
- CSA approved

| PART# | DESCRIPTION |
|-------|-------------|
| 10088 | FIT ALL |

COASTMASTER 1B1X FILL VALVE



- Fits most one piece toilets
- Retail packaged
- One piece design
- Rod, refill tube, nut & washers included
- OEM ref#10174
- CSA approved

| PART# | DESCRIPTION |
|---------|--|
| 10084X | 1B1X fill valve |
| 10084XT | Top only replacement for 1B1X fill valve |

COASTMASTER 1B1 REPAIR KIT



10088RK



10084XRK



10084XTA

- Repair kits include: one seal ring, one complete piston assembly
- Top assembly includes screws

| PART# | DESCRIPTION |
|----------|---------------------|
| 10088RK | For 1B1 fill valve |
| 10084XRK | For 1B1X fill valve |
| 10084XTA | 1B1X top assembly |

TOILET REPAIR

TANK LIDS - HIGH IMPACT PLASTIC



- LYNCAR'S replacement toilet tank lids are an inexpensive way to replace a lost or broken lid
- White in colour and can be painted to match any coloured toilet
- Individually boxed

| PART# | DESCRIPTION | SIZE |
|-------|---------------|------------------|
| 10223 | Universal Fit | 22-3/4" x 8-3/4" |

TOILET COVER SHOE



- White plastic 13" x 23-1/2" overall size
- Caulk & seal design, fits all toilets including round & square front toilets
- Use when converting to low flush toilet from full flush
- Saves replacing the floor tiles
- Covers unsightly stains from old toilet base
- 13" x 23-1/2"

| PART# | DESCRIPTION |
|-------|----------------------------|
| 1012 | 1.6 conversion cover plate |

SLOAN FLUSHMATE STYLE CARTRIDGE

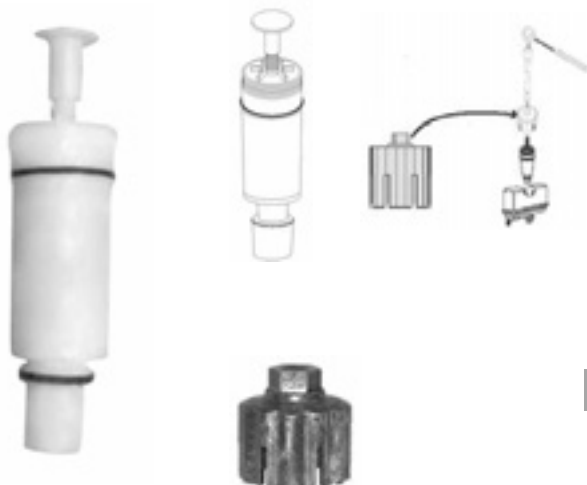

- Quality non-OEM replacement
- Fits all FLUSHMATE 2 piece toilets
- American manufactured
- Bagged with instructions
- 100% individually tested
- FLUSHMATE cartridge OEM ref# C100500K
- Easy out tool OEM ref# ST1500

| PART# | DESCRIPTION |
|-------|---------------------|
| 10137 | FLUSHMATE cartridge |
| 10138 | Easy out tool |

TOILET REPAIR

TOILET STABILIZER SHIMS



- Available in soft or hard plastic
- 1-1/4" x 2" to 1/4" thick

| PART# | DESCRIPTION |
|--------------|-------------------------------|
| 234 | 10 per bag - standard (soft) |
| 234Q | 100 per bag - standard (soft) |
| 234H | 10 per bag - standard (hard) |
| 234HQ | 100 per bag - standard (hard) |

BALLCOCK REPAIR PARTS



10081 2099 1015N

| PART# | DESCRIPTION |
|--------------|---|
| 1015N | (New Style) bonnet, arm , diaphragm & screw |
| 1017 | Plastic refill tube |
| 10081 | "S" clip for refill tube (100 per package) |
| 2099 | Rubber shank washer |

TANK OVERFLOW TUBE - BRASS



- 10" Brass tube
- Fine thread, one end

| PART# | DESCRIPTION |
|------------|-------------|
| 870 | 1" x 10" |

BALLCOCK COUPLING NUT



| PART# | DESCRIPTION |
|-------------|-------------|
| 1320 | Plastic |
| 1321 | Brass |

TANK FLOAT RODS - BRASS



- 20 TPI
- # 882 8" most popular

| PART# | DESCRIPTION |
|------------|-------------|
| 882 | 8" long |
| 883 | 9" long |
| 884 | 10" long |
| 886 | 12" long |

PLASTIC FLOATS



- Plastic 4" x 5" oval float

| PART# | DESCRIPTION |
|-------------|----------------|
| 1073 | Plastic floats |

TOILET REPAIR

WAX GASKET WITH HORN



- Premium made wax with horn
- For 3" or 4" closet rings
- Box packaged

WAX GASKET



- Premium made wax
- Box packaged

| PART# | DESCRIPTION |
|-------|----------------------|
| 270 | Wax gasket with horn |

| PART# | DESCRIPTION |
|-------|----------------------|
| 268 | Wax gasket less horn |

WAX GASKET JUMBO WITH HORN



- Supersized wax ring with horn
- Extra long horn
- Box packaged

LYNCAR MAXIMUM WAX GASKET WITH HORN

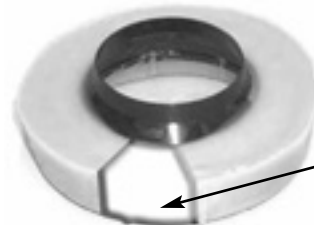

REINFORCED

- Felt reinforced wax ring with horn
- Forms a gas & water tight seal
- Maximum seal
- Professional Duty
- Box packaged

| PART# | DESCRIPTION |
|-------|----------------------|
| 272 | Flex-a-flange, jumbo |

| PART# | DESCRIPTION |
|-------|---------------------|
| 274 | Reinforced wax seal |

SPONGE RUBBER FLANGE GASKET



- Black
- 3-1/2" ID x 5-3/8" OD
- Resists mold, mildew and fungus

RED POLY FLANGE GASKET



- Red clay colour
- Made of Polyurethane foam

| PART# | DESCRIPTION |
|-------|-------------|
| 2229 | 1/2" thick |
| 2230 | 3/4" thick |
| 2228 | 1" thick |

| PART# | DESCRIPTION |
|-------|-------------|
| 2051 | 1/2" thick |
| 2052 | 3/4" thick |
| 2053 | 1" thick |

TOILET REPAIR

FLANGE EXTENSION KIT

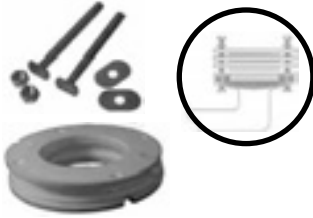

- Kit Contains:
3 Self-sealing extenders
With 1/4" x 3-1/2" closet bolts, nuts & washers

| PART# | DESCRIPTION |
|-------|----------------------|
| 1018K | Flange extension kit |

FLANGE EXTENSION RINGS



- 1/4" thick

| PART# | DESCRIPTION |
|-------|-------------|
| 1018 | Durable ABS |

4 HOLE PATTERN ABS TOILET FLOOR FLANGE



- Fits 3" inside pipe ABS or PVC
- WC cheater flange
- Made from ABS plastic

| PART# | DESCRIPTION |
|-------|-------------------------|
| 8024 | ABS toilet floor flange |

4 HOLE PATTERN BRASS FLOOR FLANGE



(Heavy Duty Shown)

| PART# | DESCRIPTION |
|-------|-----------------------------|
| 10134 | Light duty |
| 10135 | Medium duty |
| 10136 | Heavy duty reducing 4" x 3" |

FLANGE - CLOSET REPLACEMENT - 3"



- Compression o-ring joint
- Two o-ring diameters to accommodate different inside pipe diameters
- No need to remove lead joint, no tearing up floors
- No caulking lead joints
- Slides inside 3" cast iron
- Also fits Sch 30 and Sch 40 ABS & PVC
- Simply engage o-ring for snug fit, align bolt slots with proper toilet position and push into pipe for compression seal
- Secure flange to floor for proper installation

| PART# | DESCRIPTION |
|-------|---------------------------|
| 20020 | Flange Closet Replacement |

ADJUSTABLE ABS STREET FLANGE - 3"



- Fits inside 3" Sch 40 pipe
- Ideal for concrete construction
- Eliminate need for chipping and chiseling concrete
- Makes repair jobs faster and easier
- Has extended length to reach riser below floor height

| PART# | DESCRIPTION |
|-------|--|
| 20022 | Allowing up to 3" of adjustment to riser |

TOILET REPAIR

TOILET REPAIR

C

TOILET REPAIR

QUICK RING REPAIR FLANGES



- Unique screw tabs attach to wood or concrete
- Plastisol coat provides corrosion protection
- Slotted for 1/4" or 5/16" closet bolt
- Old closet ring does not need to be present
- Replaces any and all closet rings.
- For solvent welded steel / plastic combo and plastic closet rings
- Remove portion of broken ring, if remaining portion cannot be removed, Quick Ring will mount on top
- Apply a bead of butyl rubber caulk to the underside of the Quick Ring that will mount on top of the old ring
- Set Quick Ring on top of remaining portion of old ring
- Note location of old toilet bolt slots
- The length of the bolt slots in the Quick Ring allows for some centering of toilet. Secure the Quick Ring to wood or concrete sub floor with screws or anchors

| PART# | DESCRIPTION |
|-------|-----------------------------|
| 21013 | Quick ring flange WITH tabs |
| 21017 | Quick ring flange LESS tabs |

QUICK RING FIX FLANGE & HALF ANCHOR

part#21015



part#21014



- Eliminate the need to replace broken closet flanges, saving time and money. Simply place the flange under the broken area of the ring and tighten the nut
- Suitable for use with cast iron, plastic, copper and brass closet flanges
- Packaged for retail display

| PART# | DESCRIPTION |
|-------|-------------------------------|
| 21015 | Quick ring fix flange |
| 21014 | Quick ring half anchor flange |

TOILET REPAIR

PIPESNAP COVER



- Chrome plated plastic
- Splits open to wrap around copper or pex pipe
- Give you a chrome plated look
- Easy to cut to size needed
- 8" long strips

| PART# | DESCRIPTION |
|-------|-------------|
|-------|-------------|

| | |
|-------|---------------|
| 1273 | 5 pack carded |
| 1273Q | bulk 25 pack |

CHROME BRASS, COVER TUBE



- Chrome plated brass pipe
- Goes over copper / PEX pipe
- Gives you a Chrome brass finish
- 5/8 OD x 3-1/2" long

| PART# | DESCRIPTION |
|-------|-------------|
|-------|-------------|

| | |
|------|-------------------------|
| 8489 | Chrome brass cover tube |
|------|-------------------------|

QUICK RING FLOOR REPAIR PLATE

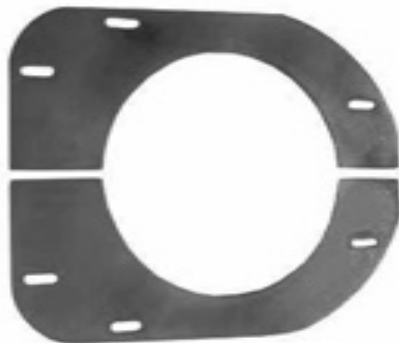

- Easy to use floor and flange support
- Extends the anchoring surface
- Hardware included
- 9-1/4" x 7-1/8" coverage under toilet
- Display packaged

| PART# | DESCRIPTION |
|-------|-------------|
|-------|-------------|

| | |
|-------|--------------------|
| 21016 | Floor repair plate |
|-------|--------------------|

SECTION "D" TOILET REPAIR INDEX

| | | | |
|--------------------------------|------|---|------|
| Aerator Gauge | D-49 | Handles - BELANGER | D-6 |
| Am/Std Handles & Cartridges | D-1 | Handles - CRANE | D-3 |
| BELANGER - Spouts | D-40 | Handles - CUTHBERT | D-6 |
| BELANGER - Handles | D-6 | Handles - DANFOSS | D-8 |
| Beveled Washer Kits | D-47 | Handles - DELTA | D-9 |
| Bibb Screws | D-48 | Handles - EMCO | D-15 |
| BRADLEY Handles & Cartridges | D-2 | Handles - Fit All | D-17 |
| Cartridges - Am/Std. | D-1 | Handles - GERBER | D-19 |
| Cartridges - BRADLEY | D-2 | Handles - JAMECO | D-20 |
| Cartridges - CHICAGO | D-2 | Handles - MIXET | D-21 |
| Cartridges - CUTHBERT | D-6 | Handles - MOEN | D-22 |
| Cartridges - DANFOSS | D-8 | Handles - POWERS CRANE | D-26 |
| Cartridges - DELTA | D-13 | Handles - PRICE PFISTER | D-27 |
| Cartridges - EMCO | D-15 | Handles - STERLING | D-30 |
| Cartridges - GALMASTER | D-18 | Handles - SYMMONS | D-32 |
| Cartridges - GERBER | D-19 | Handles - VALLEY | D-35 |
| Cartridges - JAMECO | D-20 | Handles - WALTEC | D-37 |
| Cartridges - MIXET | D-21 | JAMECO - Handles & Cartridges | D-20 |
| Cartridges - MOEN | D-22 | Kitchen Replacement Spouts | D-40 |
| Cartridges - MUELLER | D-25 | Kits - O - Rings | D-41 |
| Cartridges - PRICE PFISTER | D-28 | KORKY - Faucet Washers | D-46 |
| Cartridges - STERLING | D-31 | Laundry Handles & Cartridges EMCO | D-16 |
| Cartridges - SYMMONS | D-33 | MIXET - Handles & Cartridges | D-21 |
| Cartridges - T&S BRASS | D-34 | MOEN - Handles & Cartridges | D-22 |
| Cartridges - VALLEY | D-35 | MOEN - Clips | D-24 |
| Cartridges - WALLACEBURG | D-36 | MUELLER - Handles & Cartridges | D-25 |
| Cartridges - WALTEC | D-38 | O - Ring Kits | D-41 |
| CHICAGO - Handles & Cartridges | D-2 | O - Ring | D-42 |
| Coloured Faucet Washers | D-46 | Pick - O - Ring | D-46 |
| CRANE - Handles & Cartridges | D-3 | POWERS CRANE Stem Kit | D-26 |
| CUTHBERT- Handles & Cartridges | D-6 | POWERS CRANE - Handles | D-26 |
| DANFOSS - Handles & Cartridges | D-8 | POWERS CRANE Rebuild Kits | D-26 |
| Deck Spouts | D-40 | PRICE PFISTER - Handles & Cartridges | D-27 |
| DELTA - Handles & Cartridges | D-9 | Screw Kits, Handle & Bibb | D-50 |
| DELTA - Spouts | D-40 | Screws - Bulk Bibb & Handle Screws Seat Gauge | D-48 |
| Diverter - CUTHBERT | D-7 | Seat Gauge | D-49 |
| Diverter - EMCO | D-15 | Seats - CRANE | D-4 |
| Diverter - GALMASTER | D-18 | Seats - EMCO | D-15 |
| Diverter - MOEN | D-23 | Seats - MUELLER | D-25 |
| Diverter - PRICE PFISTER | D-29 | Seats - WALTEC | D-38 |
| Diverter - STERLING | D-31 | Spouts - Deck | D-40 |
| Diverter - WALLACEBURG | D-36 | Stem Gauge | D-49 |
| Diverter - WALTEC | D-39 | STERLING - Handles & Cartridges | D-30 |
| EMCO - Handles & Cartridges | D-15 | SYMMONS - Handles & Cartridges | D-32 |
| EMCO - Spouts | D-40 | T&S BRASS - Handles & Cartridges | D-34 |
| Fit All Handles | D-17 | VALLEY - Handles & Cartridges | D-35 |
| Flat Washer Kits | D-47 | WALLACEBURG Cartridges & Diverter | D-36 |
| GALMASTER Cartridges | D-18 | WALTEC - Handles & Cartridges | D-37 |
| Gauges - Seat, Handle, Stem | D-49 | WALTEC - Spouts | D-40 |
| GERBER - Handles & Cartridges | D-19 | Washer - Beveled | D-48 |
| Grease - Stem | D-46 | Washers - Bibb | D-48 |
| Handle Screws | D-48 | Washers - Kits | D-48 |
| Handles - Am/Std. | D-1 | | |

AMERICAN STANDARD

| | | | | | |
|---|-------------------|----------------------------------|--|-------------------|------------------------------|
| <p>SINGLE LEVER HANDLE 3-1/4" FOR KITCHEN</p>  <ul style="list-style-type: none"> - AQUARIAN ONE small - 3-1/4" for kitchen - OEM ref#77033-02 | | | <p>SINGLE LEVER HANDLE FOR LAVATORY</p>  <ul style="list-style-type: none"> - AQUARIAN ONE large - 4-7/8" for lavatory - OEM ref#77031-02 | | |
| PART# | BULK PART# | DESCRIPTION | PART# | BULK PART# | DESCRIPTION |
| 7070 | 7070Q | AQUARIAN ONE small - for kitchen | 7071 | 7071Q | AQUARIAN ONE large - for lav |
| <p>SINGLE LEVER HANDLE</p>  <ul style="list-style-type: none"> - AQUARIAN TWO small - 3-1/4" for small - OEM ref#70545-02 | | | <p>SINGLE LEVER HANDLE</p>  <ul style="list-style-type: none"> - AQUARIAN TWO large - 5-1/2" large - OEM ref#37982-02 | | |
| PART# | BULK PART# | DESCRIPTION | PART# | BULK PART# | DESCRIPTION |
| 7072 | 7072Q | AQUARIAN TWO small | 7073 | 7073Q | AQUARIAN TWO large |
| <p>HERITAGE LEVER DOME HANDLE</p>  <ul style="list-style-type: none"> - Hot / cold pair - For kitchen & lavatory - 1-5/16" height | | | <p>WRIST BLADE HANDLE</p>  <ul style="list-style-type: none"> - Hot / cold pair - For service sink - 4-1/2" long | | |
| PART# | BULK PART# | DESCRIPTION | PART# | BULK PART# | DESCRIPTION |
| 7081 | 7081Q | For kitchen & lavatory | 7082 | 7082Q | For service sink |
| <p>AQUASEAL CARTRIDGES</p>  <ul style="list-style-type: none"> - Hot OEM ref#G72950-17 - Cold OEM ref#G72951-17 - Diaphragm OEM ref#G72940-07 - Seat OEM ref#861-14 | | | <p>HERITAGE HANDLES DIE CAST METAL</p>  <ul style="list-style-type: none"> - Hot / cold pair - Small OEM ref#6458-021 - Large OEM ref#6459-0221 - Widespread OEM ref#6459-021 | | |
| PART# | BULK PART# | DESCRIPTION | PART# | BULK PART# | DESCRIPTION |
| 2031 | 2031Q | AQUASEAL hot | 7076 | 7076Q | Small 1-9/16" short broach |
| 2032 | 2032Q | AQUASEAL cold | 7077 | 7077Q | Large 1-5/8 long broach T&S |
| 2033 | 2033Q | Diaphragm washer | 7078 | 7078Q | Diverter 1-5/8 long broach |
| 2034 | 2034Q | Seat 7/16" x 24TPI | 7079 | 7079Q | Widespread 1-5/8" |
| <p>OEM (Original Equipment Manufacturer) numbers, registered / non registered trademarks, faucet name, and manufacturer listed above are supplied and listed for your reference only. All LynCar items are precision made and tested to the highest standards, by qualified factories inspected and approved by LynCar.</p> | | | | | |

FAUCET REPAIR

BRADLEY / CHICAGO

BRADLEY BRAD-TROL CARTRIDGE DIVERTER



- OEM ref#300-0050

| PART# | BULK PART# | DESCRIPTION |
|-------|------------|--------------------|
| 9009 | 9009Q | Cartridge diverter |

BRADLEY BRAD-TROL CARTRIDGE



- Supplied with seat
- Hot OEM ref#400-08190
- Cold OEM ref#400-08290

| PART# | BULK PART# | DESCRIPTION |
|-------|------------|-------------|
| 9012 | 9012Q | Hot |
| 9013 | 9013Q | Cold |

CHICAGO - QUATURN CARTRIDGES NEW STYLE



- Exposed cap
- Hot OEM ref#1-100XK
- Cold OEM ref#1-99-XK

| PART# | BULK PART# | DESCRIPTION |
|-------|------------|-------------|
| 9016 | 9016Q | Hot |
| 9017 | 9017Q | Cold |

CHICAGO - QUATURN LEVER HANDLES



- Hot / cold pair
- For faucet sink

| PART# | BULK PART# | DESCRIPTION |
|-------|------------|-------------|
| 9018 | 9018Q | Pair lever |

OEM (Original Equipment Manufacturer) numbers, registered / non registered trademarks, faucet name, and manufacturer listed above are supplied and listed for your reference only. All LynCar items are precision made and tested to the highest standards, by qualified factories inspected and approved by LynCar.

CRANE

CRANE 5 RIB HANDLES



- Hot / cold pair
- Metal handle
- Small OEM ref#355151
- Medium OEM ref#355154
- Large OEM ref#355157

| PART# | BULK PART# | DESCRIPTION |
|-------|------------|----------------------|
| 931 | 931Q | Small 1-1/4" height |
| 932 | 932Q | Medium 1-1/2" height |
| 933 | 933Q | Large 1-3/4" height |

CRANE ACRYLIC HANDLES



- Hot / cold pair
- Small OEM ref#355374
- Medium OEM ref#355384
- Large OEM ref#355371

| PART# | BULK PART# | DESCRIPTION |
|-------|------------|----------------------|
| 934 | 934Q | Small 1-1/2" height |
| 935 | 935Q | Medium 1-5/8" height |
| 936 | 936Q | Large 1-3/4" height |

CRANE CAMEO HANDLES



- Hot / cold pair
- 3 rib style
- Small OEM ref#355556
- Large OEM ref#355558

| PART# | BULK PART# | DESCRIPTION |
|-------|------------|---------------------|
| 2020 | 2020Q | Small 1-5/16 height |
| 2021 | 2021Q | Large 1-3/4 height |

CRANE INDEX BUTTONS



- For 5 rib style handles
- Small hot / cold pair OEM ref#3300877 / 78
- Medium hot / cold pair OEM ref#300880 / 81
- Large hot / cold pair OEM ref#301918 / 19

| PART# | BULK PART# | DESCRIPTION |
|-------|------------|-------------------------------|
| 12626 | 12626Q | Small hot / cold pair 13/16" |
| 12627 | 12627Q | Medium hot / cold pair 15/16" |
| 12628 | 12628Q | Large hot / cold pair 13/16" |

OEM (Original Equipment Manufacturer) numbers, registered / non registered trademarks, faucet name, and manufacturer listed above are supplied and listed for your reference only. All LynCar items are precision made and tested to the highest standards, by qualified factories inspected and approved by LynCar.

CRANE

CRANE DIALESE CARTRIDGE



- Hot or cold cartridge
- OEM ref#354001, 354002

| PART# | BULK PART# | DESCRIPTION |
|-------|------------|----------------|
| 907 | 907Q | Hot cartridge |
| 908 | 908Q | Cold cartridge |

CRANE DIALESE STEM REPLACEMENT



- Replacement stem only
- OEM ref#300107, 300108

| PART# | BULK PART# | DESCRIPTION |
|-------|------------|----------------|
| 916 | 916Q | Hot stem only |
| 917 | 917Q | Cold stem only |

CRANE CAMEO CARTRIDGE



- Hot or cold cartridge
- For CAMEO
- OEM ref#355160

| PART# | BULK PART# | DESCRIPTION |
|-------|------------|-------------------|
| 918 | 918Q | Fits hot and cold |

CRANE SEATS



- CRANE CAMEO seat OEM ref#301705
- CRANE CAMEO T/S seat

| PART# | BULK PART# | DESCRIPTION |
|-------|------------|--|
| 11197 | 11197Q | CAMEO Seat 9/16 x 18 TPI |
| 11196 | 11196Q | CRANE T/S extended seat 1/2 x 18 TPI x 2 3/4" long |

OEM (Original Equipment Manufacturer) numbers, registered / non registered trademarks, faucet name, and manufacturer listed above are supplied and listed for your reference only. All LynCar items are precision made and tested to the highest standards, by qualified factories inspected and approved by LynCar.

CRANE

CRANE WASHER



- Bottom Washer for DIALESE
- 1 pair of washers or bulk pack of 25 pieces

| PART# | BULK PART# | DESCRIPTION |
|-------|------------|--------------|
| 12623 | 12623Q | CRANE washer |

CRANE CORK WASHER



- Washer for DIALESE
- Bulk pack 25 pieces

| PART# | DESCRIPTION |
|-------|---------------------|
| 12622 | Bulk pack 25 pieces |

CRANE DIALESE REPAIR KITS



- 1 kit or bulk pack 25 kits

| PART# | BULK PART# | DESCRIPTION |
|-------|------------|-------------|
| 908R | 908RQ | Repair kit |

OEM (Original Equipment Manufacturer) numbers, registered / non registered trademarks, faucet name, and manufacturer listed above are supplied and listed for your reference only. All LynCar items are precision made and tested to the highest standards, by qualified factories inspected and approved by LynCar.

CUTHBERT & BELANGER

CUTHBERT NOVA HANDLE



- Hot / cold pair
- Also fits BELANGER
- 1-1/2" height

BELANGER CHROME PLATED DIE CAST HANDLE



- Hot / cold pair
- 1-1/2" height

| PART# | BULK PART# | DESCRIPTION |
|-------|------------|-----------------|
| 937 | 937Q | Hot / cold pair |

| PART# | BULK PART# | DESCRIPTION |
|-------|------------|-----------------|
| 881 | 881Q | Hot / cold pair |

CUTHBERT C2 CARTRIDGE



- Lavatory & kitchen
- Fits hot & cold

CUTHBERT M2 CARTRIDGE



- Lavatory & kitchen

| PART# | BULK PART# | DESCRIPTION |
|-------|------------|----------------------|
| 904 | 904Q | Hot / cold cartridge |

| PART# | BULK PART# | DESCRIPTION |
|-------|------------|--------------|
| 909 | 909Q | M2 cartridge |

CUTHBERT M3 CARTRIDGE



- Tub & shower

CUTHBERT / BELANGER SEATS



- 1/2 x 20 tpi seat CUTHBERT
- OEM ref#0054
- 9/16 x 24 tpi seat CUTHBERT BELANGER
- OEM ref#0057A

| PART# | BULK PART# | DESCRIPTION |
|-------|------------|--------------|
| 897 | 897Q | M3 cartridge |

| PART# | BULK PART# | DESCRIPTION |
|-------|------------|---------------|
| 12824 | 12824Q | 1/2 x 20 tpi |
| 12825 | 12825Q | 9/16 x 24 tpi |

OEM (Original Equipment Manufacturer) numbers, registered / non registered trademarks, faucet name, and manufacturer listed above are supplied and listed for your reference only. All LynCar items are precision made and tested to the highest standards, by qualified factories inspected and approved by LynCar.

CUTHBERT

CUTHBERT DIVERTER



- Tub and shower diverter
- OEM ref#1268-41

| PART# | BULK PART# | DESCRIPTION |
|-------|------------|-------------|
| 898 | 898Q | Diverter |

CUTHBERT DIVERTER



- Tub and shower diverter
- OEM ref#FC91268-41

| PART# | BULK PART# | DESCRIPTION |
|-------|------------|-------------|
| 888 | 888Q | Diverter |

CUTHBERT / BELANGER



- Tub and shower diverter
- Assembly for built in models
- OEM ref#1960-5A

| PART# | BULK PART# | DESCRIPTION |
|-------|------------|-------------|
| 887 | 887Q | Diverter |

OEM (Original Equipment Manufacturer) numbers, registered / non registered trademarks, faucet name, and manufacturer listed above are supplied and listed for your reference only. All LynCar items are precision made and tested to the highest standards, by qualified factories inspected and approved by LynCar.

DANFOSS TEMPRESS

DANFOSS TEMPRESS II SHOWER ESCUTCHEON



- Replacement shower escutcheon for DANFOSS TEMPRESS II
- Chrome plated
- 7-1/8" diameter

| PART# | DESCRIPTION |
|-------|------------------|
| 9120 | Escutcheon plate |

PRESSURE BALANCE CARTRIDGE WITH O RING



- Fits DANFOSS TEMPRESS II (OEM ref#062N1285) GROHE (OEM ref#6-3301-5-4), VALLEY, EMCO and POWERS
- Pressure balance cartridge

| PART# | BULK PART# | DESCRIPTION |
|-------|------------|-------------|
| 922 | 922Q | Cartridge |

DANFOSS TEMPRESS II CHROME HANDLE & CAP



- Handle and cap for DANFOSS TEMPRESS II chrome plated handle and snap in black cap
- Cap OEM ref# 062N0375
- Handle OEM ref# 062N0250
- Chrome plastic
- Extender included (LynCar part#922E)

| PART# | BULK PART# | DESCRIPTION |
|-------|------------|------------------------------|
| 9119 | 9119Q | Chrome plated plastic handle |

DANFOSS / EMCO TEMPRESS STEM EXTENDER



- DANFOSS pressure balance faucet handle stem adapter

| PART# | BULK PART# | DESCRIPTION |
|-------|------------|---------------|
| 922E | 922EQ | Stem extender |

OEM (Original Equipment Manufacturer) numbers, registered / non registered trademarks, faucet name, and manufacturer listed above are supplied and listed for your reference only. All LynCar items are precision made and tested to the highest standards, by qualified factories inspected and approved by LynCar.

DELTA

DELTA CANOPY HANDLES



- Hot / cold pair
- Fits DELTA & PEERLESS
- OEM ref#RP6062
- 1-3/4" height

| PART# | BULK PART# | DESCRIPTION |
|-------|------------|-----------------|
| 2022 | 2022Q | Hot / cold pair |

DELTA CRYSTAL HANDLES OLD STYLE



- Hot / cold pair
- Tub & shower height 2-5/16"
- Lavatory & kitchen height 1-7/8"
- OEM ref#RP5693

| PART# | BULK PART# | DESCRIPTION |
|-------|------------|---------------|
| 2023 | 2023Q | Tub & shower |
| 2030 | 2030Q | Lav & kitchen |

DELTA / DELEX WIDESPREAD HANDLE



- Hot / cold pair
- For lavatory, kitchen, tub and shower
- Lavatory height 2"
- OEM ref#RP17449

| PART# | BULK PART# | DESCRIPTION |
|-------|------------|-------------|
| 13005 | 13005Q | Widespread |

FAUCET REPAIR

OEM (Original Equipment Manufacturer) numbers, registered / non registered trademarks, faucet name, and manufacturer listed above are supplied and listed for your reference only. All LynCar items are precision made and tested to the highest standards, by qualified factories inspected and approved by LynCar.

DELTA

DELTA TUB AND SHOWER HANDLE



- Single acrylic handle
- Fits #70 ball faucets
- Metal adapter insert
- 1-3/4" diameter x 2-1/4" tall

| PART# | BULK PART# | DESCRIPTION |
|-------|------------|-------------|
| 13002 | 13002Q | Handle |

DELTA ACRYLIC HANDLES



- Single acrylic handle
- Lavatory height 2" OEM ref#RP2389
- Tub & shower height 2-1/8" OEM ref#RP2391
- Scaldguard height 2-1/4" OEM ref#RP2392

| PART# | BULK PART# | DESCRIPTION |
|-------|------------|--------------|
| 13011 | 13011Q | Lavatory |
| 13009 | 13009Q | Tub & shower |
| 13007 | 13007Q | Scaldguard |

DELTA LEVER FAUCET HANDLE



- Single die cast metal handle, chrome
- Fits DELTA, PRICE PFISTER, AMERICAN STANDARD bath and tub and shower faucets
- 4" long x 2" tall

| PART# | DESCRIPTION |
|-------|--------------|
| 1304 | Lever handle |

DELTA

DELTA LEVER FAUCET LONG KITCHEN LEVER

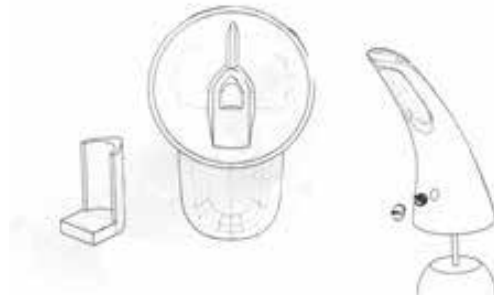

- Single die cast chrome metal handle
- Fits DELTA kitchen faucets
- Fits #70 and #212 ball faucets

| PART# | BULK PART# | DESCRIPTION |
|-------|------------|--------------------|
| 1305 | 1305Q | Long kitchen lever |

DELTA SHOWER HANDLE, LEVER



- Single die cast chrome metal handle
- Complete with three cartridge adaptors, for 70 ball, 212 ball, & pressure balance cartridge rp19804
- For Series 600 valves and Monitor 14 series

| PART# | BULK PART# | DESCRIPTION |
|-------|------------|---------------------|
| 1318 | 1318Q | Shower handle lever |

DELTA SHOWER HANDLE, ACRYLIC



- Acrylic handle for DELTA shower valve
- Complete with three cartridge adaptors, for 70 ball, 212 ball, & pressure balance cartridge rp19804
- For Series 600 valves and Monitor 14 series

| PART# | BULK PART# | DESCRIPTION |
|-------|------------|-----------------------|
| 1319 | 1319Q | Acrylic shower handle |

DELTA

DELTA BLADE HANDLES



- Hot / cold pair
- 4" blade handle
- OEM ref#RP12941
- Chrome plated

DELTA SINGLE LEVER HANDLE



- Small for Lavatory 3-1/4" handle OEM ref#RP90
- Large for Kitchen 5-1/4" handle OEM ref#RP2393
- Chrome plated

| PART# | BULK PART# | DESCRIPTION |
|-------|------------|--------------|
| 13022 | 13022Q | Blade handle |

| PART# | BULK PART# | DESCRIPTION |
|-------|------------|-------------|
| 13023 | 13023Q | Small |
| 13024 | 13024Q | Large |

DELTA REPAIR KITS



- Repair kit for single lever faucet
- DELTA & PEERLESS OEM ref#RP3614
- Replacement wrench OEM ref#RP1974

DELTA H79 MONITOR LEVER HANDLE

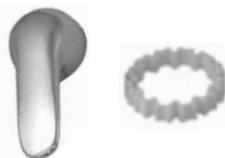

- For 1400 Series, single
- Chrome Plate Brass
- 4-1/4" overall

| PART# | BULK PART# | DESCRIPTION |
|-------|------------|-------------|
| 12829 | 12829Q | Kit |
| 12830 | 12830Q | Wrench only |

| PART# | DESCRIPTION |
|-------|-------------|
| 13010 | H79 handle |

DELTA SPRING AND SEATS



- Sold separately, or as a kit of both
- Part#13012 OEM ref#RP1806
- Part#13013 OEM ref#RP1505
- Part#13014 OEM ref#RP3427
- Part#13015 OEM ref# RP1181

DELTA INDEX BUTTONS



- DELTA index buttons
- Part#13017 OEM ref#RP2412
- Part#13019 OEM ref#RP1711C

| PART# | BULK PART# | DESCRIPTION |
|-------|------------|----------------------|
| 13012 | 13012Q | Seat new style |
| 13013 | 13013Q | Seat old style |
| 13014 | 13014Q | Spring new conical |
| 13015 | 13015Q | Spring old straight |
| 13016 | | Repair kit old style |
| 13018 | | Repair kit new style |

| PART# | BULK PART# | DESCRIPTION |
|-------|------------|-------------------------------|
| 13017 | 13017Q | For DELTA / PEERLESS H/C |
| 13019 | 13019Q | For CRYSTAL handle prior 1991 |
| 2019 | 2019Q | For DELTA acrylic handles |

OEM (Original Equipment Manufacturer) numbers, registered / non registered trademarks, faucet name, and manufacturer listed above are supplied and listed for your reference only. All LynCar items are precision made and tested to the highest standards, by qualified factories inspected and approved by LynCar.

DELTA

DELTA / DELEX CARTRIDGE



- For two handle faucets
- Stainless steel bottom
- Plastic body
- OEM ref#RP1740

| PART# | BULK PART# | DESCRIPTION |
|-------|------------|-------------------------|
| 11210 | 11210Q | DELTA / DELEX cartridge |

DELTA BALLS



- Available in plastic or stainless steel
- Part#927 & part#927Q OEM ref#RP70
- Part#927A & part#927AQ OEM ref#RP212

| PART# | BULK PART# | DESCRIPTION |
|-------|------------|------------------|
| 926 | 926Q | Plastic |
| 927 | 927Q | S/S for DELTA |
| 927A | 927AQ | S/S for PEERLESS |

DELTA SCALDGUARD CARTRIDGE



- For kitchen lavatory and tub & shower
- OEM ref#RP1991

| PART# | BULK PART# | DESCRIPTION |
|-------|------------|----------------------------|
| 11212 | 11212Q | DELTA scaldguard cartridge |

PLASTIC REPLACEMENT CARTRIDGE



- For PEERLESS Plastic Body

| PART# | BULK PART# | DESCRIPTION |
|-------|------------|-----------------------|
| 11215 | 11215Q | Replacement cartridge |

DELTA PRESSURE BALANCE CARTRIDGE



- For 1300 /1400 Series
- OEM ref#RP19804

| PART# | BULK PART# | DESCRIPTION |
|-------|------------|----------------------------|
| 11222 | 11222Q | Pressure balance cartridge |

DELTA PUSH BUTTON DIVERTER



- For lavatory kitchen tub and shower
- 3-3/4" long
- OEM ref#RP5649

| PART# | BULK PART# | DESCRIPTION |
|-------|------------|----------------------|
| 11220 | 11220Q | Push button diverter |

OEM (Original Equipment Manufacturer) numbers, registered / non registered trademarks, faucet name, and manufacturer listed above are supplied and listed for your reference only. All LynCar items are precision made and tested to the highest standards, by qualified factories inspected and approved by LynCar.

DELTA

**DELTA / CAMBRIDGE BRASS
TEMPUS METERING REPLACEMENT**



- DELTA / CAMBRIDGE brass tempus metering
- Replacement cartridge
- For single and 4" centreset faucets
- OEM ref#060160A

DELTA SLOW CLOSE CARTRIDGE



- For lavatory, kitchen and tub / shower
- Commercial cartridge valve stem

| PART# | BULK PART# | DESCRIPTION |
|-------|------------|--------------------------------|
| 11350 | 11350Q | DELTA / CAMBRIDGE brass tempus |

| PART# | BULK PART# | DESCRIPTION |
|-------|------------|----------------------|
| 11225 | 11225Q | Slow close cartridge |

DELTA TUB SHOWER CARTRIDGE



- For DELEX three handle
- OEM ref#RP17730

| PART# | BULK PART# | DESCRIPTION |
|-------|------------|----------------------|
| 11223 | 11223Q | Tub shower cartridge |

DELTA BRASS DIVERTER



- DELTA diverter for single handle kitchen faucet with diverter
- OEM ref#RP230

| PART# | BULK PART# | DESCRIPTION |
|-------|------------|----------------|
| 13021 | 13021Q | Brass diverter |

OEM (Original Equipment Manufacturer) numbers, registered / non registered trademarks, faucet name, and manufacturer listed above are supplied and listed for your reference only. All LynCar items are precision made and tested to the highest standards, by qualified factories inspected and approved by LynCar.

EMCO

EMCO ELAN CARTRIDGE HOT / COLD



- OEM ref#1157

| PART# | BULK PART# | DESCRIPTION |
|-------|------------|-------------|
| 919 | 919Q | Cartridge |

EMCO SEATS



- Standard OEM ref#51-137169
- Extended OEM ref#51-137719

| PART# | BULK PART# | DESCRIPTION |
|-------|------------|----------------------------|
| 12820 | 12820Q | 9/16 x 27 TPI |
| 923 | 923Q | 9/16 x 27 TPI x 1-1/8" T/S |

EMCO DIVERTER CARTRIDGE NEW STYLE FACEMOUNT



- Chrome plated brass knob
- Height 3-3/4"
- OEM ref#51-193782

| PART# | BULK PART# | DESCRIPTION |
|-------|------------|--------------------|
| 920 | 920Q | Diverter cartridge |

EMCO DIVERTER FOR CONCEALED TUB & SHOWER



- Chrome brass knob
- Height 6-1/2"
- OEM ref#51-193209

| PART# | BULK PART# | DESCRIPTION |
|-------|------------|-------------|
| 9231 | 9231Q | Diverter |
| 9231H | 9231HQ | Knob only |

EMCO DIVERTER DORIC STYLE FOR 3 VALVE TUB & SHOWER



- Height 4"
- OEM ref#51-138966

| PART# | BULK PART# | DESCRIPTION |
|-------|------------|-------------|
| 921 | 921Q | Diverter |

EMCO DIVERTER FACEMOUNT TUB AND SHOWER



- Height 2-1/2" (3-1/4" with Handle)
- OEM ref#51-193210

| PART# | BULK PART# | DESCRIPTION |
|-------|------------|-------------|
| 12821 | 12821Q | Diverter |

OEM (Original Equipment Manufacturer) numbers, registered / non registered trademarks, faucet name, and manufacturer listed above are supplied and listed for your reference only. All LynCar items are precision made and tested to the highest standards, by qualified factories inspected and approved by LynCar.

EMCO

EMCO CORONA HANDLES CHROME PLATED PLASTIC



- Hot / cold pair
- Chrome plated plastic
- Large height 1-3/4" OEM ref#1299, Small height 1-1/2" OEM ref#2198

| PART# | BULK PART# | DESCRIPTION |
|-------|------------|-------------|
| 2003 | 2003Q | Large |
| 2004 | 2004Q | Small |

EMCO CORONA HANDLES CHROME PLATED METAL



- Hot / cold pair
- Large height 1-3/4" OEM ref#2199, Small height 1-3/2" OEM ref#2198M

| PART# | BULK PART# | DESCRIPTION |
|-------|------------|-------------|
| 2006 | 2006Q | Large |
| 2005 | 2005Q | Small |

EMCO SAPPHIRE CHROME PLATED ACRYLIC HANDLES



- Hot / cold pair
- Chrome plated acrylic handles
- Large OEM ref#2399, Small OEM ref#2398

| PART# | BULK PART# | DESCRIPTION |
|-------|------------|-------------|
| 2024 | 2024Q | Small |
| 2025 | 2025Q | Large |

EMCO LAUNDRY HANDLES PLASTIC HANDLE WITH SCREW



- Red (hot) OEM ref#51-195641
- Blue (cold) OEM ref#51-195640

| PART# | BULK PART# | DESCRIPTION |
|-------|------------|-------------|
| 2013 | 2013Q | Red |
| 2014 | 2014Q | Blue |

EMCO 1057 CARTRIDGE HOT / COLD



- OEM ref#1057

| PART# | BULK PART# | DESCRIPTION |
|-------|------------|-------------|
| 900 | 900Q | Cartridge |

EMCO LAUNDRY CARTRIDGE HOT / COLD



- Hot / cold
- OEM ref#51-195223

| PART# | BULK PART# | DESCRIPTION |
|-------|------------|-------------|
| 899 | 899Q | Cartridge |

EMCO REPLACEMENT HANDLE INSERTS



- Sold in pairs
- EMCO replacement handle inserts
- For EMCO CORONA handles
- Metal and plastic handles
- New style OEM ref#51-194943
- Old style OEM ref#51-191032

| PART# | BULK PART# | DESCRIPTION |
|-------|------------|-------------|
| 891 | 891Q | New style |
| 892 | 892Q | Old style |

EMCO REPLACEMENT INDEX BUTTONS



- EMCO replacement index buttons
- For EMCO CORONA handles
- Metal and plastic handles
- OEM ref#51-197775/6

| SMALL PART# | LARGE PART# | DESCRIPTION |
|-------------|-------------|-------------|
| 2026 | 2027 | H/C plastic |
| 2028 | 2029 | H/C metal |

OEM (Original Equipment Manufacturer) numbers, registered / non registered trademarks, faucet name, and manufacturer listed above are supplied and listed for your reference only. All LynCar items are precision made and tested to the highest standards, by qualified factories inspected and approved by LynCar.

FIT ALL

FIT ALL HANDLE ACRYLIC STYLE



- Hot / cold pair
- Small, large, diverter
- Supplied with adaptor and Allen Key

| PART# | BULK PART# | DESCRIPTION |
|-------|------------|-------------------------------|
| 12931 | 12931Q | Tub & shower - large |
| 12932 | 12932Q | Diverter tub & shower - large |
| 12933 | 12933Q | Lav & kitchen - small |

FIT ALL HANDLE METAL DOME CANOPY STYLE



- Hot / cold pair
- Small, medium and large
- Supplied with adaptor and Allen Key

| PART# | BULK PART# | DESCRIPTION |
|-------|------------|--------------------------------|
| 12945 | 12945Q | Lavatory small - height 1-1/4" |
| 12950 | 12950Q | Kitchen - height 1-1/2" |
| 12955 | 12955Q | Tub & shower - height 1-3/4" |

FIT ALL HANDLE LEVER METAL STYLE



- Hot / cold pair
- Small and large
- Supplied with adaptor and Allen Key

| PART# | BULK PART# | DESCRIPTION |
|-------|------------|--------------------------------|
| 12915 | 12915Q | Lavatory small - height 1-3/8" |
| 12920 | 12920Q | Kitchen - height 1-1/2" |

FIT ALL HANDLE METAL CROSS HANDLE STYLE



- Hot / cold pair
- Supplied with adaptor and Allen Key

| PART# | BULK PART# | DESCRIPTION |
|-------|------------|---------------|
| 12940 | 12940Q | Cross handles |

FIT ALL DECORATIVE CHROME HANDLE



- Decorative handle assembly, fits most faucets
- Adaptors, screws, included
- Chrome plated brass handle, die cast housing
- Sold per pair

| PART# | DESCRIPTION |
|-------|-------------|
| 12960 | Chrome |

FIT ALL DECORATIVE PORCELAIN HANDLE



- Decorative handle assembly, fits most faucets
- Adaptors, screws, included
- Chrome plated brass and porcelain handle, die cast housing
- Sold per pair

| PART# | DESCRIPTION |
|-------|-------------|
| 12962 | Porcelain |

OEM (Original Equipment Manufacturer) numbers, registered / non registered trademarks, faucet name, and manufacturer listed above are supplied and listed for your reference only. All LynCar items are precision made and tested to the highest standards, by qualified factories inspected and approved by LynCar.

GALTMASTER

GALTMASTER DIVERTER CARTRIDGE



- For shower valves 1953 to 1963
- 4-3/4" overall Length
- OEM ref#70281

GALTMASTER STEM REPLACEMENT



- For shower valves 1933 to 1969
- 4" overall length
- OEM ref#70283

| PART# | BULK PART# | DESCRIPTION | PART# | BULK PART# | DESCRIPTION |
|-------|------------|--------------------|-------|------------|------------------|
| 890 | 890Q | Diverter cartridge | 895 | 895Q | Stem replacement |

GALTMASTER DIVERTER STEM T/S



- For shower valves 1954/63
- 5-3/8" overall length
- OEM ref#70282

GALTMASTER STEM REPLACEMENT T/S



- For shower valves 1963 to 1965
- 5-1/4" overall length
- OEM ref#70284

| PART# | BULK PART# | DESCRIPTION | PART# | BULK PART# | DESCRIPTION |
|-------|------------|--------------------------|-------|------------|------------------|
| 879 | 879Q | GALTMASTER diverter stem | 878 | 878Q | Stem replacement |

GALT L.H COLD CARTRIDGE (1963—1970)



- 1-3/4" length
- OEM ref#70012

GALT R.H HOT CARTRIDGE (1963—1970)



- 1-3/4" length
- OEM ref#70080

| PART# | BULK PART# | DESCRIPTION | PART# | BULK PART# | DESCRIPTION |
|-------|------------|--------------------|-------|------------|-------------------|
| 894 | 894Q | L.H cold cartridge | 893 | 893Q | R.H hot cartridge |

OEM (Original Equipment Manufacturer) numbers, registered / non registered trademarks, faucet name, and manufacturer listed above are supplied and listed for your reference only. All LynCar items are precision made and tested to the highest standards, by qualified factories inspected and approved by LynCar.

GERBER

GERBER WATERLESS CARTRIDGE HOT



- 1-3/4" overall length
- OEM ref#98-710

GERBER WATERLESS CARTRIDGE COLD



- 1-3/4" overall length
- OEM ref#98-711

| PART# | BULK PART# | DESCRIPTION | PART# | BULK PART# | DESCRIPTION |
|-------|------------|-------------------------|-------|------------|--------------------------|
| 954 | 954Q | Waterless cartridge hot | 955 | 955Q | Waterless cartridge cold |

GERBER HANDLE DIE CAST METAL, CHROME



- Hot / cold pair
- Short broach
- 2-1/2" overall length
- OEM ref#98-443H/C

GERBER HANDLE DIE CAST METAL, CHROME



- Hot / cold pair
- Long broach
- 2-1/2" overall length
- OEM ref#98-427/28

| PART# | BULK PART# | DESCRIPTION | PART# | BULK PART# | DESCRIPTION |
|-------|------------|--------------|-------|------------|-------------|
| 9540 | 9540Q | Short broach | 9541 | 9541Q | Long broach |

FAUCET REPAIR

OEM (Original Equipment Manufacturer) numbers, registered / non registered trademarks, faucet name, and manufacturer listed above are supplied and listed for your reference only. All LynCar items are precision made and tested to the highest standards, by qualified factories inspected and approved by LynCar.

JAMECO

JAMECO LEVER HANDLES



- Hot / cold pair
- Chrome metal
- OEM ref#1010

JAMECO CROWN HANDLES



- Hot / cold pair
- Chrome metal
- OEM ref#1092

| PART# | BULK PART# | DESCRIPTION |
|-------|------------|--------------|
| 12827 | 12827Q | Chrome metal |

| PART# | BULK PART# | DESCRIPTION |
|-------|------------|--------------|
| 12826 | 12826Q | Chrome metal |

JAMECO FAUCET CARTRIDGE FOR WASHER TYPE FAUCETS



- 1-3/4" overall length
- OEM ref#1100 Hot
- OEM ref#1101 Cold

| PART# | BULK PART# | DESCRIPTION |
|-------|------------|-------------|
| 905 | 905Q | Hot |
| 906 | 906Q | Cold |

JAMECO FAUCET SEAT



- 1/2" x 20 TPI
- OEM ref#1102
- Sold per pair

| PART# | BULK PART# | DESCRIPTION |
|-------|------------|--------------------|
| 12822 | 12822Q | JAMECO faucet seat |

OEM (Original Equipment Manufacturer) numbers, registered / non registered trademarks, faucet name, and manufacturer listed above are supplied and listed for your reference only. All LynCar items are precision made and tested to the highest standards, by qualified factories inspected and approved by LynCar.

MIXET

**MIXET ROUND HANDLE
CLEAR ACRYLIC T/S HANDLE**



- MIXET round handle
- Die cast metal, chrome
- T/S handle
- 2-1/4" diameter
- OEM ref#MRH MET

**MIXET LEVER HANDLE
CLEAR ACRYLIC T/S HANDLE**



- Clear acrylic T/S handle
- 2-3/8" diameter
- OEM ref#MLH CLR

| PART# | BULK PART# | DESCRIPTION | PART# | BULK PART# | DESCRIPTION |
|-------|------------|-------------|-------|------------|-------------|
| 13025 | 13025Q | Acrylic | 13026 | 13026Q | Acrylic |
| 13030 | 13030Q | Metal | | | |

**MIXET LEVER INNER HANDLE
VOLUME CONTROL LEVER**



- part#13029**
- Chrome plated die cast metal
 - 2-1/4" lever, 4-1/2" overall

- part# 13031**
- Volume control lever
 - Chrome plastic
 - 2-3/4" lever, 5" overall
 - OEM ref#MLH CP

MIXET LEVER METAL



- MIXET single lever
- Handicap volume control
- OEM ref# MLH-HH



| PART# | BULK PART# | DESCRIPTION | PART# | DESCRIPTION |
|-------|------------|------------------------------|-------|---------------------------|
| 13029 | 13029Q | 2-1/4" lever, 4-1/2" overall | 13032 | MIXET lever shower handle |
| 13031 | 13031Q | 2-3/4" lever, 5" overall | | |

**MIXET TUB & SHOWER CARTRIDGE
WITH CHROME RETAINER NUT**



- With chrome retainer nut
- Overall 4-3/8"
- OEM ref#MS5AT-C

MIXET REPLACEMENT SEAT



- Chrome brass
- 1/2" diameter 11/32 long
- Sold per pair

| PART# | BULK PART# | DESCRIPTION | PART# | BULK PART# | DESCRIPTION |
|-------|------------|------------------------|-------|------------|------------------------|
| 13027 | 13027Q | Tub & shower cartridge | 13028 | 13028Q | MIXET replacement seat |

OEM (Original Equipment Manufacturer) numbers, registered / non registered trademarks, faucet name, and manufacturer listed above are supplied and listed for your reference only. All LynCar items are precision made and tested to the highest standards, by qualified factories inspected and approved by LynCar.

MOEN

MOEN CHATEAU HANDLES SHORT BROACH, FOR FAUCET



- Short broach, for faucet OEM ref#94791
- Long broach for shower OEM ref#96797

| PART# | BULK PART# | DESCRIPTION |
|-------|------------|--------------|
| 2015 | 2015Q | Short broach |
| 2016 | 2016Q | Long broach |

MOEN LEGEND HANDLES SHORT BROACH, FOR FAUCET



- Short broach, for faucet OEM ref#13092
- Long broach for shower OEM ref#13094

| PART# | BULK PART# | DESCRIPTION |
|-------|------------|--------------|
| 2017 | 2017Q | Short broach |
| 2018 | 2018Q | Long broach |

MOEN CHATEAU SINGLE LEVER CAP AND HANDLE (SOLD SEPARATELY)



- Cap OEM ref#96790
- Handle OEM ref#10927

| PART# | BULK PART# | DESCRIPTION |
|--------|------------|-------------|
| 11275 | 11275Q | Cap only |
| 11275H | 11275HQ | Handle only |

MOEN POST TEMP HOT/COLD LEVER SHOWER HANDLE



- Chrome plated die cast
- 4-1/4" overall size
- OEM ref#14732

| PART# | BULK PART# | DESCRIPTION |
|-------|------------|------------------------|
| 11278 | 11278Q | Chrome plated die cast |

OEM (Original Equipment Manufacturer) numbers, registered / non registered trademarks, faucet name, and manufacturer listed above are supplied and listed for your reference only. All LynCar items are precision made and tested to the highest standards, by qualified factories inspected and approved by LynCar.

MOEN

MOEN TUB AND SHOWER LEVER FOR MOEN COMMERCIAL



- For MOEN COMMERCIAL
- 4" CP plastic handle
- OEM ref#13291

| PART# | BULK PART# | DESCRIPTION |
|--------------|---------------|----------------------|
| 11276 | 11276Q | 4" CP plastic handle |

MOEN ACRYLIC TUB AND SHOWER HANDLES



- Hot / cold pair
- Overall 2-1/2" height
- OEM ref#14359

| PART# | BULK PART# | DESCRIPTION |
|--------------|---------------|-----------------------|
| 11279 | 11279Q | Overall 2-1/2" height |

MOEN MAGNUM SHOWER CARTRIDGE



- 3-7/8" overall length
- OEM ref#1225B

| PART# | BULK PART# | DESCRIPTION |
|------------|-------------|----------------|
| 944 | 944Q | OEM ref# 1225B |

MOEN FAUCET CARTRIDGE



- Can be used on hot or cold
- For two handle faucets
- OEM ref#1224

| PART# | BULL PART# | DESCRIPTION |
|--------------|---------------|------------------|
| 11270 | 11270Q | Faucet cartridge |

OEM (Original Equipment Manufacturer) numbers, registered / non registered trademarks, faucet name, and manufacturer listed above are supplied and listed for your reference only. All LynCar items are precision made and tested to the highest standards, by qualified factories inspected and approved by LynCar.

MOEN

MOEN BRASS FAUCET SHOWER CARTRIDGE



- OEM ref#1200B
- 3-7/8" overall length

| PART# | BULK PART# | DESCRIPTION |
|-------|------------|------------------------------------|
| 11271 | 11271Q | MOEN brass faucet shower cartridge |

MOEN POSI-TEMP SHOWER CARTRIDGE



- Cycling valve
- OEM ref#1222B
- 4-1/8" overall length

| PART# | BULK PART# | DESCRIPTION |
|-------|------------|----------------------------|
| 11272 | 11272Q | Posi-temp shower cartridge |

MOEN HOT / COLD METERING CARTRIDGE



- Metering cartridge
- 3-3/8" overall length
- OEM ref#13652

| PART# | DESCRIPTION |
|-------|----------------|
| 11273 | 1/2" IPS shank |

MOEN CLIPS



- Retaining clips for single handle MOEN faucets
- 25 per bag
- 3 types available

| PART# | DESCRIPTION |
|-------|-------------|
| 11255 | Model# 883 |
| 11260 | Model# 1171 |
| 11265 | Model# 1883 |

OEM (Original Equipment Manufacturer) numbers, registered / non registered trademarks, faucet name, and manufacturer listed above are supplied and listed for your reference only. All LynCar items are precision made and tested to the highest standards, by qualified factories inspected and approved by LynCar.

MUELLER

D

MUELLER CARTRIDGE FOR CENTRESET



- Can be used on hot or cold
- For CENTRESET
- 2" overall length
- OEM ref#91470

MUELLER DIVERTER FOR BEAUTYCRAFT T/S



- For BEAUTYCRAFT T/S MARK III & MARK IV
- 4-1/4" overall length
- OEM ref#91286

| PART# | BULK PART# | DESCRIPTION | PART# | BULK PART# | DESCRIPTION |
|-------|------------|---------------|-------|------------|---------------------|
| 903 | 903Q | For CENTRESET | 943 | 943Q | For BEAUTYCRAFT T/S |

MUELLER DIVERTER FOR BEAUTYCRAFT T/S



- For BEAUTYCRAFT T/S, MARK III & MARK IV
- 5-1/4" overall length
- OEM ref#91406

MUELLER FAUCET SEAT



- 17/32 x 24 TPI

| PART# | BULK PART# | DESCRIPTION | PART# | BULK PART# | DESCRIPTION |
|-------|------------|---------------------|-------|------------|---------------------|
| 9030 | 9030Q | For BEAUTYCRAFT T/S | 9031 | 9031Q | MUELLER faucet seat |

OEM (Original Equipment Manufacturer) numbers, registered / non registered trademarks, faucet name, and manufacturer listed above are supplied and listed for your reference only. All LynCar items are precision made and tested to the highest standards, by qualified factories inspected and approved by LynCar.

FAUCET REPAIR

POWERS

POWERS CRANE REBUILD KITS



- For Shower Valves
- **Part#11410** is the picture shown
- **Part#11410** OEM ref#410-182
- **Part#11800** OEM ref#800-030
- **Part#11900** OEM ref#900-030

POWERS CRANE STEM KIT



- For 400 / 0410 models 1 to 3
- Stem, washers, O rings
- OEM ref#410-378

| PART# | DESCRIPTION |
|-------|--------------------|
| 11410 | For 400/410 series |
| 11800 | For 800 series |
| 11900 | For 900 series |

| PART# | DESCRIPTION |
|-------|-----------------------|
| 11414 | POWERS CRANE stem kit |

POWERS CRANE SHOWER VALVE HANDLE



- Smoked crystal, with handle cap included.
- OEM ref#401-090, 401086/80/90

POWERS CRANE SHOWER VALVE CARTRIDGE KITS



- Screw in cartridge spool
- Spring and washers
- For 800 and 900 series models
- OEM ref#800-163 , 900-232

| PART# | DESCRIPTION |
|-------|----------------------------------|
| 11412 | POWERS CRANE Shower Valve Handle |

| PART# | DESCRIPTION |
|-------|-------------|
| 11802 | For 800 |
| 11902 | For 900 |

POWERS CRANE SHOWER VALVE HANDLE



- Chrome die cast metal lever
- With two plastic inserts
- For 800 and 900 series valves
- OEM ref#800-036

POWERS CRANE SHOWER VALVE HANDLE



- Crystal round handle
- With cap, screw, and adaptors
- For 800 series valves
- OEM ref#800-200

| PART# | DESCRIPTION |
|-------|----------------------------------|
| 11198 | POWERS CRANE Shower Valve Handle |

| PART# | DESCRIPTION |
|-------|----------------------------------|
| 11804 | POWERS CRANE Shower Valve Handle |

OEM (Original Equipment Manufacturer) numbers, registered / non registered trademarks, faucet name, and manufacturer listed above are supplied and listed for your reference only. All LynCar items are precision made and tested to the highest standards, by qualified factories inspected and approved by LynCar.

PRICE PFISTER

PRICE PFISTER CANOPY HANDLES



- Hot / cold pair
- Chrome die cast handles
- Fits VERVE series
- Large 2-1/2" height
- Small 1-5/8" height
- OEM ref#940-320A , 941-321A

PRICE PFISTER ACRYLIC HANDLES



- Hot / cold pair
- Fits WINDSOR series
- Large 2-7/8" height
- Small 1-7/8" height
- OEM ref#940-740A , 940-730A

| PART# | SIZE | DESCRIPTION |
|---------------|-------|-----------------|
| 21510 | Large | Hot / cold pair |
| 21520 | Small | Hot / cold pair |
| 21510D | Large | Diverter |

| PART# | SIZE | DESCRIPTION |
|---------------|-------|-----------------|
| 21740 | Large | Hot / cold pair |
| 21730 | Small | Hot / cold pair |
| 21740D | Large | Diverter |

PRICE PFISTER METAL CHROME DIE CAST HANDLES



- Hot / cold pair
- Fits CONTEMPERA series
- Large 2-1/4" height
- Small 1-1/2" height
- OEM ref#940-050A , 940-060A

| PART# | SIZE | DESCRIPTION |
|---------------|-------|-----------------|
| 21020 | Large | Hot / cold pair |
| 21050 | Small | Hot / cold pair |
| 21020D | Large | Diverter |

PRICE PFISTER METAL CHROME DIE CAST HANDLES



- Hot / cold pair
- Chrome die cast handles
- Fits CROWN JEWEL series
- 1" height
- OEM ref#940-220 , 940-210

| PART# | DESCRIPTION |
|--------------|-----------------|
| 21210 | Hot / cold pair |

FAUCET REPAIR

OEM (Original Equipment Manufacturer) numbers, registered / non registered trademarks, faucet name, and manufacturer listed above are supplied and listed for your reference only. All LynCar items are precision made and tested to the highest standards, by qualified factories inspected and approved by LynCar.

PRICE PFISTER

PRICE PFISTER CARTRIDGE
COMPRESSION STEM



- For lav & kitchen
- Fits JEWEL, IMPERIAL and others
- Height 1-9/16
- OEM ref#910-072 (Hot) OEM ref#910 082 (Cold)

PRICE PFISTER CARTRIDGE
ALL BRASS STEM



- For lav & kitchen
- Fits COMTEMPRA, MARQUIS, VERVE
- Height 1-5/8
- OEM ref#910-392

PART# DESCRIPTION

| | |
|---------------|----------------|
| 21082H | Hot cartridge |
| 21082C | Cold cartridge |

PART# DESCRIPTION

| | |
|--------------|--------------------------------------|
| 21392 | Cartridge can be used on hot or cold |
|--------------|--------------------------------------|

PRICE PFISTER CARTRIDGE



- For lav & kitchen
- Fits CROWN JEWEL
- Height 1-7/8
- OEM ref#910-282 Hot 910 292 Cold

PART# DESCRIPTION

| | |
|---------------|----------------|
| 21282H | Hot cartridge |
| 21282C | Cold cartridge |

PRICE PFISTER CARTRIDGE



- For lav & kitchen
- Brass washerless cartridge
- Height 2"
- OEM ref#910-651

PART# DESCRIPTION

| | |
|--------------|--------------------------------------|
| 21681 | Cartridge can be used on hot or cold |
|--------------|--------------------------------------|

PRICE PFISTER SEATS



- Sold per pair
- For lav & kitchen
- 2 & 3 valves

PART# DESCRIPTION

| | |
|--------------|----------------------|
| 21500 | 21/32 x 18 TPI x 3/8 |
| 21502 | 1/2 x 20 TPI x 3/8 |

PRICE PFISTER SHOWER VALVE
FLANGES



- Tapered and hex style
- Chrome plated

PART# SIZE DESCRIPTION

| | | |
|--------------|---------|---------|
| 21110 | 2-3/16" | Tapered |
| 21280 | 1-3/4" | Hexagon |

OEM (Original Equipment Manufacturer) numbers, registered / non registered trademarks, faucet name, and manufacturer listed above are supplied and listed for your reference only. All LynCar items are precision made and tested to the highest standards, by qualified factories inspected and approved by LynCar.

PRICE PFISTER

PRICE PFISTER DIVERter CARTRIDGE FOR IMPERIAL



- Size 4-1/4"
- OEM ref#910-012/ 013/ 014/ 034

| PART# | DESCRIPTION |
|--------------|--------------|
| 21034 | For IMPERIAL |

PRICE PFISTER DIVERter CARTRIDGE FOR 2 & 3 VALVE, BEAUX



- Size 4-1/4"
- OEM ref#910-052

| PART# | DESCRIPTION |
|--------------|----------------------------|
| 21052 | For 2 & 3 valve, BEAUX ART |

PRICE PFISTER DIVERter CARTRIDGE FOR BEAUX ART



- For BEAUX ART RH STEM & BONNET
- Overall length 5-1/32"
- OEM ref#910043

| PART# | DESCRIPTION |
|--------------|---------------|
| 21043 | For BEAUX ART |

PRICE PFISTER SHOWER CARTRIDGE FOR COMTEMPERA, MARQUIS, VERVE, WINDSOR



- Overall length 5-9/16"

| PART# | DESCRIPTION |
|--------------|-------------------|
| 21374 | VERVE shower stem |

PRICE PFISTER DIVERter CARTRIDGE



- For COMTEMPRA, MARQUIS, VERVE
- Size 5-11/16"
- OEM ref#910-385

| PART# | DESCRIPTION |
|--------------|----------------------------------|
| 21385 | PRICE PFISTER diverter cartridge |

OEM (Original Equipment Manufacturer) numbers, registered / non registered trademarks, faucet name, and manufacturer listed above are supplied and listed for your reference only. All LynCar items are precision made and tested to the highest standards, by qualified factories inspected and approved by LynCar.

STERLING

STERLING TEMPO ACRYLIC HANDLES



- Hot / cold pair
- 2-1/8" height
- OEM ref#A8369

| PART# | DESCRIPTION |
|-------|---------------------------------------|
| 929 | STERLING TEMPO acrylic handles |
| 929Q | STERLING TEMPO acrylic handles - bulk |

STERLING STARFLO HANDLES



- Hot / cold pair
- Chrome plated metal lever
- 1-1/2" height
- OEM ref#A1926

| PART# | DESCRIPTION |
|-------|---------------------------------|
| 930 | STERLING STARFLO handles |
| 930Q | STERLING STARFLO handles - bulk |

STERLING METAL LOOP HANDLE USE FOR LAVATORY AND T/S



- 1-7/16" height
- OEM ref#A5043

| PART# | DESCRIPTION |
|--------|---------------|
| 11304 | Handle |
| 11304Q | Handle - bulk |

STERLING REPAIR KIT FOR KITCHEN FAUCETS



- OEM ref#A5020

| PART# | DESCRIPTION |
|--------|-------------------|
| 11302 | Repair kit |
| 11302Q | Repair kit - bulk |

STERLING REPAIR KIT FOR TUB & SHOWERS



- OEM ref#05010

| PART# | DESCRIPTION |
|--------|-------------------|
| 11303 | Repair kit |
| 11303Q | Repair kit - bulk |

STERLING REPLACEMENT SEATS



- Sold per pair
- 1/2" x 24 TPI
- OEM ref#99S0369

| PART# | DESCRIPTION |
|-------|--------------|
| 9480 | Seats |
| 9480Q | Seats - bulk |

OEM (Original Equipment Manufacturer) numbers, registered / non registered trademarks, faucet name, and manufacturer listed above are supplied and listed for your reference only. All LynCar items are precision made and tested to the highest standards, by qualified factories inspected and approved by LynCar.

STERLING

STERLING CARTRIDGE FOR KITCHEN & LAVATORY BRASS CARTRIDGE

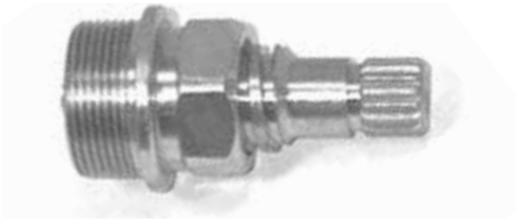

- OEM ref#A8153/54

| PART# | BULK PART# | DESCRIPTION |
|-------|------------|-------------|
| 924 | 924Q | Hot |
| 925 | 925Q | Cold |

STERLING CARTRIDGE FOR KITCHEN



- Plastic 2-1/2" height
 - With or without spray
 - OEM ref#A5013 / 5023

| PART# | BULK PART# | DESCRIPTION |
|-------|------------|-------------|
| 11300 | 11300Q | Less spray |
| 11305 | 11305Q | With spray |

STERLING TUB & SHOWER CARTRIDGE 4-1/2" HEIGHT



- OEM ref#A8105

| PART# | BULK PART# | DESCRIPTION |
|-------|------------|------------------------|
| 948 | 948Q | STERLING T/S cartridge |

STERLING TUB & SHOWER CARTRIDGE OLD STYLE, 4-1/2" HEIGHT



- OEM ref#A8106

| PART# | BULK PART# | DESCRIPTION |
|-------|------------|------------------------|
| 949 | 949Q | STERLING T/S cartridge |

STERLING TUB & SHOWER CARTRIDGES

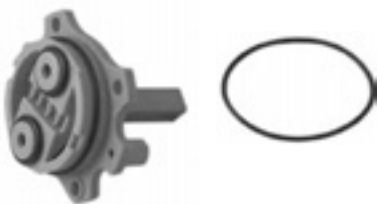

- OEM ref#05300 brass stem

| PART# | BULK PART# | DESCRIPTION |
|-------|------------|-------------|
| 11307 | 11307Q | Brass |

FAUCET REPAIR

OEM (Original Equipment Manufacturer) numbers, registered / non registered trademarks, faucet name, and manufacturer listed above are supplied and listed for your reference only. All LynCar items are precision made and tested to the highest standards, by qualified factories inspected and approved by LynCar.

SYMMONS

SYMMONS TRI CANOPY HANDLE FOR TEMPTROL



Handle & button

- Die cast metal
- OEM ref#T31

Index button for TRI CANOPY handle

- OEM ref#T33

| PART# | BULK PART# | DESCRIPTION |
|-------|------------|-----------------|
| 11326 | 11326Q | Handle & button |
| 11352 | 11352Q | Button only |

SYMMONS TRI CANOPY HANDLE FOR TEMPTROL II



- Die cast metal
- OEM ref#T65

| PART# | BULK PART# | DESCRIPTION |
|-------|------------|-----------------|
| 11342 | 11342Q | for TEMPTROL II |

SYMMONS HANDLE



- Crystal Handle for T&S for TEMPTROL

| PART# | BULK PART# | DESCRIPTION |
|-------|------------|-------------|
| 11328 | 11328Q | Handle |

SYMMONS DIVERTER HANDLE FOR TEMPTROL



- Die cast metal, comes with clip
- OEM ref#T30

| PART# | BULK PART# | DESCRIPTION |
|-------|------------|-------------|
| 11327 | 11327Q | Handle |

SYMMONS SAFETY MIX LEVER HANDLES DIE CAST METAL



- Tub and shower 1-1/2" height
- Kitchen lavatory 7/8" height
- OEM ref#R14

| PART# | BULK PART# | DESCRIPTION |
|-------|------------|-------------|
| 11341 | 11341Q | Small |
| 11337 | 11337Q | Large |

OEM (Original Equipment Manufacturer) numbers, registered / non registered trademarks, faucet name, and manufacturer listed above are supplied and listed for your reference only. All LynCar items are precision made and tested to the highest standards, by qualified factories inspected and approved by LynCar.

SYMMONS

SYMMONS THREADED DOME ESCUTCHEON



- For TEMPTRON
- OEM ref#T19 / T20

| PART# | BULK PART# | DESCRIPTION |
|--------------|---------------|-------------|
| 11353 | 11353Q | Escutcheon |

SYMMONS TEMPTRON HOT & COLD REMOVAL TOOLS



| PART# | DESCRIPTION |
|--------------|---------------|
| 11330 | Removal tools |

SYMMONS CARTRIDGE SPINDLE ASSEMBLY FOR TEMPTRON



- Length 4-7/16"
- OEM ref#TA10

| PART# | BULK PART# | DESCRIPTION |
|--------------|---------------|------------------|
| 11333 | 11333Q | Spindle assembly |

SYMMONS CARTRIDGE SPINDLE ASSEMBLY FOR SAFETY MIX



- Length 5-1/16"
- OEM ref#C5

| PART# | BULK PART# | DESCRIPTION |
|--------------|---------------|------------------|
| 11335 | 11335Q | Spindle assembly |

SYMMONS DIVERTER ASSEMBLY FOR TEMPTRON



- Length 2-3/8"
- OEM ref#TA-25A

| PART# | BULK PART# | DESCRIPTION |
|--------------|---------------|-------------------|
| 11354 | 11354Q | Diverter assembly |

SYMMONS CARTRIDGE SPINDLE ASSEMBLY FOR SAFETY MIX



- Washer kit for SAFETYMIX OEM ref#Kit B
- Washer kit for TEMPTRON OEM ref#TA9
- Seat repair kit TEMPTRON OEM ref#T4

| PART# | DESCRIPTION |
|--------------|--------------------------|
| 11334 | Washer kit for SAFETYMIX |
| 11344 | Washer kit for TEMPTRON |
| 11343 | Seat repair kit TEMPTRON |

FAUCET REPAIR

OEM (Original Equipment Manufacturer) numbers, registered / non registered trademarks, faucet name, and manufacturer listed above are supplied and listed for your reference only. All LynCar items are precision made and tested to the highest standards, by qualified factories inspected and approved by LynCar.

T&S BRASS

**T&S FAUCET STEM
HOT OR COLD**



- Stems for ETERNA cartridge from T&S

**T&S CARTRIDGE ASSEMBLY FOR
ETERNA, INCLUDES BONNET**



- OEM ref#002714-40 Hot
- OEM ref#002713-40 Cold

| PART# | BULK PART# | DESCRIPTION |
|-------|------------|-------------|
| 33074 | 33074Q | Hot |
| 33073 | 33073Q | Cold |

| PART# | DESCRIPTION |
|-------|-------------|
| 33076 | Hot |
| 33075 | Cold |

**T&S CARTRIDGE INSERT FOR
ETERNA**



- OEM ref#1000788-20 (Hot)
- OEM ref#1000789-20 (Cold)

**T&S CARTRIDGE ASSEMBLY FOR
HOT SPRING, INCLUDES BONNET**



- OEM ref#002712-40 (Hot)
- OEM ref#002711-40 (Cold)

| PART# | BULK PART# | DESCRIPTION |
|-------|------------|-------------|
| 33078 | 33078Q | Hot |
| 33077 | 33077Q | Cold |

| PART# | DESCRIPTION |
|-------|-------------|
| 33080 | Hot |
| 33079 | Cold |

**T&S CARTRIDGE PRE RINSE SPRAY
FITS SPRAY ASSEMBLY & PEDAL
VALVES**



- OEM ref#002856-40

**T&S METERING CARTRIDGE &
HANDLE**



- OEM ref#0238AB

| PART# | DESCRIPTION |
|-------|-------------------------------|
| 33019 | T&S cartridge pre rinse spray |

| PART# | DESCRIPTION |
|-------|---------------------------------|
| 33081 | T&S metering cartridge & handle |

OEM (Original Equipment Manufacturer) numbers, registered / non registered trademarks, faucet name, and manufacturer listed above are supplied and listed for your reference only. All LynCar items are precision made and tested to the highest standards, by qualified factories inspected and approved by LynCar.

FAUCET REPAIR

VALLEY

VALLEY SINGLE LEVER HANDLE



- Crystal OEM ref#V6904
- Acrylic handle or die cast metal

VALLEY CHROME PLASTIC DOME HANDLES HOT/COLD



- Hot / cold pair
- OEM ref#V7804

| PART# | DESCRIPTION | PART# | BULK PART# | DESCRIPTION |
|-------|-------------|-------|------------|----------------|
| 7063 | Crystal | 7069 | 7069Q | Chrome plastic |
| 11304 | Metal | | | |

VALLEY CARTRIDGE FOR LAV, KITCHEN



- Single lever faucets
- OEM ref#V6680

VALLEY METAL SINGLE LEVER HANDLES



- Old Style OEM ref# V1165
- New Style OEM ref#VP1989

| PART# | BULK PART# | DESCRIPTION | PART# | STYLE |
|-------|------------|-------------|-------|-------|
| 7050 | 7050Q | Cartridge | 7066 | Old |
| | | | 7067 | New |

VALLEY CARTRIDGE FOR TWO HANDLE FAUCETS



- Cartridge can be used for hot or cold
- OEM ref#V6804

VALLEY CARTRIDGE LEVER FAUCETS WITH/WITHOUT DIVERTER



| PART# | BULK PART# | DESCRIPTION | PART# | BULK PART# | DIVERTER |
|-------|------------|-------------|-------|------------|----------|
| 7052 | 7052Q | Cartridge | 7056 | 7056Q | No |
| | | | 7057 | 7057Q | Yes |

FAUCET REPAIR

OEM (Original Equipment Manufacturer) numbers, registered / non registered trademarks, faucet name, and manufacturer listed above are supplied and listed for your reference only. All LynCar items are precision made and tested to the highest standards, by qualified factories inspected and approved by LynCar.

WALLACEBURG

**WALLACEBURG CARTRIDGE
FOR OLD STYLE DECK FAUCETS**



- Hot or cold
- 2" height
- OEM ref#W3242

| PART# | BULK PART# | DESCRIPTION |
|-------|------------|-------------|
| 939 | 939Q | Hot |
| 940 | 940Q | Cold |

**WALLACEBURG CARTRIDGE FOR CENTRESETS
AND TUB & SHOWER**



- Hot or cold
- OEM ref#W3242

| PART# | BULK PART# | DESCRIPTION |
|-------|------------|-------------|
| 941 | 941Q | Hot |
| 942 | 942Q | Cold |

**WALLACEBURG DIVERTER FOR TUB & SHOWER
JUBILEE 1950 TO 1968**

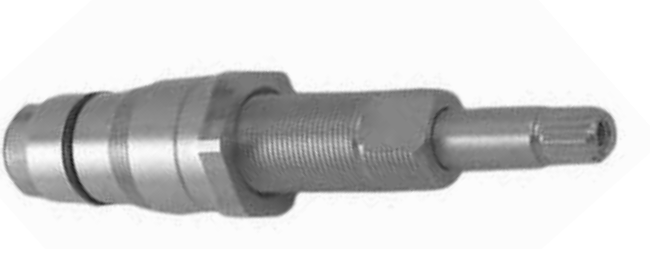

- Height 4-3/4"
- OEM ref#T3773

| PART# | BULK PART# | DESCRIPTION |
|-------|------------|-------------|
| 9390 | 9390Q | Diverter |

**WALLACEBURG DIVERTER FOR TUB & SHOWER JUBILEE
1950 TO 1968**



- Height 4-7/8"
- OEM ref#T3775

| PART# | BULK PART# | DESCRIPTION |
|-------|------------|-------------|
| 9391 | 9391Q | Diverter |

OEM (Original Equipment Manufacturer) numbers, registered / non registered trademarks, faucet name, and manufacturer listed above are supplied and listed for your reference only. All LynCar items are precision made and tested to the highest standards, by qualified factories inspected and approved by LynCar.

FAUCET REPAIR

WALTEC

WALTEC HANDLES CROWN NEW STYLE



- Hot / cold pair
- CP Die Cast

WALTEC HANDLE LEVER



- Hot / cold pair
- New style lever handle for faucets
- Chrome plastic
- Inserts included
- OEM ref#76923

| PART# | BULK PART# | DESCRIPTION |
|-------|------------|---------------|
| 2050 | 2050Q | CROWN handles |

| PART# | BULK PART# | DESCRIPTION |
|-------|------------|---------------|
| 2055 | 2055Q | Lever handles |

WALTEC HANDLES FLOTROL STYLE CP PLASTIC



- Hot / cold pair
- CP plastic
- OEM ref#76540

WALTEC HANDLES FLOTROL STYLE METAL



- Hot / cold pair
- Die cast metal
- OEM ref#76540

| PART# | BULK PART# | DESCRIPTION |
|-------|------------|-------------|
| 2008 | 2008Q | Plastic |

| PART# | BULK PART# | DESCRIPTION |
|-------|------------|-------------|
| 2009 | 2009Q | Metal |

WALTEC HANDLES FLOTROL STYLE, LEVER



- Hot / cold pair
- CP plastic
- OEM ref#76570

WALTEC HANDLES STARBURST STYLE



- Hot / cold pair
- CP plastic
- OEM ref#76519

| PART# | BULK PART# | DESCRIPTION |
|-------|------------|----------------|
| 2007 | 2007Q | Lever, FLOTROL |

| PART# | BULK PART# | DESCRIPTION |
|-------|------------|-------------|
| 953 | 953Q | STARBURST |

OEM (Original Equipment Manufacturer) numbers, registered / non registered trademarks, faucet name, and manufacturer listed above are supplied and listed for your reference only. All LynCar items are precision made and tested to the highest standards, by qualified factories inspected and approved by LynCar.

WALTEC

WALTEC CARTRIDGE OLD STYLE (PRIOR TO 1990)



- Height 1-3/4
- OEM ref#76100 hot
- OEM ref#76101 cold

| PART# | BULK PART# | DESCRIPTION |
|-------|------------|-------------|
| 901 | 901Q | Hot |
| 902 | 902Q | Cold |

WALTEC CARTRIDGE NEW STYLE



- Height 1-3/4"
- OEM ref#96100 hot
- OEM ref#96101 cold

| PART# | BULK PART# | DESCRIPTION |
|-------|------------|-------------|
| 910 | 910Q | Hot |
| 911 | 911Q | Cold |

WALTEC CARTRIDGE PIONEER STYLE



- OEM ref#76763 hot
- OEM ref#76764 cold

| PART# | BULK PART# | DESCRIPTION |
|-------|------------|-------------|
| 945 | 945Q | Hot |
| 946 | 946Q | Cold |

WALTEC EXTENDED SEATS FOR TUB & SHOWER AND AUTO WASH



- 9/16 x 24 TPI x 1-1/2" long
- Chrome plated
- OEM ref#16392

| PART# | BUPART# | DESCRIPTION |
|-------|---------|----------------|
| 9478 | 9478Q | Extended seats |

WALTEC SEAT ALSO FITS WALLACEBURG



- 9/16 x 24 TPI
- OEM ref#16500

| PART# | BULK PART# | DESCRIPTION |
|-------|------------|-------------|
| 947 | 947Q | Seat |

OEM (Original Equipment Manufacturer) numbers, registered / non registered trademarks, faucet name, and manufacturer listed above are supplied and listed for your reference only. All LynCar items are precision made and tested to the highest standards, by qualified factories inspected and approved by LynCar.

WALTEC

WALTEC DIVERTER FOR STARBURST AND FLOTROL 4-1/4"



- Concealed tub & shower
- 4-1/4" long
- OEM ref#76655

| PART# | BULK PART# | DESCRIPTION |
|-------|------------|-------------|
| 938 | 938Q | Diverter |

WALTEC DIVERTER FLOTROL TUB & SHOWER 4-7/8"



- 1970 -1973
- 4-7/8" long
- OEM ref#T25168

| PART# | BULK PART# | DESCRIPTION |
|-------|------------|-------------|
| 964 | 964Q | Diverter |

WALTEC DIVERTER ASSEMBLY FOR STARBURST AND FLOTROL 2-5/8"



- Facemount tub & shower
- 2-5/8" long
- OEM ref#76305

| PART# | BULK PART# | DESCRIPTION |
|-------|------------|-------------------|
| 951 | 951Q | Diverter assembly |

WALTEC DIVERTER ASSEMBLY FOR STARBURST AND FLOTROL 2-3/4"



- Facemount tub & shower
- 2-3/4" long
- OEM ref#76341

| PART# | BULK PART# | DESCRIPTION |
|-------|------------|-------------------|
| 952 | 952Q | Diverter assembly |

OEM (Original Equipment Manufacturer) numbers, registered / non registered trademarks, faucet name, and manufacturer listed above are supplied and listed for your reference only. All LynCar items are precision made and tested to the highest standards, by qualified factories inspected and approved by LynCar.

FAUCET REPAIR

SPOUTS

**BELANGER KITCHEN DECK SPOUT
8" NEW STYLE AFTER 2005**



| PART# | BULK PART# | DESCRIPTION |
|-------|------------|--------------------|
| 1173 | 1173Q | 8" spout new style |

**KITCHEN SPOUT FOR CUTHBERT
/BELANGER 8" OLD STYLE BEFORE
2005**



| PART# | BULK PART# | DESCRIPTION |
|-------|------------|--------------------|
| 1174 | 1174Q | 8" spout old style |

**DELTA DECK SPOUT 8" FOR SINGLE
LEVER FAUCETS**



- OEM ref#RP-5654

| PART# | BULK PART# | DESCRIPTION |
|-------|------------|-------------|
| 12832 | 12832Q | 8" spout |

**EMCO KITCHEN REPLACEMENT
DECK SPOUT 8" SPOUT FOR
DORIC & CORONA DECK FAUCETS**



- OEM ref#51-1931005

| PART# | BULK PART# | DESCRIPTION |
|-------|------------|-------------|
| 1161 | 1161Q | 8" spout |

**MOEN REPLACEMENT DECK SPOUT
FITS CHATEAU SINGLE LEVER MODELS**



- OEM ref#7200 / 7500

| PART# | BULK PART# | DESCRIPTION |
|-------|------------|------------------|
| 12831 | 12831Q | Replacement deck |

**FAUCET DECK SPOUTS FOR
MUELLER AND STERLING**



- 8" spouts

| PART# | BULK PART# | DESCRIPTION |
|-------|------------|--------------|
| 1164 | 1164Q | For MUELLER |
| 1165 | 1165Q | For STERLING |

**WALTEC 8" HIGHRISE DECK SPOUT
FITS MOST WALTEC PRODUCTS**



- Metal snap ring before 1977
- Nylon snap ring since 1977
- OEM ref#76363

| PART# | BULK PART# | DESCRIPTION |
|-------|------------|-------------|
| 1162 | 1162Q | Metal Ring |
| 1163 | 1163Q | Nylon Ring |

**WALTEC 8" NEW STYLE DECK SPOUT
FITS MOST WALTEC PRODUCTS
SINCE 1977**



- OEM ref#76541-1

| PART# | BULK PART# | DESCRIPTION |
|-------|------------|--------------|
| 1172 | 1172Q | 8" new style |

OEM (Original Equipment Manufacturer) numbers, registered / non registered trademarks, faucet name, and manufacturer listed above are supplied and listed for your reference only. All LynCar items are precision made and tested to the highest standards, by qualified factories inspected and approved by LynCar.

O-RING KITS

O - RING KIT 200 PIECES



| PART# | | DESCRIPTION | | | |
|-------|-------|---------------------------------------|------|-----|--|
| 2250 | | 200 pc "o" ring kit contains 12 sizes | | | |
| Item | ID | OD | DIA | PCS | |
| 44006 | 1/4 | 3/8 | 1/16 | 25 | |
| 44008 | 5/16 | 7/16 | 1/16 | 25 | |
| 44026 | 3/8 | 9/16 | 3/32 | 40 | |
| 44028 | 7/16 | 5/8 | 3/32 | 20 | |
| 44030 | 1/2 | 11/16 | 3/32 | 20 | |
| 44032 | 9/16 | 3/4 | 3/32 | 10 | |
| 44034 | 5/8 | 13/16 | 3/32 | 10 | |
| 44036 | 11/16 | 7/8 | 3/32 | 10 | |
| 44038 | 3/4 | 15/16 | 3/32 | 10 | |
| 44050 | 3/4 | 1 | 1/8 | 10 | |
| 44052 | 13/16 | 1-1/16 | 1/8 | 10 | |
| 44054 | 7/8 | 1-1/8 | 1/8 | 10 | |

O-RING KIT - 500 PIECES



| PART# | | DESCRIPTION | | | |
|-------|--------|---|------|-----|--|
| 2252 | | 500 pc "o" ring kit contains 20 sizes plus 2oz faucet grease & o ring pick. | | | |
| Item | ID | OD | DIA | PCS | |
| 44002 | 5/32 | 9/32 | 1/16 | 40 | |
| 44006 | 1/4 | 3/8 | 1/16 | 40 | |
| 44008 | 5/16 | 7/16 | 1/16 | 40 | |
| 44010 | 3/8 | 1/2 | 1/16 | 35 | |
| 44012 | 7/16 | 9/16 | 1/16 | 35 | |
| 44014 | 1/2 | 5/8 | 1/16 | 35 | |
| 44024 | 1-3/8 | 1-1/2 | 1/16 | 15 | |
| 44026 | 3/8 | 9/16 | 3/32 | 40 | |
| 44028 | 7/16 | 5/8 | 3/32 | 35 | |
| 44030 | 1/2 | 11/16 | 3/32 | 35 | |
| 44032 | 9/16 | 3/4 | 3/32 | 35 | |
| 44034 | 5/8 | 13/16 | 3/32 | 20 | |
| 44036 | 11/16 | 7/8 | 3/32 | 20 | |
| 44038 | 3/4 | 15/16 | 3/32 | 20 | |
| 44040 | 13/16 | 1 | 3/32 | 15 | |
| 44044 | 1-5/16 | 1-1/2 | 3/32 | 10 | |
| 44052 | 13/16 | 1-1/16 | 1/8 | 10 | |
| 44054 | 7/8 | 1-1/8 | 1/8 | 10 | |
| 44066 | 1-1/4 | 1-1/2 | 1/8 | 5 | |
| 44068 | 1-5/16 | 1-9/16 | 1/8 | 5 | |

FAUCET REPAIR

O-RINGS

O-RINGS - 1/16" THICK

Actual Size Selection Chart - 1/16" Thick

- The most popular o rings used in the plumbing industry
- Order by bags of 100 or mini packs of 25 pcs

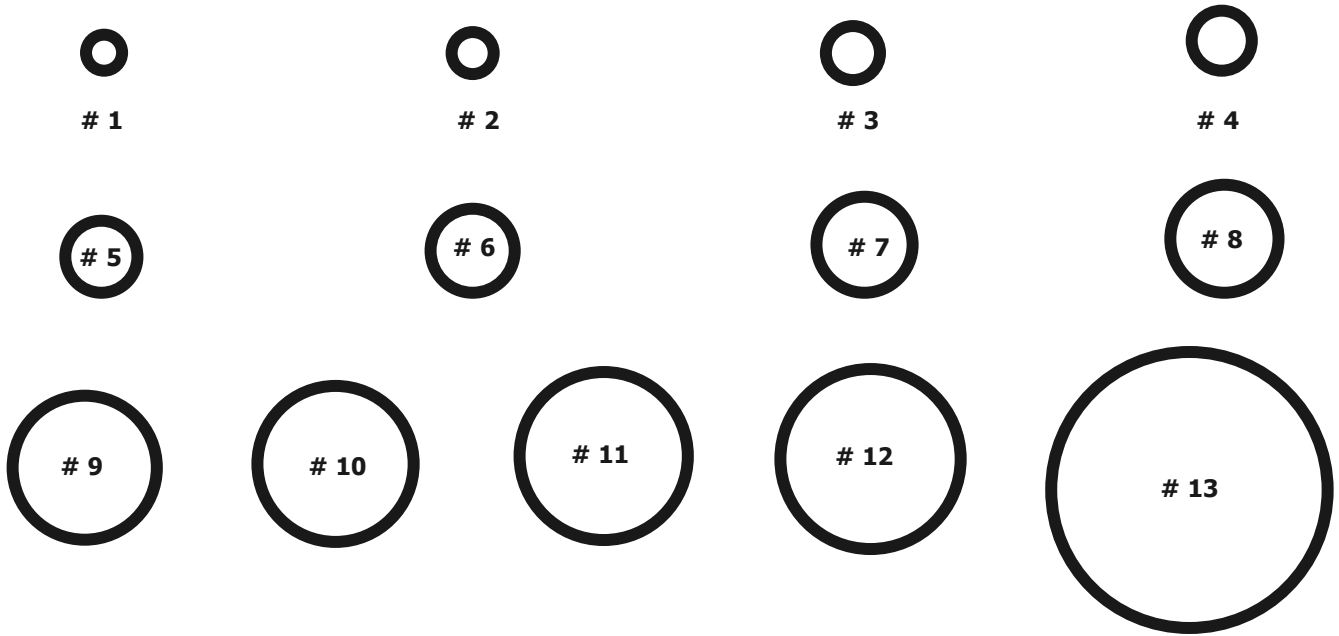

| 25 PK PART# | BULK PART# | PLANOGRAM | ID | OD | DIA | USED FOR |
|-------------|------------|-----------|-------|-------|------|--------------------------------|
| 44000 | 44000Q | 1 | 1/8 | 1/4 | 1/16 | |
| 44002 | 44002Q | 2 | 5/32 | 9/32 | 1/16 | CUTHBERT |
| 44004 | 44004Q | 3 | 7/32 | 11/32 | 1/16 | |
| 44006 | 44006Q | 4 | 1/4 | 3/8 | 1/16 | CUTHBERT, EMCO |
| 44008 | 44008Q | 5 | 5/16 | 7/16 | 1/16 | CUTHBERT, MUELLER, WALLACEBURG |
| 44010 | 44010Q | 6 | 3/8 | 1/2 | 1/16 | WALTEC |
| 44012 | 44012Q | 7 | 7/16 | 9/16 | 1/16 | EMCO, WALLACEBURG |
| 44014 | 44014Q | 8 | 1/2 | 5/8 | 1/16 | CUTHBERT |
| 44016 | 44016Q | 9 | 11/16 | 13/16 | 1/16 | WALLACEBURG |
| 44018 | 44018Q | 10 | 3/4 | 7/8 | 1/16 | WALTEC |
| 44020 | 44020Q | 11 | 13/16 | 15/16 | 1/16 | |
| 44022 | 44022Q | 12 | 7/8 | 1 | 1/16 | |
| 44024 | 44024Q | 13 | 1-3/8 | 1-1/2 | 1/16 | |

O-RINGS

D

O-RINGS - 3/32" THICK

Actual Size Selection Chart - 3/32" Thick

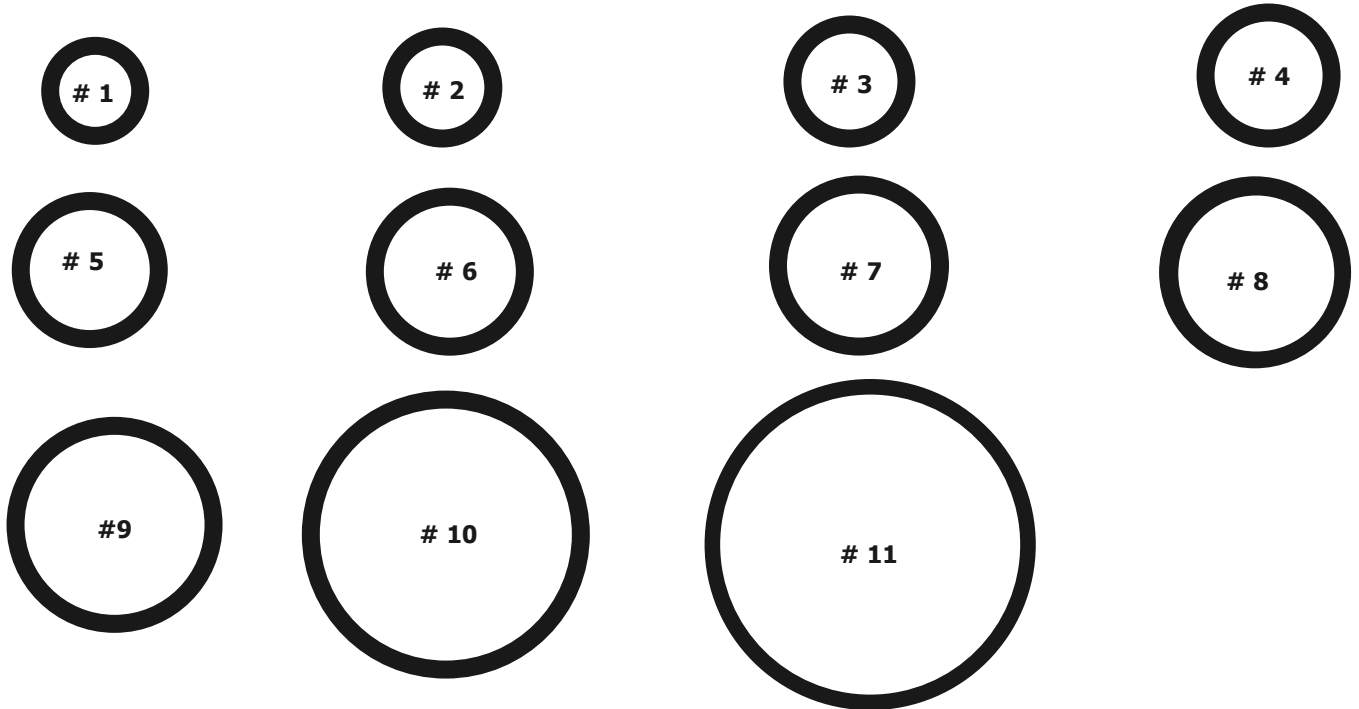

FAUCET REPAIR

| 25 PK PART# | BULK PART# | PLANOGRAM | ID | OD | DIA | USED FOR |
|-------------|------------|-----------|--------|-------|------|---|
| 44026 | 44026Q | 1 | 3/8 | 9/16 | 3/32 | CRANE, EMCO, CUTHBERT, JAMECO, STERLING, GALTMASTER, WALTEC |
| 44028 | 44028Q | 2 | 7/16 | 5/8 | 3/32 | EMCO, WALTEC |
| 44030 | 44030Q | 3 | 1/2 | 11/16 | 3/32 | |
| 44032 | 44032Q | 4 | 9/16 | 3/4 | 3/32 | EMCO, MOEN, WALTEC |
| 44034 | 44034Q | 5 | 5/8 | 13/16 | 3/32 | MOEN, GALTMASTER, WALTEC |
| 44036 | 44036Q | 6 | 11/16 | 7/8 | 3/32 | |
| 44038 | 44038Q | 7 | 3/4 | 15/16 | 3/32 | |
| 44040 | 44040Q | 8 | 13/16 | 1 | 3/32 | EMCO |
| 44042 | 44042Q | 9 | 15/16 | 1-1/8 | 3/32 | |
| 44044 | 44044Q | 10 | 1-5/16 | 1-1/2 | 3/32 | |
| 44046 | 44046Q | 11 | 1-9/16 | 1-3/4 | 3/32 | |

O-RINGS

O-RINGS - 1/8" THICK

Actual Size Selection Chart - 1/8" Thick

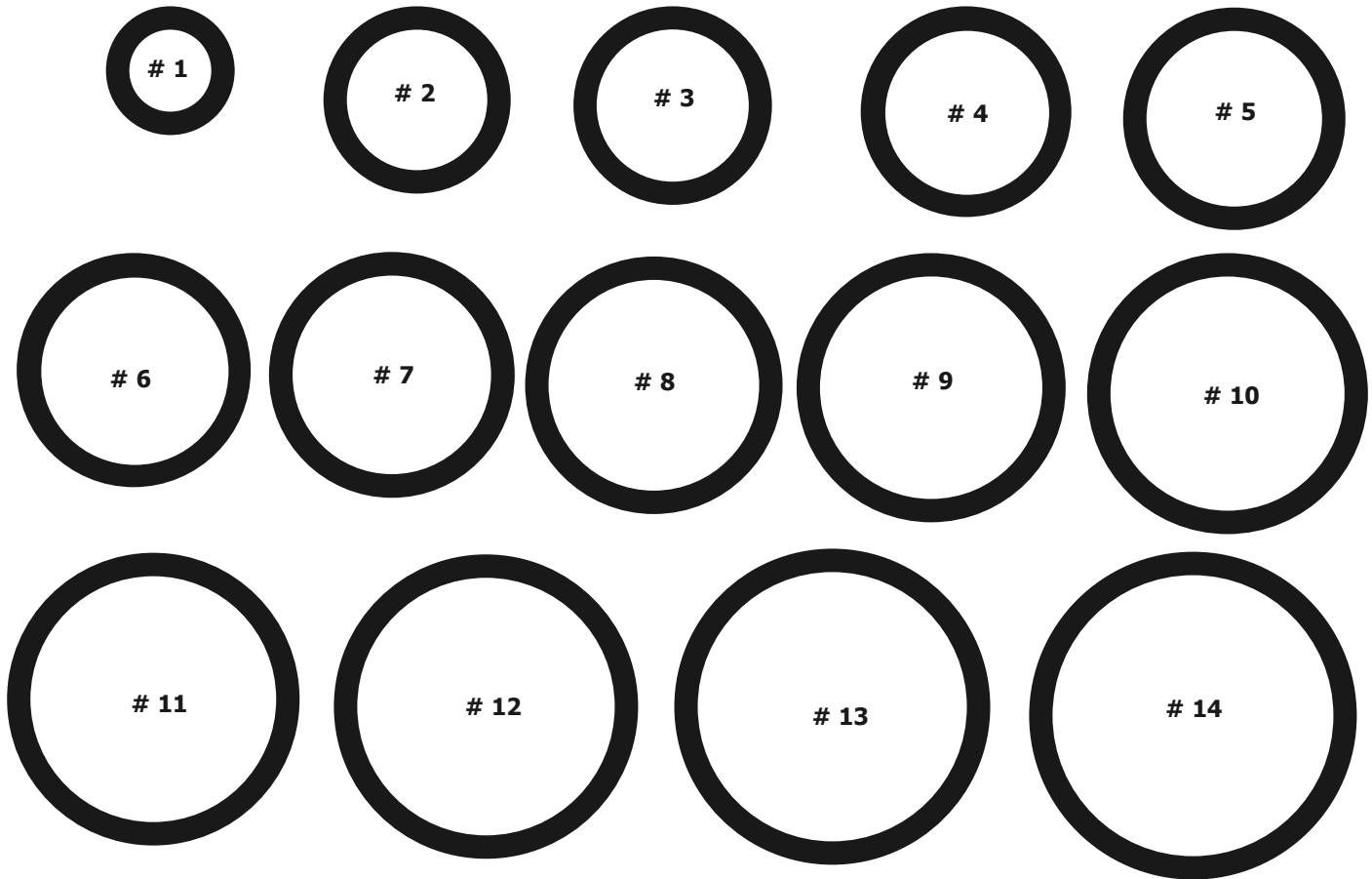

FAUCET REPAIR

| 25 PK PART# | BULK PART# | PLANOGRAM | ID | OD | DIA |
|-------------|------------|-----------|--------|---------|-----|
| 44048 | 44048Q | 1 | 7/16 | 11/16 | 1/8 |
| 44050 | 44050Q | 2 | 3/4 | 1 | 1/8 |
| 44052 | 44052Q | 3 | 13/16 | 1-1/16 | 1/8 |
| 44054 | 44054Q | 4 | 7/8 | 1-1/8 | 1/8 |
| 44056 | 44056Q | 5 | 15/16 | 1-3/16 | 1/8 |
| 44058 | 44058Q | 6 | 1 | 1-1/4 | 1/8 |
| 44060 | 44060Q | 7 | 1-1/16 | 1-5/16 | 1/8 |
| 44062 | 44062Q | 8 | 1-1/8 | 1-3/8 | 1/8 |
| 44064 | 44064Q | 9 | 1-3/16 | 1-7/16 | 1/8 |
| 44066 | 44066Q | 10 | 1-1/4 | 1-1/2 | 1/8 |
| 44068 | 44068Q | 11 | 1-5/16 | 1-9/16 | 1/8 |
| 44070 | 44070Q | 12 | 1-3/8 | 1-5/8 | 1/8 |
| 44072 | 44072Q | 13 | 1-7/16 | 1-11/16 | 1/8 |
| 44074 | 44074Q | 14 | 1-1/2 | 1-3/4 | 1/8 |

O-RINGS

D

O-RINGS - 3/16" THICK

Actual Size Selection Chart - 3/16" Thick

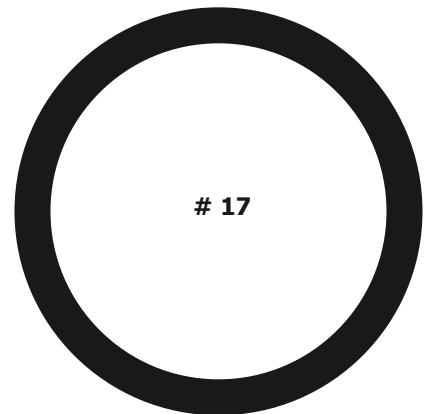
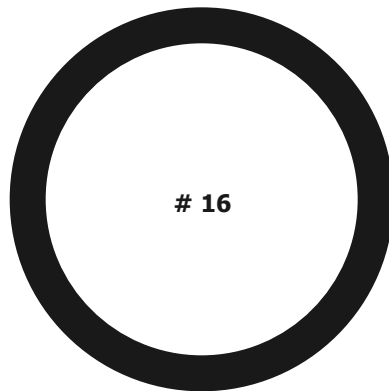
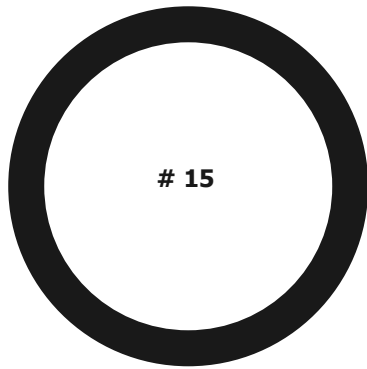

FAUCET REPAIR

| 25 PK PART# | BULK PART# | PLANOGRAM | ID | OD | DIA |
|-------------|------------|-----------|-------|-------|------|
| 44076 | 44076Q | 15 | 1-1/2 | 1-7/8 | 3/16 |
| 44078 | 44078Q | 16 | 1-5/8 | 2 | 3/16 |
| 44080 | 44080Q | 17 | 1-3/4 | 2-1/8 | 3/16 |

FAUCET REPAIR

STEM GREASE



- Specially formulated for use on all metal faucets and valve stems carrying air, steam, and hot or cold water.
- Also lubricates ball cocks, plungers, packings and washers
- Can be used on potable water since it is safe and nontoxic

| PART# | DESCRIPTION |
|-------|-------------|
| 3155 | Stem grease |

O-RING PICK



| PART# | DESCRIPTION |
|-------|-------------|
| 5200 | O-Ring pick |

KORKY EASYSORT COLOURED FAUCET WASHERS



- KORKY coloured premium faucet washers
- Many sizes available
- Sold in retail pack, 6 pieces or bulk

| FLAT PART# | | BEVELED PART# | | O.D. | TRADE DESCRIPTION | COLOUR |
|------------|--------|---------------|--------|--------|-------------------|-------------|
| 6 PK | BULK | 6 PK | BULK | | | |
| 12530 | 12530Q | 12541 | 12541Q | 1/2" | 00 | Dark brown |
| 12531 | 12531Q | 12542 | 12542Q | 17/32" | 0 | Dark blue |
| 12532 | 12532Q | 12543 | 12543Q | 9/16" | 1/4 | Dark green |
| 12533 | 12533Q | 12544 | 12544Q | 19/32" | 1/4L | Dark purple |
| 12534 | 12534Q | 12545 | 12545Q | 5/8" | 3/8 | Grey |
| 12535 | 12535Q | 12546 | 12546Q | 21/32" | 3/8M | Violet |
| 12536 | 12536Q | 12547 | 12547Q | 11/16" | 3/8L | Orchid |
| 12537 | 12537Q | 12548 | 12548Q | 3/4" | 1/2 | Hot pink |
| 12538 | 12538Q | | | 25/32" | 1/2L | Teal |
| 12539 | 12539Q | 12555 | 12555Q | 13/16" | 5/8 | Yellow |
| 12553 | 12553Q | | | 29/32" | 5/8L | Light blue |

BIBB WASHER KITS

FLAT WASHER KITS



- Flat washer kit
- 225 pieces
- LYNCAR black washers or KORXY premium coloured washers available

| PART# | | | DESCRIPTION | | | PART# | | | DESCRIPTION | | |
|--------------|------|-----|---------------------------------------|------------|------|--------------|--------------|-------------|--|-----|--|
| 2254 | | | 225 pcs, flat washer black 9 sizes | | | 2254K | | | 225 pcs, flat washer KORXY colour 9 sizes | | |
| Item | Size | Pcs | Item | Colour | Size | Pcs | Item | Colour | Size | Pcs | |
| 12500 | 00 | 35 | 12530 | Dark Brown | 00 | 35 | 12531 | Dark Blue | 0 | 35 | |
| 12501 | 0 | 35 | 12532 | Dark Green | 1/4 | 35 | 12533 | Dark Purple | 1/4L | 25 | |
| 12502 | 1/4 | 35 | 12534 | Grey | 3/8 | 25 | 12535 | Violet | 3/8M | 25 | |
| 12503 | 1/4L | 25 | 12536 | Orchid | 3/8L | 15 | 12537 | Hot Pink | 1/2 | 15 | |
| 12504 | 3/8 | 25 | 12539 | Yellow | 5/8 | 15 | | | | | |
| 12505 | 3/8M | 25 | | | | | | | | | |
| 12506 | 3/8L | 15 | | | | | | | | | |
| 12507 | 1/2 | 15 | | | | | | | | | |
| 12509 | 5/8 | 15 | | | | | | | | | |

BEVELED WASHER KITS



- Beveled washer kit
- 215 pieces
- LYNCAR black washers or KORXY premium coloured washers available

| PART# | | | DESCRIPTION | | | PART# | | | DESCRIPTION | | |
|--------------|------|-----|--|------------|------|--------------|--------------|-------------|---|-----|--|
| 2256 | | | 215 pcs beveled washer black 9 sizes | | | 2256K | | | 215 pcs beveled washer KORXY colour 9 sizes | | |
| Item | Size | Pcs | Item | Colour | Size | Pcs | Item | Colour | Size | Pcs | |
| 12511 | 00 | 30 | 12541 | Dark Brown | 00 | 30 | 12542 | Dark Blue | 0 | 30 | |
| 12512 | 0 | 30 | 12543 | Dark Green | 1/4 | 30 | 12544 | Dark Purple | 1/4L | 25 | |
| 12513 | 1/4 | 30 | 12545 | Grey | 3/8 | 25 | 12546 | Violet | 3/8M | 20 | |
| 12514 | 1/4L | 25 | 12547 | Orchid | 3/8L | 30 | 12548 | Hot Pink | 1/2 | 15 | |
| 12515 | 3/8 | 25 | 12555 | Yellow | 5/8 | 10 | | | | | |
| 12516 | 3/8M | 20 | | | | | | | | | |
| 12517 | 3/8L | 30 | | | | | | | | | |
| 12518 | 1/2 | 15 | | | | | | | | | |
| 12520 | 5/8 | 10 | | | | | | | | | |

BIBB & HANDLE

WASHER BIBB



| FLAT PART# | | BEVELED PART# | | TRADE DESCRIPTION | O.D. |
|------------|--------|---------------|--------|-------------------|--------|
| 6 PK | BULK | 6 PK | BULK | | |
| 12500 | 12500Q | 12511 | 12511Q | 00 | 1/2" |
| 12501 | 12501Q | 12512 | 12512Q | 0 | 17/32" |
| 12502 | 12502Q | 12513 | 12513Q | 1/4 | 9/16" |
| 12503 | 12503Q | 12514 | 12514Q | 1/4L | 19/32" |
| 12504 | 12504Q | 12515 | 12515Q | 3/8 | 5/8" |
| 12505 | 12505Q | 12516 | 12516Q | 3/8M | 21/32" |
| 12506 | 12506Q | 12517 | 12517Q | 3/8L | 11/16" |
| 12507 | 12507Q | 12518 | 12518Q | 1/2 | 3/4" |
| 12508 | 12508Q | 12519 | 12519Q | 1/2L | 25/32" |
| 12509 | 12509Q | 12520 | 12520Q | 5/8 | 13/16" |
| 12510 | 12510Q | 12521 | 12521Q | 5/8L | 29/32" |

SCREW - BULK BIBB & HANDLE SCREWS



| 25 PK PART# | BULK PART# | DESCRIPTION | HEAD |
|-------------|------------|--------------|---------|
| 13300 | 13300Q | 1/4" x 8-32 | Round |
| 13302 | 13302Q | 3/8" x 10-32 | Oval |
| 13304 | 13304Q | 1/2" x 10-24 | Oval |
| 13306 | 13306Q | 1/2" x 10-24 | Truss |
| 13308 | 13308Q | 1/2" x 8-32 | Binding |
| 13310 | 13310Q | 1/2" x 8-32 | Oval |
| 13312 | 13312Q | 1/2" x 8-32 | Truss |
| 13314 | 13314Q | 3/4" x 10-24 | Oval |
| 13316 | 13316Q | 3/4" x 10-32 | Oval |
| 13318 | 13318Q | 3/4" x 8-32 | Oval |
| 13320 | 13320Q | 3/4" x 10-32 | Binding |
| 13322 | 13322Q | 3/4" x 10-24 | Round |
| 13324 | 13324Q | 5/8" x 10-24 | Oval |
| 13326 | 13326Q | 1" x 10-24 | Truss |
| 13328 | 13328Q | 1" x 10-32 | Truss |

SCREW - BIBB & HANDLE SCREWS



| 25 PK PART# | BULK PART# | DESCRIPTION |
|-------------|------------|---------------|
| 13334 | 13334Q | 3/8" x 8-32 |
| 13335 | 13335Q | 1/2" x 8-32 |
| 13336 | 13336Q | 3/8" x 10-32 |
| 13337 | 13337Q | 1/2" x 10-32 |
| 13338 | 13338Q | 3/8" x 10 -24 |
| 13339 | 13339Q | 1/2" x 10-24 |

SIZING GAUGES

D

SEAT GAUGE



HANDLE GAUGE



| PART# | DESCRIPTION | PART# | DESCRIPTION |
|-------|--------------------|-------|----------------------|
| 11320 | Faucet seats gauge | 11321 | Faucet handles gauge |

AERATOR GAUGE



STEM GAUGE



| PART# | DESCRIPTION | PART# | DESCRIPTION |
|-------|----------------|-------|--------------------|
| 11322 | Aerators gauge | 11325 | Faucet stems gauge |

FAUCET REPAIR

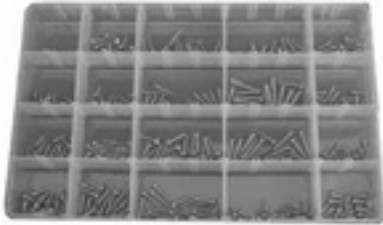
D **SCREW - BIBB & HANDLE KITS****HANDLE & BIBB SCREW KIT**

| PART# | DESCRIPTION | | | |
|-------|---------------------------------|--------------|---------|-----|
| 13330 | 300 pcs handle & bibb screw kit | | | |
| PART# | Use | Size | Head | Pcs |
| 13300 | Handle screw | 1/4" x 8-32 | Round | 15 |
| 13302 | Handle screw | 3/8" x 10-32 | Oval | 15 |
| 13304 | Handle screw | 1/2" x 10-24 | Oval | 15 |
| 13306 | Handle screw | 1/2" x 10-24 | Truss | 15 |
| 13308 | Handle screw | 1/2" x 8-32 | Binding | 15 |
| 13310 | Handle screw | 1/2" x 8-32 | Oval | 15 |
| 13312 | Handle screw | 1/2" x 8-32 | Truss | 15 |
| 13314 | Handle screw | 3/4" x 10-24 | Oval | 15 |
| 13316 | Handle screw | 3/4" x 10-32 | Oval | 15 |
| 13318 | Handle screw | 3/4" x 8-32 | Oval | 15 |
| 13320 | Handle screw | 3/4" x 10-32 | Binding | 15 |
| 13322 | Handle screw | 3/4" x 10-24 | Round | 15 |
| 13324 | Handle screw | 5/8" x 10-24 | Oval | 15 |
| 13326 | Handle screw | 1" x 10-24 | Truss | 15 |
| 13328 | Handle screw | 1" x 10-32 | Truss | 15 |
| 13334 | Bibb screw | 3/8" x 8-32 | Oval | 15 |
| 13335 | Bibb screw | 1/2" x 8-32 | Oval | 15 |
| 13337 | Bibb screw | 3/8" x 10-32 | Oval | 15 |
| 13338 | Bibb screw | 1/2" x 10-32 | Oval | 15 |
| 13339 | Bibb screw | 3/8" x 10-24 | Oval | 15 |

BIBB SCREW KIT

| PART# | DESCRIPTION | | |
|-------|-----------------------|--------------|-----|
| 13332 | 150 pc bibb screw kit | | |
| PART# | Use | Size | Pcs |
| 13334 | Bibb screw | 3/8" x 8-32 | 25 |
| 13335 | Bibb screw | 1/2" x 8-32 | 25 |
| 13336 | Bibb screw | 3/8" x 10-32 | 25 |
| 13337 | Bibb screw | 1/2" x 10-32 | 25 |
| 13338 | Bibb screw | 3/8" x 10-24 | 25 |
| 13339 | Bibb screw | 1/2" x 10-24 | 25 |

SECTION "E" TUB & SHOWER INDEX

| | | | |
|----------------------------------|------|-------------------------------|------|
| ABS Shower Drains | E-21 | Shower - Rod D Style | E-18 |
| Add A Shower - Bathcock | E-20 | Shower - Rod Rectangular | E-18 |
| Add A Shower - Faucets | E-20 | Shower Arm "L" | E-4 |
| Add A Shower - Parts | E-19 | Shower Arm Elbow | E-7 |
| Add A Shower - Rods | E-19 | Shower Arm Flange | E-5 |
| Arm & Flange Shower Packs | E-6 | Shower Arm Test Nipple | E-5 |
| Bars - Grab | E-25 | Shower Curtin Hook Up Kits | E-15 |
| Bars - Towel | E-27 | Shower Diverter Valves | E-8 |
| Bathcock - for Add A Shower | E-20 | Shower Drain -Brass | E-21 |
| Bathcock Elbow | E-7 | Shower Drain - Offset ABS | E-22 |
| Bathtub Grab Bars | E-25 | Shower Drains | E-21 |
| Bathtub Splash Guard | E-13 | Shower Drains, for Pan Liner | E-21 |
| Bushings - Tub Spout | E-12 | Shower Escutcheons | E-16 |
| Clawfoot Bath Overflow Strainer | E-23 | Shower Head - Economy | E-3 |
| Clawfoot Bath Tub Supplies | E-7 | Shower Head - Sunflower | E-3 |
| Cover Up Plates - Shower | E-14 | Shower Head Niagara | E-3 |
| Curtin Rings | E-15 | Shower Heads | E-1 |
| Curved Shower Rod - Hardware | E-14 | Shower Pan Liner | E-24 |
| Curved Shower Rods | E-14 | Shower Pan Liner Cement | E-24 |
| DELTA - Shower Escutcheons | E-16 | Shower Rod - Tension | E-13 |
| DELTA - Shower Trim Kits | E-17 | Shower Rod Flanges | E-15 |
| Diverter Valves, Shower Arm | E-8 | Shower Rods | E-13 |
| Drain - Utility | E-23 | Shower Rod - Curved | E-14 |
| Drains - ABS Solvent Weld | E-23 | Shower Trim Kits | E-17 |
| Drains - Shower | E-21 | Shower Valve Plates | E-14 |
| Elbow - Twin Brass | E-7 | Snap In Floor Strainers | E-23 |
| Elbow for Shower | E-7 | Splash Guards | E-13 |
| Escutcheons - Shower | E-16 | Spout Rings | E-12 |
| Faucets for Add A Shower Flange | E-20 | Spouts - Long | E-10 |
| Flange Shower Arm | E-5 | Spouts - Tub | E-9 |
| Flanges - Shower Rod | E-15 | Spouts - Hand Held Shower | E-9 |
| Flood Guards, Brass | E-23 | Strainers - Replacement Floor | E-23 |
| Grab Bars | E-25 | Strainers - Tub Three Prong | E-23 |
| High Rise Shower Arm | E-4 | Supply - Clawfoot Bath Tubs | E-7 |
| Hook Up Kits for Shower | E-15 | Sureflow Shower Heads | E-2 |
| Hose -Shower | E-4 | SYMMONS - Shower Escutcheons | E-16 |
| Liner -Shower Pan | E-24 | SYMMONS - Shower Trim Kits | E-17 |
| MIXET - Shower Escutcheons | E-16 | Tension Shower Rod | E-13 |
| MIXET - Shower Trim Kits | E-17 | Toilet Paper Holder | E-27 |
| MIXET - Style Tub Spouts | E-11 | Toothbrush & Glass Holder | E-27 |
| MOEN - Shower Escutcheons | E-16 | Towel Bars | E-27 |
| MOEN - Shower Trim Kits | E-17 | Towel Shelf & Rack | E-27 |
| Nipples - Tubs | E-12 | Trim Kits -Shower | E-17 |
| Overflow Strainer, Clawfoot Tubs | E-23 | Trim Packs Shower | E-6 |
| Parts for Add A Shower | E-19 | Tub - Faucet Nipples | E-12 |
| POWERS - Shower Escutcheons | E-16 | Tub Spout - Long | E-10 |
| Rings for Tub Spout | E-12 | Tub Spout - Waterfall | E-11 |
| Rod - "D" Style -Shower | E-18 | Tub Spout Bushings | E-12 |
| Rod - Corner Shower | E-18 | Tub Spout Kits | E-11 |
| Rod - Rectangular Shower | E-18 | Tub Spouts | E-9 |
| Rod - Shower | E-13 | Utility Drains | E-23 |
| Shower - Arm & Flange Packs | E-6 | Waterfall Tub Spout | E-11 |
| Shower - Rod Corner | E-18 | | |

SHOWER HEADS

E

SHOWER HEAD - PEAR STYLE



- Chrome
- 3 function: spray, pulsating and jet settings
- Pear style
- Display packaged
- cUPC approved

| PART# | DESCRIPTION |
|-------|------------------------|
| 1201 | 3 function shower head |

SHOWER HEAD - ADJUSTABLE, SOLID BRASS VANDAL RESISTANT



- Solid brass shower heads
- 2 sizes, 1-1/4" & 2-1/4"
- Vandal resistant models available
- Chrome finished
- cUPC approved

| PART# | TYPE | FACE SIZE |
|--------|------------------|-----------------|
| 2036 | Standard | 1-3/4" diameter |
| 2037 | Standard | 2-1/4" diameter |
| 2036VP | Vandal resistant | 1-3/4" diameter |
| 2037VP | Vandal resistant | 2-1/4" diameter |

SHOWER HEAD - DELUXE MESSAGE - CSA



- 1.5 GPM @ 60psi
- 3 function pulsating massage
- Fingertip control
- Display carded
- CSA approved

| PART# | DESCRIPTION |
|--------|----------------|
| 1208 | Chrome plated |
| 1208BN | Brushed nickel |

TUB & SHOWER

SHOWER HEADS

SHOWER HEAD - SUREFLOW



- 1/2" FPT
- Easily adjusts from fine to peppery spray
- Chrome plated brass ball joint
- 2.5 GPM @ 70 PSI
- Removable filter screen prevents clogging of spray
- SIMPLY THE BEST SHOWER HEAD
- CSA approved

SHOWER HEAD - SUREFLOW ALL CHROME



- 1/2" FPT
- Easily adjusts from fine to peppery spray
- Chrome plated brass ball joint
- 2.5 GPM @ 70 PSI
- Removable filter screen prevents clogging of spray
- SIMPLY THE BEST SHOWER HEAD
- CSA approved

PART# DESCRIPTION

2001 Canadian style

PART# DESCRIPTION

1167 All chrome

SHOWER HEAD LYNCAR SUREFLOW ADJUSTABLE LOW FLOW AND VANDAL RESISTANT



- SUREFLOW model
- Low flow 1.5 GPM head
- Vandal resistant model
- CSA approved

SHOWER HEAD - SPEAKMAN STYLE



- Chrome plated brass
- 6 jet adjustment
- T handle spray adjustment
- 2.5 GPM output

PART# DESCRIPTION

2002 Low flow, SUREFLOW head
2002VP Low flow, SUREFLOW head, vandal resistant

PART# DESCRIPTION

1204 Shower head - SPEAKMAN style

SHOWER HEADS

SHOWER HEAD - SUNFLOWER



- Solid brass
- 5" diameter
- 44 beads of spray
- Chrome or gold finish
- cUPC approved



| PART# | DESCRIPTION |
|-------|-------------|
|-------|-------------|

- | | |
|-------------|---------------------|
| 3210 | Chrome plated brass |
| 3211 | Gold plated brass |

SHOWER HEAD NIAGARA CONSERVATION



- 9-jet turbo massage is adjustable: gentle needle spray to forceful jet
- Consistent flow rate regardless of water pressure
- Saves 40% more water & energy then a standard 2.5 GPM showerhead
- Non-aerating spray means less temperature loss
- Self-cleaning & maintenance-free
- Corrosion-resistant, high-impact ABS thermoplastic body
- Meets or exceeds ANSI specifications
- 10-year guarantee
- CSA approved



| PART# | DESCRIPTION |
|-------|-------------|
|-------|-------------|

- | | |
|---------------|--------------------------|
| 1169CH | Chrome |
| 1169 | White |
| 1169V | White - vandal resistant |

SHOWER HEAD HAND HELD NIAGARA CONSERVATION



- Flow rate @ high PSI:1.5 GPM
- Flow rate @ low PSI:1.0 GPM
- Stream type:spray, massage & combo
- Adjustable angle:yes
- Type of control:pressure compensator
- Head length:3-5/16" (84 mm)
- Handheld length:8-11/16" (221 mm)
- Mounting type:hand held with wall mount bracket head
- Diameter:2-11/16" (68 mm)
- Nozzle quantity:9-45 (spray dependant)
- Finish:chrome



| PART# | DESCRIPTION |
|-------|-------------|
|-------|-------------|

- | | |
|---------------|-----------|
| 2945CH | Hand held |
|---------------|-----------|

SHOWER HEAD ALL DIRECTIONAL ARM



- Downpour rainshower head
- Adjustable arm 9"
- 3-1/2" diameter head
- Adjustable arm
- Several finishes available

| PART# | FINISH |
|-------|--------|
|-------|--------|

- | | |
|-------------|--------------|
| 3200 | Chrome |
| 3201 | White |
| 3202 | Satin |
| 3203 | Polish brass |

SHOWER HEAD - ECONOMY



- 1/2" FPT
- 2.75 GPM @ 70 PSI
- Adjustable
- Chrome finish
- Economy CP plastic
- Brass ball



| PART# | DESCRIPTION |
|-------|-------------|
|-------|-------------|

- | | |
|----------------|-----------------------|
| 1189CSA | Shower head - economy |
|----------------|-----------------------|

TUB AND SHOWER

SHOWER HOSE



- 1/2" x 1/2"
- Double lock hose with conical end in chrome
- Our armoured metal hoses are double locked
- Double lock makes for a much stronger, longer lasting hose
- Premium quality shower hose
- NSF approved



| PART# | LENGTH | FINISH |
|---------|--------|----------------|
| 55548 | 48" | Chrome |
| 55560 | 60" | Chrome |
| 55560BN | 60" | Brushed nickel |
| 55572 | 72" | Chrome |
| 55572BN | 72" | Brushed nickel |
| 55584 | 84" | Chrome |

SHOWER HIGH RISE ARM



- Increases height of any shower head
- Chrome plated brass
- 10" length x 1/2" IPS
- Sold less shower head

| PART# | LENGTH |
|-------|------------------------|
| 1190 | 10" - "S" arm & flange |
| 1191 | 8" - "S" arm & flange |

SHOWER - ADJUSTABLE ARM



- 1/2" MPT x 1/2" FPT
- 10" length
- Chrome plated brass
- Locking wingnuts allow
- Any height adjustment
- Shower head not included

| PART# | DESCRIPTION |
|-------|-------------------------|
| 1192 | Shower - adjustable arm |

"L" BEND SHOWER ARM 1/2 IPS 90°



- 1.6 mm brass
- Highest quality
- Flange included

| PART# | DESCRIPTION |
|----------|------------------------------|
| 1194 | 10" - "L" arm |
| 119417 | 17" - "L" arm |
| 119417BN | 17" - "L" arm brushed nickel |

TUB AND SHOWER

SHOWER ARMS



- 1.6 mm brass
- Highest quality

| PART# | FINISH | SIZE |
|----------------|----------------|------|
| 1185 | Chrome | 6" |
| 1186 | Chrome | 8" |
| 1193 | Chrome | 10" |
| 1185PB | Polished brass | 6" |
| 1186PB | Polished brass | 8" |
| 1185BN | Brushed nickel | 6" |
| 1186BN | Brushed nickel | 8" |
| 1193BN | Brushed nickel | 10" |
| 1185ORB | Oil rub bronze | 6" |
| 1186ORB | Oil rub bronze | 8" |

ROUGH IN SHOWER TEST NIPPLE



- Performs your test before shower installation
- Threads into wing back 90 degrees
- Reusable plastic
- PEX drop ear elbow (**part#69521**) not included (**see page G-1**)

| PART# | DESCRIPTION |
|-------------|--------------------|
| 4760 | Shower test nipple |

SHOWER ARM FLANGE SURE GRIP



- Slip on flanges
- For shower arms
- Several finishes available

| PART# | FINISH |
|---------------|----------------|
| 1182 | Chrome |
| 1182PB | Polished brass |
| 1182BN | Brushed nickel |

SHOWER ARM FLANGE SET SCREW



- Different finishes available
- With set screw

| PART# | FINISH |
|----------------|-------------------|
| 1187 | Chrome |
| 1187PB | Polished brass |
| 1187BN | Brushed nickel |
| 1187ORB | Oil rubbed bronze |

TUB AND SHOWER

SHOWER - ARM & FLANGE PACKS



- 1.6 mm thick 6" shower arm with SURE GRIP flange
- Shower packs with 6" brass shower arm & SURE GRIP shower flange

| PART# | FINISH | DESCRIPTION |
|--------|----------------|--------------|
| 1189 | Chrome | Arm & flange |
| 1189BN | Brushed nickel | Arm & flange |
| 11895 | Polished brass | Arm & flange |

SHOWER - HEAD, ARM & FLANGE PACKS



- Head , arm & flange packs with 6" brass shower arm, SURE GRIP shower flange & several choices of shower heads available
- Commonly known as builder kits
- CSA approved

| PART# | DESCRIPTION | HEAD |
|---------|---|---------|
| 1196CSA | With C.P. plastic CSA economy head(shown) | 1189CSA |
| 11964 | With "SUREFLOW" head | 2001 |
| 11965 | With "SUREFLOW" all chrome head | 1167 |
| 12085 | With deluxe CSA chrome head | 1208 |



SHOWER - COMPLETE TRIM PACKS, WITH ECONOMY HEAD



- All kits include: tub spout, shower arm 6", flange and shower head
- Boxed packaged kit
- Choose your spout and shower head
- CSA approved

| PART# | SHOWER HEAD | TUB SPOUT | FINISH |
|---------|----------------------------------|----------------------------|----------------|
| 1199CSA | Economy (part#1189CSA) | Slip fit (part#1142) | Chrome |
| 1198 | Economy (part#1189CSA) | Front mounting (part#1128) | Chrome |
| 1199BN | Adjustable massage (part#1208BN) | Slip fit (part#1142BN) | Brushed Nickel |

SHOWER - COMPLETE TRIM PACKS, WITH SUREFLOW HEAD



- CSA approved

| PART# | SHOWER HEAD | TUB SPOUT |
|--------|----------------------|----------------------------|
| 1199TK | SUREFLOW (part#2001) | Slip fit (part#1142) |
| 1198TK | SUREFLOW (part#2001) | Front mounting (part#1128) |
| 1167TK | SUREFLOW (part#1167) | Slip fit (part#1142) |

TUB AND SHOWER

SHOWER ARM ELBOW

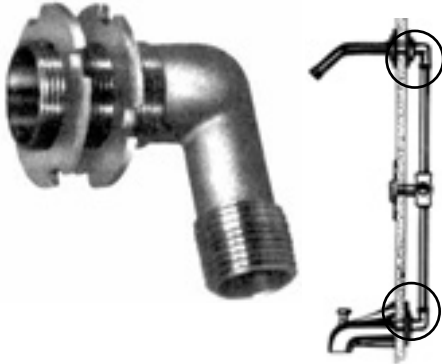

- This brass elbow securely mounts a shower arm to a fiberglass shower stall
- Can be used to secure a tub spout nipple. Can be used with copper, iron pipe or compression fittings
- Prevents movement of shower arm & tub spout
- Locknuts secure elbow to fiberglass wall
- Requires 1-1/32" hole through fiberglass
- Outlet end 1/2" FIP
- Inlet end 1/2" CWT / MPT, 1/2 PEX
- PEX end also available in 1/2" & 3/4" (see page G-8)

| PART# | DESCRIPTION |
|-------|-----------------------|
| 1195 | 1/2" CWT / MPT |
| 1195Q | 1/2" CWT / MPT - bulk |

BATHCOCK ELBOW



- 1/2" MPT
- Satin finish brass
- Sold by the pair

| PART# | DESCRIPTION |
|-------|----------------|
| 1793 | Bathcock Elbow |

SUPPLY - CLAWFOOT BATH TUBS



- 2 styles with nuts & washers
- 1/2" chrome plated copper
- Sold per pair in boxes

| PART# | DESCRIPTION |
|-------|--------------------------------------|
| 1792 | 90° single bend For 3-3/8" centers |
| 17925 | Offset bend for 3-3/8" to 4" centers |

ROUGH BRASS TWIN ELBOW



- Double quarter turn brass elbow
- 3/4" x 1/2" x 1/2"
- Use on diverter spout 3/4" to 1/2" shower

| PART# | DESCRIPTION |
|-------|------------------------|
| 1145 | Rough brass twin elbow |

TUB AND SHOWER

PUSH CONTROL SHOWER DIVERTER VALVE



- Push-down, pull-up diverter valve changes the direction of water flow
- Very high quality construction & finish
- Standard 1/2" thread size
- Material: solid brass, all metal construction

SHOWER ARM SHUT OFF



- 1/2" MPT x 1/2" FPT
- Chrome plated brass
- Shower head will still dribble after shut off to prevent back flow

| PART# | DESCRIPTION |
|-------|--|
| 1166B | Push control shower diverter valve chrome plated brass |

| PART# | DESCRIPTION |
|-------|---------------------|
| 1168 | Shower arm shut off |

SHOWER ARM DIVERTER



- Two 1/2" MPT with one 1/2" FPT
- Chrome plated ABS plastic
- Allows connection of hand held shower

SHOWER ARM / HOSE COMBO DIVERTER



- Two 1/2" MPT with one 1/2" FPT
- Chrome plated brass body, ABS handle
- Allows connection of hand held shower

| PART# | DESCRIPTION |
|-------|--------------------------|
| 1166 | Shower arm diverter, ABS |

| PART# | DESCRIPTION |
|-------|----------------------------|
| 2267 | Shower arm & hose diverter |

TUB SPOUTS

TUB SPOUT



- Chrome plated brass or die cast
- 5-5/8" length
- CSA approved



| PART# | MATERIAL | FINISH | MOUNT | FPT | APPROVAL |
|---------------|----------|------------|-------|-------------|----------|
| 1115 | Brass | Chrome | Front | 1/2" | - |
| 1126 | Brass | Chrome | Back | 1/2" - 3/4" | - |
| 1134 | Die cast | Chrome | Front | 1/2" | CSA |
| 1134PB | Die cast | Pol. brass | Front | 1/2" | CSA |

TUB SPOUT WITH DIVERTER



- Thread in front
- Chrome plated brass or die cast
- 5-5/8" length front mount
- Front mount diverter
- CSA approved



| PART# | MATERIAL | FINISH | FPT | APPROVAL |
|---------------|----------|------------|------|----------|
| 1117 | Brass | Chrome | 1/2" | - |
| 1128 | Die cast | Chrome | 1/2" | CSA |
| 1128PB | Die cast | Pol. brass | 1/2" | - |

TUB SPOUT - ADJUSTABLE



- Chrome plated die cast 5-5/8" Length
- With or without diverter (front)
- Several finishes available
- CSA approved



| PART# | FINISH | ADJUST | DIVERTER | PIPE SIZE |
|---------------|----------------|--------|----------|-----------------|
| 1136 | Chrome | 2-1/4" | No | "SLIP FIT" |
| 1136BN | Brushed nickel | 2-1/4" | No | "SLIP FIT" |
| 1142 | Chrome | 2-1/4" | Yes | "SLIP FIT" |
| 1142BN | Brushed nickel | 2-1/4" | Yes | "SLIP FIT" |
| 1142PB | Polished brass | 2-1/4" | Yes | "SLIP FIT" |
| 1143 | Chrome | 1" | No | 1/2" - 3/4" FPT |
| 1144 | Chrome | 1" | Yes | 1/2" - 3/4" FPT |

HAND HELD SHOWER SPOUT WITH DIVERTER



- Chrome plated die cast spouts
- With diverter, back
- With top or side adapter for shower hose
- 1/2" male hose adapter
- 1/2"-3/4" IPS back mount
- Protrusion from wall: 5-1/8"
- FPT: 1/2" or 3/4"

| PART# | SHOWER OUTLET |
|--------------|---------------|
| 1133 | Top |
| 1133S | Side |

TUB SPOUTS

WALTEC STYLE TUB SPOUT



- Chrome plated die cast - 5-5/8" length
- With plastic insert to accept WALTEC tub nipple
- CSA approved

| PART# | FINISH | DIVERTER |
|-------|--------|----------|
| 1135 | Chrome | Yes |
| 1132 | Chrome | No |

SPOUT - DIVERTER, BACK LIFT



- Chrome plated brass or die cast
- 5-5/8" length back mount
- CSA approved

| PART# | MATERIAL | FTP | APPROVAL |
|-------|----------|-----------|----------|
| 1127 | Brass | 1/2" | - |
| 1129 | Brass | 3/4" | - |
| 1137 | Die cast | 1/2" | CSA |
| 1138 | Die cast | 3/4" | CSA |
| 1140 | Die cast | 1/2"-3/4" | CSA |

TUB SPOUT - 7" LONG



- Chrome or brushed nickel
- 7" spout, plated die cast, with or without diverter
- CSA approved

| PART# | DIVERTER | FINISH | PIPE SIZE | STYLE |
|---------|----------|----------------|-----------|-------|
| 11287 | Yes | Chrome | 1/2" IPS | Front |
| 11347 | No | Chrome | 1/2" IPS | Front |
| 11367 | No | Chrome | 1/2" CWT | Slip |
| 11367BN | No | Brushed nickel | 1/2" CWT | Slip |
| 11427 | Yes | Chrome | 1/2" CWT | Slip |
| 11427BN | Yes | Brushed nickel | 1/2" CWT | Slip |

TUB SPOUT - 9" LONG, SOLID BRASS



- 9" spout, chrome plated brass
- Front style

| PART# | DIVERTER | PIPE SIZE |
|-------|----------|-----------|
| 1115E | No | 1/2" IPS |
| 1117E | Yes | 1/2" IPS |

TUB SPOUTS

DIY UNIVERSAL TUB SPOUT KITS



- Blister pack includes adapters, allen wrench & teflon tape
- Fits all existing plumbing: 3/4" thread, 1/2" thread, 1/2" copper slip fit, 1/2" thread in nose
- CSA approved



| PART# | DESCRIPTION |
|-------|-------------|
|-------|-------------|

- | | |
|------|---------------|
| 1113 | No diverter |
| 1114 | With diverter |

MIXET STYLE SPOUTS



- Front spring diverter, for positive action shut
- CSA approved
- Slip on tub spout; with set screw
- Chrome plated finish
- CSA approved



| PART# | DESCRIPTION |
|-------|-------------|
|-------|-------------|

- | | |
|-------|-------------------|
| 1400 | 5-1/8" long model |
| 14001 | 7" long model |

DELUXE STYLE TUB SPOUTS



- Deluxe style 6" tub spout
- With diverter at front
- Front thread or slip fit models
- CSA approved



| PART# | DESCRIPTION |
|-------|-------------|
|-------|-------------|

- | | |
|---------|---------------------------------------|
| 1403 | Front mounting connection |
| 1404 | Slip fit connection chrome |
| 1404BN | Slip fit connection brushed nickel |
| 1404ORB | Slip fit connection oil rubbed bronze |

WATERFALL SPOUT



- Decorative waterfall spout with or without diverter
- CSA approved
- Fits all existing plumbing: 3/4" thread, 1/2" thread, 1/2" copper slip fit, 1/2" thread in nose
- 6" overall length
- 3-7/8" wide at the back and 3" wide at the front
- Chrome and brushed nickel available
- CSA approved



| PART# | DESCRIPTION |
|-------|-------------|
|-------|-------------|

- | | |
|---------|------------------------------|
| 11387 | Chrome with diverter |
| 11387BN | Brushed nickel with diverter |
| 11389 | Chrome less diverter |
| 11389BN | Brushed nickel less diverter |

TUB AND SHOWER

SPOUT RINGS



- LYNCAR spout rings take a standard LYNCAR tub spout (and most of our competitors models) & turns it into a decorative tub spout
- Two uses: for your customer its a decorative tub spout, for you, you have fixed the "gap" between the spout & the wall

| PART# | DESCRIPTION |
|--------|----------------|
| 1116 | Chrome |
| 1116BN | Brushed nickel |

DIVERTER LIFT REPLACEMENT



- Fits spouts:
part#1128, part#11287, part#11427, part#1142 & part#1144
- Brass lift
- Rubber washer
- Plastic slide
- Installs in seconds

| PART# | DESCRIPTION |
|-------|---------------------------|
| 1109 | Diverter lift replacement |

TUB SPOUT BUSHINGS



| PART# | MATERIAL | SIZE |
|-------|----------|---------------------|
| 1139 | Plastic | 3/4" IPS x 1/2" IPS |
| 1141 | Brass | 3/4" IPS x 1/2" IPS |
| 1146 | Brass | 1/2" IPS x 3/8" IPS |

TUB - FAUCET NIPPLES



| PART# | DESCRIPTION | MATERIAL |
|-------|---|----------|
| 1110 | 1/2" x 3-1/4" use for EMCO (OEM ref#51-194387) | Brass |
| 1111 | 1/2" x 4-1/2" all purpose | Brass |
| 1112 | 1/2" x 7" use for BELANGER | Brass |
| 11315 | Multi use plastic 3 1/4" long, includes threads 3/8" for PRICE PFISTER, 5/8" x 18 TPI & 5/8" x 24 TPI - CRANE, KOHLER, STERLING 9/16" x 20 TPI for AM-STD, ELJER | Plastic |

TUB AND SHOWER

TENSION SHOWER ROD

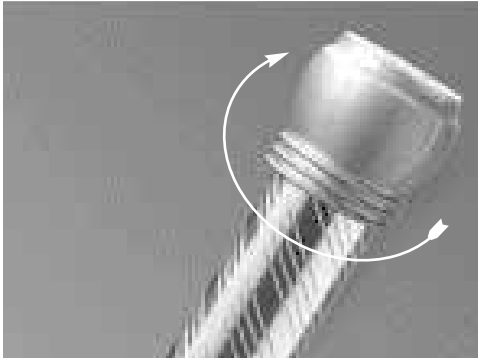

- Twist to expand tension shower rod
- Adjustable 36" - 63"
- 6 per carton
- Individually wrapped & bar coded

| PART# | DESCRIPTION |
|-------------|-------------|
| 1291 | White |
| 1292 | Chrome |
| 1293 | Brass |

SHOWER ROD - STRAIGHT



- 1" O.D. aluminum rod
- Polished aluminum shower rod with 5ft or 6ft lengths
- Packed 12 per box for your convenience
- Flange and hooks not included (see page E-15)

| PART# | DESCRIPTION |
|-------------|--------------|
| 1260 | 5ft long rod |
| 1261 | 6ft long rod |

BRASS SHOWER ROD, SPECIAL FINISHES



- Premium shower rods
- Brass pipe 1" diameter
- Plated & brushed
- Packed with flanges 1 set per box

| PART# | DESCRIPTION |
|--------------|-----------------------|
| 12608 | Brushed nickel plated |
| 12609 | Oil rubbed bronze |

BATHTUB SPLASH GUARDS



- White plastic
- 2 sizes available
- Packaged for display, sold by the pair

| PART# | DESCRIPTION |
|--------------|-------------|
| 15214 | 7" x 7" |
| 15215 | 7" x 9" |

TUB AND SHOWER

CURVED SHOWER ROD



- Very popular curved shower rod from LYNCAR is available in a retail box or as bulk contractor packs
- Increase the shower space in your bathtub
- Fits all standard tubs

| PART# | DESCRIPTION | BOX PACK |
|----------------|---|----------|
| 1280 | 5 ft chrome steel with hardware | 1 |
| 1280Q | 5 ft chrome steel 12 unit contractor pack | 12 |
| 1280BN | 5 ft brushed nickel with hardware | 1 |
| 1280BNQ | 5 ft brushed nickel 12 unit contractor pack | 12 |
| 1281 | 6 ft chrome steel with hardware | 1 |
| 1281Q | 6 ft chrome steel 12 unit contractor pack | 12 |

RETROFIT PLATE FOR
CURVED SHOWER
ROD

- **Part#1280HK** is included with 1 pack of the curved rod (shown above)
- Existing holes from previous shower rod installation are covered
- No additional fasteners are required

| PART# | DESCRIPTION |
|---------------|-----------------------------|
| 1280HK | 4-3/4" wide x 3-1/2" height |

CURVED SHOWER ROD - 3 PIECE



- Compact design for reduced shelf space
- Three sections 1" rod
- Fits standard 5ft tubs
- Chrome finish
- Box packaged

| PART# | DESCRIPTION |
|-------------|--------------------------------|
| 1299 | Curved shower rod 3 piece unit |









QUICK VALVE PLATE



- Old ceramic tile is impossible to match
- The Quick Valve Plate covers the unsightly hole left in the tile after the shower valve is replaced
- Stainless steel
- **Part#815** fits MOEN & DELTA & is our #1 seller
- Screws & brackets provided
- Polished stainless steel not affected by household cleaners 13" long x 7-1/4" wide

| PART# | DESCRIPTION | HOLES | HOLE SIZE OR CENTRES |
|--------------|----------------|-------|----------------------|
| 815 | Stainless | 1 | 5" |
| 815PB | Polished brass | 1 | 5" |
| 815BN | Brushed nickel | 1 | 5" |
| 816 | Stainless | 2 | 5" |
| 817 | Stainless | 3 | 8" centres |
| 818 | Stainless | 1 | 3-1/2" |
| 819 | Stainless | 1 | 4-1/2" |
| 820 | Stainless | 0 | No holes |

TUB AND SHOWER

| PRESS FIT | | FLANGE | |
|---|--|--|---|
|  | <ul style="list-style-type: none"> - Die cast metal or plastic - Press fit - Chrome or brushed nickel |  | <ul style="list-style-type: none"> - Oblong shower flange - Chrome plastic - With screws - 4-1/2" x 1-5/8" |
| PART# | DESCRIPTION | PART# | DESCRIPTION |
| 1252 | Die cast, chrome | 1255 | Oblong flange |
| 1252BN | Die cast, brushed nickel | 1255Q | Oblong flange - bulk |
| 1253 | Plastic, chrome plated | | |
| SHOWER FLANGE ROUND | | JUMBO STEEL | |
|  | <ul style="list-style-type: none"> - Round chrome shower flanges - Stamped steel - 1-3/8" diameter - Shower rod has extra hold with set screw |  | <ul style="list-style-type: none"> - Oversized shower flange - Die cast steel - Shower rod has extra hold with set screw - 5-1/8" x 1-5/8" |
| PART# | DESCRIPTION | PART# | DESCRIPTION |
| 1254 | Shower rod metal | 1257 | Jumbo CP die cast |
| 1254Q | Shower rod metal - bulk | 1257Q | Jumbo CP die cast - bulk |
| 1254BN | Shower rod metal brushed nickel | | |
| 1254BNQ | Shower rod metal brushed nickel - bulk | | |
| CURTAIN RINGS W/ BRASS ROLLERS | | CURTAIN RINGS | |
|  | <ul style="list-style-type: none"> - Solid brass - Shower curtain rings - Rust resistant roller balls make sliding shower curtains easy - 12 rings per package |  | <ul style="list-style-type: none"> - Aluminum rings for shower curtain - Style #3 - 12 rings per package |
| PART# | DESCRIPTION | PART# | DESCRIPTION |
| 1184 | C.P. brass rollers | 1188 | Plain #3 ring |
| SHOWER HOOK UP KIT WITH OBLONG FLANGE | | SHOWER HOOK UP KIT WITH PRESS FIT FLANGE | |
|  | <ul style="list-style-type: none"> - Complete shower curtain and rod hook up kit - Chain, hook, rings and flange - With part#1255 oblong flange |  | <ul style="list-style-type: none"> - Complete shower curtain and rod hook up kit - Chain, hook, rings and flange - With part#1253 CP plastic fit flange |
| PART# | DESCRIPTION | PART# | DESCRIPTION |
| 1183 | Complete with oblong flange | 1181 | Complete with press fit flange |

TUB AND SHOWER ESCUTCHEONS

SHOWER ESCUTCHEONS - MOEN



- Replacement shower valve
- Escutcheons to fit MOEN
- Flat or recessed styles
- Replacement tube is **part#11290**

| PART# | DESCRIPTION |
|--------------|---|
| 11280 | Escutcheon for MOEN 7" flat, chrome |
| 11285 | Escutcheon for MOEN 7" recessed, chrome |
| 11290 | Tube flange for MOEN escutcheon |

SHOWER ESCUTCHEONS - DELTA

part# 11240



part# 11245



- Replacement shower valve
- Escutcheons to fit DELTA
- 6-3/4" round OEM ref#RP5883
- Rectangular for SCALDGUARD OEM ref#RP6205

| PART# | DESCRIPTION |
|--------------|------------------------------------|
| 11240 | Escutcheon for DELTA 6-3/4" chrome |
| 11245 | Escutcheon for DELTA scaldguard |

SHOWER ESCUTCHEON - MIXET



- Shower escutcheon for MIXET
- 5-1/2" diameter chrome plastic
- OEM ref#MTR-5CLR

| PART# | DESCRIPTION |
|--------------|----------------------------------|
| 11281 | Escutcheon 5-1/2" chrome plastic |

SHOWER ESCUTCHEON - POWERS CRANE



- Shower escutcheon for POWERS CRANE
- Fits 800/900 models

| PART# | DESCRIPTION |
|--------------|---------------------------|
| 11283 | Round 6-1/2" shower plate |

SHOWER ESCUTCHEONS - SYMMONS



- SYMMONS shower escutcheons
- Available with plate A, B or C
- Model A = diverter control OEM ref#T29
- Model B = shower only OEM ref#T29B
- Model C = volume control OEM ref#T29C

| PART# | DESCRIPTION |
|--------------|----------------------|
| 11336 | With model "A" plate |
| 11332 | With model "B" plate |
| 11329 | With model "C" plate |

OEM (Original Equipment Manufacturer) numbers, registered / non registered trademarks, faucet name, and manufacturer listed above are supplied and listed for your reference only. All LynCar items are precision made and tested to the highest standards, by qualified factories inspected and approved by LynCar.

SHOWER TRIM KITS

DELTA SHOWER TRIM KITS



- Replacement trim kit for DELTA shower valves
- Available in chrome or brushed nickel
- Blister packaged
- Two handle options, round acrylic, or die cast lever
- Kit replaces DELTA 600 series (#70 or #212 ball) and DELTA MONITOR 14 series.
- Includes faceplate, 2 handles, screws, adapters and Allen wrench

| PART# | DESCRIPTION |
|-------|-------------|
|-------|-------------|

- | | |
|----------------|----------------|
| 11368 | Chrome |
| 11368BN | Brushed nickel |

MIXET SHOWER TRIM KITS



- MIXET shower escutcheons
- 5-1/2" shower escutcheon, chrome
- Inner handle metal or plastic
- OEM ref#MTR4

| PART# | DESCRIPTION |
|-------|-------------|
|-------|-------------|

- | | |
|--------------|--|
| 11362 | MIXET trim kit with clear plastic inner handle |
| 11363 | MIXET trim kit with chrome inner handle |

MOEN SHOWER TRIM KITS



- Replacement trim kit for DELTA shower valves
- Available in chrome or brushed nickel
- Blister packaged
- Two handle options, round acrylic, or die cast Lever
- Kit replaces MOEN legend mentrol 2200, 2400, 2600 and 2700 series
- MOEN POSI TEMP(R) series and CHATEAU models
- Includes faceplate, 2 handles, screws, adapters and Allen wrench

| PART# | DESCRIPTION |
|-------|-------------|
|-------|-------------|

- | | |
|----------------|----------------|
| 11369 | Chrome |
| 11369BN | Brushed nickel |

SYMMONS SHOWER TRIM KITS



- SYMMONS trim kits
- Includes handle, lever, faceplate, escutcheon, dome, and hardware
- Less shower head/arm
- OEM ref#S-96 series

| PART# | DESCRIPTION |
|-------|-------------|
|-------|-------------|

- | | |
|--------------|------------------------------------|
| 11364 | Model A with handle / lever / dome |
| 11365 | Model B with handle / lever / dome |
| 11366 | Model C with handle & dome |

SHOWER RODS

SHOWER - ROD CORNER



- 1" diameter
- Jumbo flanges & 36" ceiling support
- Individually boxed

| PART# | ROD LENGTH | DESCRIPTION |
|-------------|------------|---------------------|
| 1262 | 60" x 27" | Polished aluminum |
| 1263 | 72" x 27" | Polished aluminum |
| 1284 | 60" x 27" | Chrome plated brass |
| 1285 | 72" x 27" | Chrome plated brass |

SHOWER - ROD D STYLE



- 1" diameter
- Round flanges & 36" ceiling support
- Individually boxed

| PART# | ROD LENGTH | DESCRIPTION |
|-------------|------------|---------------------|
| 1264 | 54" x 27" | Polished aluminum |
| 1265 | 60" x 27" | Polished aluminum |
| 1286 | 54" x 27" | Chrome plated brass |
| 1287 | 60" x 27" | Chrome plated brass |

SHOWER - ROD RECTANGULAR



- 1" diameter
- 1-36" ceiling support
- 1-10" wall support
- Round flanges
- Individually boxed

| PART# | LENGTH X WIDTH | DESCRIPTION |
|-------------|----------------|---------------------|
| 1271 | 48" x 27" | Polished aluminum |
| 1272 | 54" x 27" | Polished aluminum |
| 1288 | 48" x 27" | Chrome plated brass |
| 1289 | 54" x 27" | Chrome plated brass |

SHOWER ROD CEILING SUPPORT

36" FIT-ALL CEILING SUPPORT COMPLETE

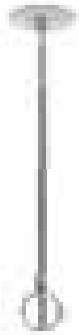

| PART# | DESCRIPTION |
|-------|--------------------------------------|
| 1259 | 36" FIT-ALL ceiling support complete |

HINGED CEILING SUPPORT FOR ANGLED CEILINGS



| PART# | DESCRIPTION |
|-------|--|
| 1245 | Hinged ceiling support for angled ceilings |

1" LOOP



| PART# | DESCRIPTION |
|-------|--------------|
| 1267 | 1" loop ONLY |

ROD HOLDER, ANGLE



- Fits 1" shower rod

| PART# | DESCRIPTION |
|-------|---------------------------|
| 1248 | Angled ceiling rod holder |

ADD-A-SHOWER RISER BRACKETS

part#1246

Fits 1" Shower Rod

part#1247

Fits 3/8" Riser

Fits 3/8" Riser

part#1258

Fits 1" Shower Rod

part#1269

Fits 3/8" Riser

| PART# | DESCRIPTION |
|-------|--|
| 1246 | Fixed wall brackets for risers |
| 1247 | Bracket for risers |
| 1258 | Rod to riser coupling |
| 1269 | Rod coupling loop for part#1264 & part#1265 |

ADD - A - SHOWER

ADD - A - SHOWER OVER THE RIM



- Chrome plated die cast spout 1/2" IPS

| PART# | DESCRIPTION |
|-------|--------------------------------|
| 2825 | Over the rim supplied as shown |
| 2831 | Spout ONLY |

ADD - A - SHOWER REGULAR STYLE



- Chrome plated brass bathcock
- Specifically for CLAWFOOT

| PART# | DESCRIPTION |
|-------------------|---|
| 2826 | Regular style bathcock 3-3/8" centers supplied as shown |
| 2832 | Bathcock ONLY |
| Replacement parts | |
| 1247 | Wall bracket with rod |
| 2836-3 | 3/8" x 60" CP brass riser |
| 1189CSA | Shower head |
| 1258 | Rod-to-riser adapter |
| 2837C | Cold stem |
| 2837H | Hot stem |
| 2838 | Bathcock seats (pair) |
| 2839 | Hot & cold handle set |









BATHCOCK (ONLY)



- Supplied with adapter (**part#2830**) to connect shower hose
- Lever handles
- 3/4" male connections
- Chrome plated brass - 3-3/8" centers
- 3/8" riser connection
- cUPC approved

| PART# | DESCRIPTION |
|-------|--------------------------------------|
| 2832 | Bathcock (only) for Add - A - Shower |
| 2830 | Adapter only for shower hose |

BRASS & ABS SHOWER DRAINS

| <p>BRASS SHOWER DRAIN QUICK SET</p>   <ul style="list-style-type: none"> - Use with Gelcoat & Acrylic shower stalls - Internal locknut & gasket for 2" DWV - Chrome plated brass strainer - Brass body & locknut - cUPC approved | <p>ABS QUICK CAULK SHOWER</p>  <ul style="list-style-type: none"> - Use with Gelcoat & Acrylic shower stalls - Internal locknut & gasket for 2" DWV - Chrome plated strainer - ABS body & locknut - cUPC approved | | | | | | | | |
|--|--|-------------|------|---------------------------------|--|-------|-------------|--------|---------------------------------|
| <table border="1"> <thead> <tr> <th>PART#</th> <th>DESCRIPTION</th> </tr> </thead> <tbody> <tr> <td>7980</td> <td>Brass shower drain quick set 2"</td> </tr> </tbody> </table> | PART# | DESCRIPTION | 7980 | Brass shower drain quick set 2" | <table border="1"> <thead> <tr> <th>PART#</th> <th>DESCRIPTION</th> </tr> </thead> <tbody> <tr> <td>8018</td> <td>ABS quick caulk shower drain 2"</td> </tr> </tbody> </table> | PART# | DESCRIPTION | 8018 | ABS quick caulk shower drain 2" |
| PART# | DESCRIPTION | | | | | | | | |
| 7980 | Brass shower drain quick set 2" | | | | | | | | |
| PART# | DESCRIPTION | | | | | | | | |
| 8018 | ABS quick caulk shower drain 2" | | | | | | | | |
| <p>2" PULL TIGHT SHOWER DRAIN COMPRESSION ABS</p>  <ul style="list-style-type: none"> - Unique pull tight design allows installation to be done from the top - Fits most 2" pipe installations - Being able to install with one person and tighten from inside shower stall saves time and money spent on labour | <p>CLAMPING STYLE ABS SHOWER DRAIN</p>   <ul style="list-style-type: none"> - Comparable to "BABY BLUE" - Stainless steel grid - Fits 2" or 1-1/2" drains - cUPC approved | | | | | | | | |
| <table border="1"> <thead> <tr> <th>PART#</th> <th>DESCRIPTION</th> </tr> </thead> <tbody> <tr> <td>8033</td> <td>2" pull tight shower drain</td> </tr> </tbody> </table> | PART# | DESCRIPTION | 8033 | 2" pull tight shower drain | <table border="1"> <thead> <tr> <th>PART#</th> <th>DESCRIPTION</th> </tr> </thead> <tbody> <tr> <td>8014</td> <td>Clamping style ABS shower drain</td> </tr> </tbody> </table> | PART# | DESCRIPTION | 8014 | Clamping style ABS shower drain |
| PART# | DESCRIPTION | | | | | | | | |
| 8033 | 2" pull tight shower drain | | | | | | | | |
| PART# | DESCRIPTION | | | | | | | | |
| 8014 | Clamping style ABS shower drain | | | | | | | | |
| <p>CLAMPING STYLE ABS SHOWER DRAIN SQUARE</p>   <ul style="list-style-type: none"> - Comparable to "BABY BLUE" - Stainless steel grid - Fits 2" or 1-1/2" drains - cUPC approved | <p>SQUARE GRID FOR CLAMPING STYLE SHOWER DRAIN BRUSHED NICKEL</p>  <ul style="list-style-type: none"> - Square top cover shower drain in brushed nickel - Fits part#8013 or part#8014 | | | | | | | | |
| <table border="1"> <thead> <tr> <th>PART#</th> <th>DESCRIPTION</th> </tr> </thead> <tbody> <tr> <td>8013</td> <td>Clamping style ABS shower drain</td> </tr> </tbody> </table> | PART# | DESCRIPTION | 8013 | Clamping style ABS shower drain | <table border="1"> <thead> <tr> <th>PART#</th> <th>DESCRIPTION</th> </tr> </thead> <tbody> <tr> <td>8015BN</td> <td>Square grid brushed nickel</td> </tr> </tbody> </table> | PART# | DESCRIPTION | 8015BN | Square grid brushed nickel |
| PART# | DESCRIPTION | | | | | | | | |
| 8013 | Clamping style ABS shower drain | | | | | | | | |
| PART# | DESCRIPTION | | | | | | | | |
| 8015BN | Square grid brushed nickel | | | | | | | | |

TUB AND SHOWER

ABS OFFSET SOLVENT WELD DRAIN



- Use with Gelcoat & Acrylic shower stalls
- Internal locknut & gasket for 2" DWV
- Chrome plated strainer
- ABS body

ABS 2 PIECE SOLVENT WELD DRAIN



- Use with Gelcoat & Acrylic shower stalls
- Chrome plated strainer
- ABS body
- cUPC approved

| PART# | DESCRIPTION |
|-------|-------------------------------|
| 8032 | ABS offset solvent weld drain |

| PART# | DESCRIPTION |
|-------|-------------------|
| 8017 | ABS 2 piece drain |

ABS 2 PIECE SOLVENT WELD DRAIN



- Use with Gelcoat & Acrylic shower stalls
- White strainer
- ABS body
- cUPC approved

CLAMPING STYLE ABS SHOWER



- Wide body flange
- Fits 2" drains
- Stainless steel grid
- cUPC approved

| PART# | DESCRIPTION |
|-------|-------------------|
| 8019 | ABS 2 piece drain |

| PART# | DESCRIPTION |
|-------|---------------------------|
| 8031 | Clamping style ABS shower |

TUB AND SHOWER

E

FLOOD GUARDS, BRASS



- LYNCAR brass flood guards.
- Available in either 3" or 4" sizes, brass body, rubber outer
- Boxed packaged

DRAIN - UTILITY



- Brass utility drain
- 2" size

| PART# | DESCRIPTION |
|-------|-------------|
| 11400 | 3" |
| 11405 | 4" |

| PART# | IPS | MATERIAL |
|-------|-----|----------|
| 1171 | 2" | Brass |

STRAINER - REPLACEMENT



- Snap-in stainless steel

ABS SOLVENT WELD DRAINS



- Solvent weld drains
- Stainless steel or one piece PVC grid
- Fits inside pipe
- Use to cover any open-end-pipe

| PART# | STRAINER SIZE | FITS |
|-------|---------------|--------|
| 1205 | 3" | 2" DWV |
| 1206 | 4" | 3" DWV |
| 1207 | 5" | 4" DWV |

| PART# | TYPE | FITS |
|-------|-----------------------|--------|
| 8020 | ABS grids | 2" DWV |
| 8021 | ABS grids | 3" DWV |
| 8022 | Stainless steel grids | 3" DWV |
| 8023 | Stainless steel grids | 4" DWV |

OVERFLOW STRAINER



- For claw foot or roll rim tubs
- 3" diameter

STRAINER - TUB THREE PRONG



- Stainless steel

| PART# | DESCRIPTION |
|-------|----------------------------|
| 1357 | Overflow strainer CP brass |

| PART# | DESCRIPTION |
|-------|-------------|
| 1342 | 1-7/8" |
| 1343 | 1-5/8" |

TUB & SHOWER

SHOWER PAN LINER

SHOWER PAN LINER



- ASTM approved D4551
- PVC shower pan liner by LYNCAR
- LYNCAR is a leader in shower pan development
- Shower pan liner has been available since 1964 as a waterproofing alternative to the expensive hot mop, or lead sheet lining methods
- LYNCAR'S shower pan is used in shower stalls, gang showers, steam rooms, roman tubs, fountains, ornamental or reflecting pools, & other concealed waterproofing applications
- LYNCAR'S shower pan liner meets ASTM specifications, & is manufactured from 100% virgin poly vinyl chloride resin
- NO regrind or recycled materials are used in manufacturing this product
- Our shower pan liner is unaffected by concrete or cement, however should not be installed where it is exposed to direct sunlight
- LYNCAR'S shower pan liner is clearly marked with our LYNCAR part number, sheet size & the product is ruled every 6" for ease of measurement
- A full & detailed "How to install shower pan liners" is available at www.lyncar.com
- cUPC approved



| PART# | WIDTH | LENGTH | COLOUR | MIL | SQ/FT PER ROLL |
|-------|-------|--------|--------|-----|----------------|
| 3015 | 4 ft | 50 ft | Black | 30 | 200 |
| 3017 | 5 ft | 40 ft | Black | 30 | 200 |
| 3019 | 6 ft | 50 ft | Black | 30 | 300 |

| PART# | DESCRIPTION |
|-------|--------------------------------|
| 3008 | Shower Pan Cement 16 oz BT/can |

LYNCAR TRUEGRIP STAINLESS STEEL GRAB BARS

E

GRAB BAR - STRAIGHT



- Professional quality
- 1-1/4" & 1-1/2" diameters
- Welded construction
- Concealed flange
- Polished stainless steel
- Knurled
- Boxed package

| PART# | TYPE | LENGTH |
|----------------|-----------------|--------|
| 5571412 | 1-1/4" diameter | 12" |
| 5571418 | 1-1/4" diameter | 18" |
| 5571424 | 1-1/4" diameter | 24" |
| 5571436 | 1-1/4" diameter | 36" |
| 5571212 | 1-1/2" diameter | 12" |
| 5571218 | 1-1/2" diameter | 18" |
| 5571224 | 1-1/2" diameter | 24" |
| 5571236 | 1-1/2" diameter | 36" |

GRAB BAR - "L" SHAPED



- 1-1/4" diameter grab bar
- Chrome plated finish
- 24" x 24" size
- Knurled
- 1 per box

| PART# | TYPE | DESCRIPTION |
|---------------|-----------------|-----------------------|
| 557321 | 1-1/4" diameter | 24 x 24" left chrome |
| 557322 | 1-1/4" diameter | 24 x 24" right chrome |

GRAB BAR - 90°



- Left or right mounting
- Professional quality
- Welded construction
- Concealed flange
- Polished stainless steel
- Knurled
- Boxed package

| PART# | TYPE | DESCRIPTION |
|---------------|-----------------|---------------------|
| 557230 | 1-1/4" diameter | 16 x 24" left hand |
| 557231 | 1-1/4" diameter | 16 x 24" right hand |

TUB & SHOWER

TUB AND SHOWER

GRAB BAR 45°



- Left or right mounting
- Professional quality
- Welded construction
- Concealed flange
- Polished stainless steel
- Knurled
- Boxed package

| PART# | TYPE | DESCRIPTION |
|--------|-----------------|---------------------|
| 557232 | 1-1/4" diameter | 33 x 27" left hand |
| 557233 | 1-1/4" diameter | 33 x 27" right hand |

BATHTUB ANGLED GRAB BAR 45°



- Small angled grab bar
- Professional quality
- Welded construction
- 2 concealed flanges of 1" diameter 45°
- Knurled

| PART# | DESCRIPTION |
|--------|-----------------------|
| 557218 | 9" x 9" x 1" diameter |

BATHTUB ANGLED GRAB BAR 80°



- Small angled grab bar
- Professional quality
- Welded construction
- 2 concealed flanges 1" diameter 80°
- Knurled

| PART# | DESCRIPTION |
|--------|---------------------------|
| 557418 | 9" x 9" x 1-1/4" diameter |

TUB AND SHOWER

TOWEL SHELF & RACK

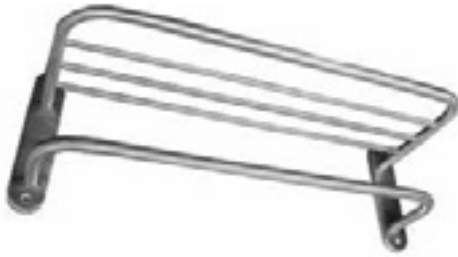

- Commercial towel bar and top shelf
- 24" wide x 10" deep, with mounting hardware
- Chrome or brushed nickel finishes

TOWEL BARS



- LYNCAR'S towel bars & accessories offer a low cost series of products for the rental, maintenance & home owner
- You can stock the complete towel bar or its components depending on your needs
- All of LYNCAR'S towel bars are chrome plated zinc material, 3/4" bars

| PART# | DESCRIPTION |
|-----------------|----------------|
| 557101 | Chrome plated |
| 557101BN | Brushed nickel |

| PART# | DESCRIPTION | BRACKETS ONLY |
|--------------|-------------------|----------------------|
| 4518 | 18" Complete unit | |
| 4518B | 18" Bar only | |
| 4524 | 24" Complete unit | |
| 4524B | 24" Bar only | 4518BR |
| 4526 | 30" Complete unit | (Fits all size bars) |
| 4526B | 30" Bar only | |
| 4527 | 36" Complete unit | |
| 4527B | 36" Bar only | |

TOILET PAPER HOLDER



- LYNCAR'S toilet paper holder are zinc chrome plated
- Sold as complete unit
- Also available replacement inserts sold bulk in bags of 100, white plastic

| PART# | DESCRIPTION |
|-------------|---|
| 4519 | Toilet paper holder complete |
| 4522 | Replacement roller 3/8, 5/8 white plastic |

TOOTHBRUSH & GLASS HOLDER



- LYNCAR'S glass & toothbrush holder
- Chrome plated zinc

| PART# | DESCRIPTION |
|-------------|---------------------------|
| 4520 | Toothbrush & glass holder |

E

NOTES

TUB & SHOWER

SECTION "F" KITCHEN & LAUNDRY INDEX

| | | | |
|------------------------------------|------|--------------------------------|------|
| Adapter Valves - 3 Way | F-7 | Hose Clamps | F-19 |
| Adapters - Aerators | F-15 | Humidifier Valves | F-27 |
| Adapters - Fittings | F-28 | Ice Maker Kits | F-26 |
| Add-A-Valve Stops | F-12 | Ice Maker Supply Lines | F-1 |
| Aerator - Swivel | F-14 | Laundry Faucets | F-23 |
| Aerator Adapters | F-15 | Laundry Hooks - Aluminum | F-22 |
| Aerator Decorative | F-15 | Lavatory legs | F-16 |
| Aerators | F-13 | Lavatory Tailpiece | F-5 |
| Aerators - Counter Displays | F-14 | Locknuts - Faucet | F-25 |
| Aerators - Vandal Resistant | F-14 | Needle Valves | F-27 |
| Angle Valves -Toilet | F-8 | Nut - Coupling Lavatory | F-5 |
| Bar Faucet | F-23 | Pantry Faucets | F-24 |
| Bath & Basin Stopper Chain | F-18 | Pex Supply Tubes | F-5 |
| Bead Chain | F-18 | Quarter Turn Valves | F-7 |
| Bolt - Sink Hold Down | F-17 | Repair Plate - Counter | F-25 |
| Braided Supplies | F-1 | Retrofit Stop Valves | F-12 |
| Caps - Vent & Fresh Air | F-20 | Rosettes | F-17 |
| Chain - Bath & Basin | F-18 | Rubber Stoppers | F-18 |
| Chain - Bead | F-18 | Sink Hold Down Bolt | F-17 |
| Clamps for Dryer Ducts | F-22 | Sink Strainers - Plastic | F-19 |
| Countertop Repair Plates | F-25 | Sink Strainers - Wire Mesh | F-19 |
| Covers, Faucet Hole | F-17 | Soap Dispenser | F-24 |
| Dishwasher - Aerator Adapter | F-16 | Stop Valves Compression | F-8 |
| Dishwasher Adapter | F-16 | Stop Valves Quarter Turn | F-8 |
| Dishwasher Connector Kit | F-19 | Stoppers - Rubber | F-18 |
| Dishwasher Hook Up Kit | F-6 | Straight Valves - Toilet | F-8 |
| Dishwasher Supply Lines | F-2 | Supply Lines | F-1 |
| Dispenser - Soap | F-24 | Supply Tubes - Plastic Pex | F-5 |
| Drain Floor Cover Aluminum | F-22 | Three Way Q/Turn Valves | F-7 |
| Drain Hose | F-19 | Toilet Installation Kits | F-6 |
| Drain Hose - Molded Hook | F-22 | Toilet Supply Lines | F-1 |
| Dryer Duct Clamps | F-22 | Valves - Humidifier | F-27 |
| Dryer Vent Kits | F-20 | Valves - Self Piercing | F-27 |
| Duct - Aluminum Dryer | F-21 | Vent Caps | F-20 |
| Ducting Products | F-20 | Vent Hoods | F-20 |
| Extenders for Faucet Shanks | F-25 | Washing Machine Pans | F-22 |
| Faucet - Shank Extenders | F-25 | Washing Machine Supply Lines | F-2 |
| Faucet Hole Covers | F-17 | Water Closet Installation Kits | F-6 |
| Faucet Hook Up Kits | F-6 | Water Heater Supply Lines | F-3 |
| Faucet Locknuts | F-25 | | |
| Faucet Supply Lines | F-1 | | |
| Faucets - Bar and Laundry | F-23 | | |
| Faucets Pantry | F-24 | | |
| Filter - Granulated | F-27 | | |
| Fluidmaster Supply Lines | F-4 | | |
| Fresh Air Intakes | F-20 | | |
| Hair Snares | F-19 | | |
| Hook Up Kits - Faucet & Dishwasher | F-6 | | |
| Hose - Dishwasher Drain | F-19 | | |

BRAIDED SUPPLIES

BRAIDED SUPPLY - TOILET



- Stainless steel #304 braided supply
- PVC inner hose (CSA approved)
- Plated brass nuts
- 100% pressure tested
- Logo and lot stamps
- Won't kink or crease
- Meets CSA B125.3 and ASSE A112.18.6 standards
- NSF 61 and cUPC approved



| PART# | DESCRIPTION |
|--------------|---|
| 55513 | 7/8" ballcock nut x 3/8" OD comp. x 9" |
| 55510 | 7/8" ballcock nut x 3/8" OD comp. x 12" |
| 55511 | 7/8" ballcock nut x 3/8" OD comp. x 16" |
| 55512 | 7/8" ballcock nut x 3/8" OD comp. x 20" |

BRAIDED SUPPLY - FAUCET



- Stainless steel #304 braided supply
- PVC inner hose (CSA approved)
- Plated brass nuts
- 100% pressure tested
- Logo and lot stamps
- Won't kink or crease
- Meets CSA B125.3 and ASSE A112.18.6 standards
- NSF 61 and cUPC approved



| PART# | DESCRIPTION |
|--------------|--------------------------------|
| 55503 | 1/2" IPS x 3/8" OD comp. x 9" |
| 55500 | 1/2" IPS x 3/8" OD comp. x 12" |
| 55501 | 1/2" IPS x 3/8" OD comp. x 16" |
| 55502 | 1/2" IPS x 3/8" OD comp. x 20" |
| 55504 | 1/2" IPS x 3/8" OD comp. x 30" |

BRAIDED SUPPLY - ICE MAKER



- Stainless steel #304 braided supply
- PVC inner hose (CSA approved)
- Plated brass nuts
- 100% pressure tested
- Logo and lot stamps
- Braided stainless steel
- Won't kink or crease
- Meets CSA B125.3 and ASSE A112.18.6 standards
- NSF 61 and cUPC approved

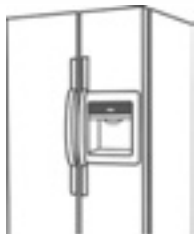

| PART# | DESCRIPTION |
|--------------|-------------------------------------|
| 55530 | 1/4" OD comp. x 1/4" OD comp. x 12" |
| 55532 | 1/4" OD comp. x 1/4" OD comp. x 36" |
| 55534 | 1/4" OD comp. x 1/4" OD comp. x 48" |
| 55536 | 1/4" OD comp. x 1/4" OD comp. x 60" |
| 55538 | 1/4" OD comp. x 1/4" OD comp. x 72" |

BRAIDED SUPPLIES

BRAIDED SUPPLY - WASHING MACHINE, STANDARD



- Stainless steel #304 braided supply
- PVC inner hose
- 100% tested
- Standard flow
- 1/4" I.D tube
- Logo & lot stamped
- Won't kink or crease
- Meets CSA B125.3
- cUPVC approved



| PART# | DESCRIPTION |
|-------|-------------------------|
| 55520 | 3/4" x 3/4" FGHT x 48" |
| 55522 | 3/4" x 3/4" FGHT x 60" |
| 55524 | 3/4" x 3/4" FGHT x 72" |
| 55526 | 3/4" x 3/4" FGHT x 144" |

BRAIDED SUPPLY - DISHWASHER



New style
part# 2155



Elbow with PEX fitting
part# 2159



Old style
part# 2161



- Stainless steel #304 braided supply
- PVC inner hose (CSA approved)
- Plated brass nuts
- 100% pressure tested
- Logo and lot stamps
- Won't Kink or crease
- Meets CSA B125.3 and ASSE A112.18.6 standards
- NSF 61 and cUPC approved



| PART# | DESCRIPTION |
|--------|--|
| 55507 | 3/8" OD comp. x 3/8" OD comp. x 12" |
| 55509 | 3/8" OD comp. x 3/8" OD comp. x 20" |
| 55514 | 3/8" OD comp. x 3/8" OD comp. x 48" with 90° elbow |
| 55516 | 3/8" OD comp. x 3/8" OD comp. x 60" with 90° elbow |
| 55518 | 3/8" OD comp. x 3/8" OD comp. x 72" with 90° elbow |
| 555141 | 3/8" OD comp. x 3/8" OD comp. x 48" with FHT/elbow |
| 555161 | 3/8" OD comp. x 3/8" OD comp. x 60" with FHT/elbow |
| 555181 | 3/8" OD comp. x 3/8" OD comp. x 72" with FHT/elbow |
| 2155 | Elbow 3/4" FHT x 3/8" MIP (available separately) |
| 2159 | Adaptor fitting 3/4" FHT x PEX brass elbow |
| 2161 | Connection fitting, 38 MIP x 3/8 comp. 90 |

BRAIDED SUPPLIES

BRAIDED SUPPLY - WASHING MACHINE, 90° ELBOW, PREMIUM



- Premium, oversized hose increased flow rates
- 90° elbow connect 3/4" FGHT
- Stainless steel #304 braided supply
- PVC inner hose
- 100% tested
- 3/8" I.D tube
- Logo & lot stamped
- Won't kink or crease
- Meets CSA B125.3
- NSF and cUPC approved



| PART# | DESCRIPTION |
|-------|-------------|
| 55598 | 60" long |
| 55599 | 72" long |

BRAIDED SUPPLIES FOR FAUCET (COUPLINGS)



- 1/2" IPS x 1/2" IPS
- Stainless steel #304 braided supply
- PVC inner hose (CSA approved)
- Plated brass nuts
- 100% pressure tested
- Logo and lot stamps
- Won't kink or crease
- Meets CSA B125.3 and ASSE A112.18.6 standards
- NSF 61 and cUPC approved



| PART# | DESCRIPTION |
|-------|------------------------|
| 55596 | 9" coupling connector |
| 55597 | 12" coupling connector |

BRAIDED SUPPLIES FOR FAUCET



- Used on builder series faucets
- Stainless steel #304 braided supply
- PVC inner hose (CSA approved)
- Plated brass nuts
- 100% pressure tested
- Logo and lot stamps
- Meets CSA B125.3 and ASSE A112.18.6 standards
- NSF 61 and cUPC approved



| PART# | DESCRIPTION |
|-------|------------------------------------|
| 55506 | 3/8" comp x 3/8" female comp x 12" |
| 55508 | 3/8" comp x 3/8" female comp x 20" |

BRAIDED SUPPLY - HOT WATER HEATER



- Meets CSA B125 standard
- Santoprene tube
- Stainless steel #304 braided supply
- NSF and cUPC approved



| PART# | DESCRIPTION |
|-------|--------------------------------|
| 55585 | 3/4" FIP x 3/4" FIP x 12" long |
| 55586 | 3/4" FIP x 3/4" FIP x 18" long |
| 55587 | 3/4" FIP x 3/4" FIP x 24" long |

BRAIDED SUPPLIES - FLUIDMASTER

DISHWASHER STAINLESS STEEL SUPPLY



- FLUIDMASTER brand
- Sleeve or bulk
- No-burst
- CSA approved

PART# DESCRIPTION

| | |
|--------------|------------|
| FM480 | 48" bulk |
| FM481 | 48" sleeve |
| FM460 | 60" bulk |
| FM461 | 60" sleeve |
| FM720 | 72" bulk |
| FM721 | 72" sleeve |

ICE MAKER STAINLESS STEEL SUPPLY

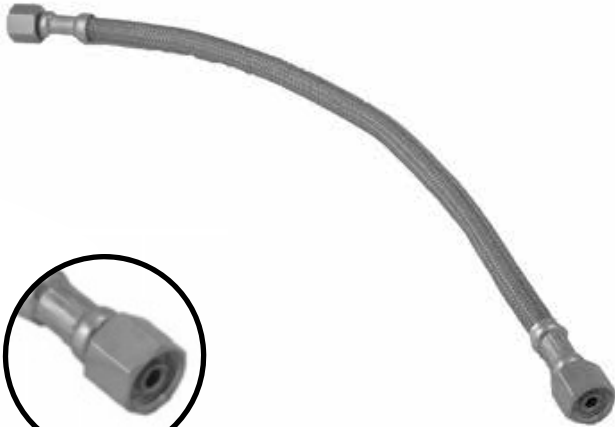

- FLUIDMASTER brand
- Sleeve packaged
- No-burst
- CSA approved

PART# DESCRIPTION

| | |
|---------------|-------------|
| FM260 | 60" sleeve |
| FM272 | 72" sleeve |
| FM2120 | 120" sleeve |

WASHING MACHINE S.S. SUPPLY



- FLUIDMASTER brand
- Bulk packaged
- No-burst
- CSA approved

PART# DESCRIPTION

| | |
|--------------|----------|
| FM360 | 60" bulk |
|--------------|----------|

KITCHEN & LAUNDRY

F

LAVATORY COUPLING NUT



| PART# | SIZE | MATERIAL |
|--------------|--------------|-------------|
| 1322 | 1/2" x 7/16" | Brass |
| 1322C | 1/2" x 7/16" | CP brass |
| 1326C | 1/2" x 3/8" | CP die cast |
| 1327C | 1/2" x 7/16" | CP die cast |
| 1327P | 1/2" x 7/16" | Die cast |
| 1328C | 1/2" x 1/2" | CP die cast |
| 1328P | 1/2" x 1/2" | Die cast |
| 1335 | 1/2" x 1/2" | Brass |
| 1335C | 1/2" x 1/2" | CP brass |

PLASTIC SUPPLY TUBES

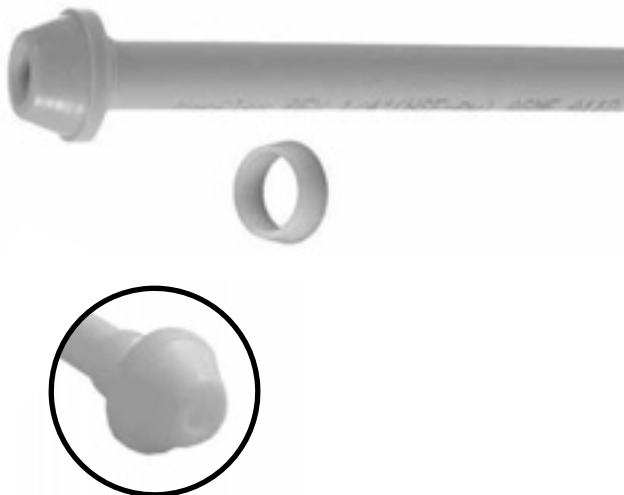

- PEX flexible supply tubes in 3/8" O.D. for faucets & toilet fill valves
- Pack 10 per bag
- With plastic ferrule

| PART# | LENGTH | DESCRIPTION |
|--------------|--------|------------------|
| 55590 | 12" | For fill valve |
| 55591 | 20" | For fill valve |
| 55592 | 30" | For fill valve |
| 55593 | 12" | For faucet valve |
| 55594 | 20" | For faucet valve |
| 55595 | 30" | For faucet valve |

LAVATORY TAILPIECE



- 1/4" IPS x 1-1/2" long brass
- Sold per pair

| PART# | DESCRIPTION |
|------------|--------------------|
| 857 | Lavatory tailpiece |

KITCHEN & LAUNDRY

INSTALLATION KITS

WATER CLOSET INSTALLATION KITS



Each package contains 1 of:

- part#82** (Brass closet bolts 5/16" x 2-1/4")
- part#55510** (12" toilet SS braided supply)

part#27082 includes **part#268** (wax gasket)

part#27083 includes **part#270** (wax gasket with horn)

| PART# | DESCRIPTION |
|-------|--|
| 27082 | Toilet installation kit |
| 27083 | Toilet installation kit, with wax gasket with horn |

1/4 TURN STRAIGHT STOPS FAUCET HOOK UP KITS

Each package contains 2 of:

- 1/4 turn straight stops
- Stainless steel braided supplies
- part#1230** (1/2" flanges)



| PART# | SUPPLY LENGTH | 1/4 STRAIGHT STOPS |
|-------|---------------|------------------------|
| 27085 | 12" | 1/2" comp x 3/8" comp |
| 27090 | 12" | 1/2" sweat x 3/8" comp |
| 27094 | 12" | 1/2" PEX x 3/8" comp |
| 27087 | 20" | 1/2" comp x 3/8" comp |
| 27091 | 20" | 1/2" sweat x 3/8" comp |
| 27095 | 20" | 1/2" PEX x 3/8" comp |

1/4 TURN ANGLE STOPS FAUCET HOOK UP KITS

Each package contains 2 of:

- 1/4 turn angle stops
- Stainless steel braided supplies
- part#1230** (1/2" flanges)

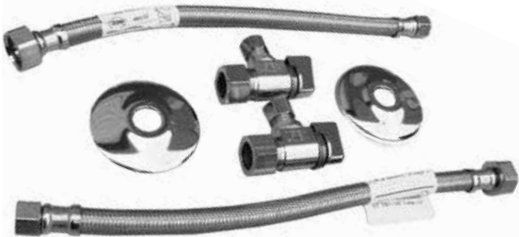

| PART# | SUPPLY LENGTH | 1/4 TURN ANGLE |
|-------|---------------|-----------------------|
| 27084 | 12" | 1/2" comp x 3/8" comp |
| 27092 | 12" | 1/2" Sweat x 3/8 comp |
| 27096 | 12" | 1/2" PEX x 3/8 comp |
| 27086 | 20" | 1/2" comp x 3/8 comp |
| 27093 | 20" | 1/2" Sweat x 3/8 comp |
| 27097 | 20" | 1/2" PEX x 3/8 comp |

DISHWASHER HOOK-UP KIT

Each package contains 1 of:

- part#506065** teflon tape
- part#3332** 1/4 turn straight stop 1/2" compression x 3/8" compression
- part#55516** 60" stainless steel braided supply
- part#27088** ABS fitting dw wye
- 1-1/2" x 1-1/2" x 3/4" barb



| PART# | DESCRIPTION |
|-------|------------------------|
| 27089 | Dishwasher hook up kit |

3 WAY QUARTER TURN VALVES

QUARTER TURN VALVE WITH TEE FITTING



- Quarter turn valve
- With tee fitting
- Chrome plated
- 3/8" or 1/4" connected
- 1 per bag
- cUPC approved valve

| PART# | DESCRIPTION |
|-------------|--|
| 3406 | 3/8" O.D. x 3/8" female O.D. x 3/8" O.D. |
| 3407 | 3/8" O.D. x 3/8" female O.D. x 1/4" O.D. |

QUARTER TURN 3 WAY VALVE



- 3 way valve
- Chrome plated
- Quarter turn
- Brass plug included
- 1 per bag
- cUPC approved

| PART# | DESCRIPTION |
|-------------|-----------------------------------|
| 3404 | 5/8" O.D. x 3/8" O.D. x 1/4" O.D. |
| 3405 | 3/8" O.D. x 3/8" O.D. x 1/4" O.D. |

QUARTER TURN VALVE PEX TEE FITTING



- Quarter turn valve
- Chrome plated fitting
- Use on dishwasher
- Use on humidifier
- 1 per bag
- cUPC approved valve

| PART# | DESCRIPTION |
|-------------|---------------------------------------|
| 3410 | 1/2" PEX x 1/2" PEX x 3/8" O.D. comp. |
| 3411 | 1/2" PEX x 1/2" PEX x 1/4" O.D. comp. |

ADAPTER TEE - 3 WAY



- Brass adapter valve
- Retrofit applications
- 1 per bag

| PART# | DESCRIPTION |
|-------------|--|
| 3415 | 3/8" female O.D. comp. x 3/8" comp. x 1/4" comp. |
| 3416 | 3/8" female O.D. comp. x 3/8" comp. x 3/8" comp. |

STOP VALVES

**QUARTER TURN STOP
ANGLE 1/2" COPPER SWEAT**



- Chrome plated
- Smooth 1/4 turn on/off action
- Brass ball & body
- PTFE seats
- Premium quality
- NSF 61.9 approval
- cUPC approved

**QUARTER TURN STOP
ANGLE 3/8" FIP**



- Chrome plated
- Smooth 1/4 turn on/off action
- Brass ball & body
- PTFE seats
- Premium quality
- NSF 61.9 approval
- cUPC approved

| PART# | DESCRIPTION |
|-------------|--------------------------------------|
| 3334 | 1/2" copper sweat x 3/8" compression |

| PART# | DESCRIPTION |
|-------------|-----------------------------|
| 3333 | 3/8" FIP x 3/8" compression |

**STOP VALVES ANGLE, COMPRESSION
1/2" SWEAT**



- Chrome plated
- Solid die cast plated handle
- Brass body
- Plated brass stem
- Premium quality
- cUPC approved

**STOP VALVES, COMPRESSION
ANGLE 3/8" FIP**



- Chrome plated
- Solid die cast plated handle
- Brass body
- Plated brass stem
- Premium quality
- cUPC approved

| PART# | DESCRIPTION |
|--------------|-------------------------------|
| 12655 | 1/2" Sweat x 3/8" compression |

| PART# | DESCRIPTION |
|--------------|-----------------------------|
| 12651 | 3/8" FIP x 3/8" compression |

STOP VALVES

**QUARTER TURN STOP STRAIGHT
3/8" F.I.P. INLET**



- Chrome plated
- Smooth 1/4 turn on/off action
- Brass ball & body
- PTFE seats
- Premium quality
- NSF 61.9 approval
- cUPC approved

**QUARTER TURN STOP STRAIGHT
1/2" COPPER SWEAT**



- Chrome plated
- Smooth 1/4 turn on/off action
- Brass ball & body
- PTFE seats
- Premium quality
- NSF 61.9 approval
- cUPC approved

| PART# | DESCRIPTION | PART# | DESCRIPTION |
|-------|--------------------------------------|-------|--------------------------------------|
| 3329 | 3/8" F.I.P. inlet x 3/8" compression | 3331 | 1/2" copper sweat x 3/8" compression |

**STOP VALVES, COMPRESSION
STRAIGHT 3/8" FIP**



- Chrome plated
- Solid die cast plated handle
- Brass body
- Plated brass stem
- Premium quality
- cUPC approved

**STOP VALVES STRAIGHT
1/2" SWEAT COMPRESSION**



- Brilliant chrome finish
- Solid die cast plated handle
- Brass body
- Plated brass stem
- Premium quality
- cUPC approved

| PART# | DESCRIPTION | PART# | DESCRIPTION |
|-------|-----------------------------|-------|-------------------------------|
| 12650 | 3/8" FIP x 3/8" compression | 12654 | 1/2" sweat x 3/8" compression |

STOP VALVES

**QUARTER TURN STOP
ANGLE 1/2" F.I.P. INLET**



- Chrome plated
- Smooth 1/4 turn on/off action
- Brass ball & body
- PTFE seats
- Premium quality
- NSF 61.9 approval
- cUPC approved

**QUARTER TURN STOP
STRAIGHT 1/2" F.I.P. INLET**



- Chrome plated
- Smooth 1/4 turn on/off action
- Brass ball & body
- PTFE seats
- Premium quality
- NSF 61.9 approval
- cUPC approved

| PART# | DESCRIPTION |
|-------------|--------------------------------------|
| 3335 | 1/2" F.I.P. inlet x 3/8" compression |

| PART# | DESCRIPTION |
|-------------|--------------------------------------|
| 3330 | 1/2" F.I.P. Inlet x 3/8" compression |

**STOP VALVES ANGLE
1/2" FIP x COMPRESSION**



- Chrome plated
- Solid die cast plated handle
- Brass body
- Plated brass stem
- Premium quality
- cUPC approved

**STOP VALVES STRAIGHT
1/2" FIP x COMPRESSION**



- Chrome plated
- Solid die cast plated handle
- Brass body
- Plated brass stem
- Premium quality
- cUPC approved

| PART# | DESCRIPTION |
|--------------|-----------------------------|
| 12653 | 1/2" FIP x 3/8" compression |

| PART# | DESCRIPTION |
|--------------|-----------------------------|
| 12652 | 1/2" FIP x 3/8" compression |

STOP VALVES

**QUARTER TURN STOP
ANGLE 5/8" OD COMPRESSION**



- Chrome plated
- Smooth 1/4 turn on/off action
- Brass ball & body
- PTFE seats
- Premium quality
- NSF 61.9 approval
- cUPC approved

**QUARTER TURN STOP STRAIGHT
5/8" COMPRESSION**



- Chrome plated
- Smooth 1/4 turn on/off action
- Brass ball & body
- PTFE seats
- Premium quality
- NSF 61.9 approval
- cUPC approved

| PART# | DESCRIPTION | PART# | DESCRIPTION |
|-------------|-------------------------------------|-------------|-------------------------------------|
| 3336 | 5/8" compression x 3/8" compression | 3332 | 5/8" compression x 3/8" compression |

**STOP VALVES ANGLE
5/8" COMPRESSION**



- Chrome plated
- Solid die cast plated handle
- Brass body
- Plated brass stem
- Premium quality
- cUPC approved

**STOP VALVES STRAIGHT
5/8" COMPRESSION**



- Chrome plated
- Solid die cast plated handle
- Brass body
- Plated brass stem
- Premium quality
- cUPC approved

| PART# | DESCRIPTION | PART# | DESCRIPTION |
|--------------|-------------------------------------|--------------|-------------------------------------|
| 12657 | 5/8" compression x 3/8" compression | 12656 | 5/8" compression x 3/8" compression |

STOP VALVES

ADD A STOP RETROFIT 1/4 TURN VALVE - STRAIGHT



- 1/4" turn smooth on/off
- Don't spend time removing an existing stop or fitting, especially in tight places
- It only takes seconds to thread the 1/4 turn retrofit ball stop onto an existing fitting or seized stop
- Premium quality
- cUPC approved

ADD A STOP RETROFIT 1/4 TURN VALVE - ANGLE



- 1/4" turn smooth on/off
- Don't spend time removing an existing stop or fitting, especially in tight places
- It only takes seconds to thread the 1/4 turn retrofit ball stop onto an existing fitting or seized stop
- Premium quality
- cUPC approved

| PART# | DESCRIPTION |
|-------------|-------------------------------------|
| 3326 | 3/8" compression x 3/8" compression |

| PART# | DESCRIPTION |
|-------------|-------------------------------------|
| 3325 | 3/8" compression x 3/8" compression |

QUARTER TURN STOP ANGLE, WITH 1/4" MALE THREAD



- 1/4 turn on/off valves
- Brass ball & body
- Forged quarter turn angle stops with 1/4" MPT connection
- Premium quality
- cUPC approved

QUARTER TURN STOP STRAIGHT WITH 1/4" MALE THREAD



- 1/4 turn on/off valves
- Brass ball & body
- Forged quarter turn angle stops with 1/4" MPT connection
- Premium quality
- cUPC approved

| PART# | DESCRIPTION |
|-------------|-----------------------------|
| 3560 | 1/4" MPT x 3/8" compression |

| PART# | DESCRIPTION |
|-------------|-----------------------------|
| 3562 | 1/4" MPT x 3/8" compression |

AERATORS

AERATOR PREMIUM QUALITY



| PART# | THREADS | STYLE | GPM @ 60 PSI |
|---------------|---------------------------|------------------------|--------------|
| 2100 | Male 15/16" -27 | Slotted | 2.0 |
| 2103 | Female 55/64" -27 | Slotted | 2.0 |
| 2105 | Dual 15/16" - 55/64" -27 | Slotted | 2.0 |
| 2105BN | Dual 15/16" - 55/64" - 27 | Slotted brushed nickel | 2.0 |
| 2105PB | Dual 15/16" - 55/64" - 27 | Slotted polished brass | 2.0 |
| 2104 | Dual 15/16" - 55/64"- 27 | Slotted WS | 1.5 |

AERATOR ECONOMY QUALITY



| PART# | THREADS | STYLE | GPM @ 60 PSI |
|-------------|-------------------------|----------------|--------------|
| 2120 | Male 15/16" -27 | Non-slotted | 2.0 |
| 2122 | Female 55/64" -27 | Non-slotted | 2.0 |
| 2124 | Dual 15/16" -55/64" -27 | Non-slotted | 2.0 |
| 2130 | Male 13/16" -27 | Non-slotted | 2.0 |
| 2131 | Female 13/16" -27 | Non-slotted | 2.0 |
| 2132 | Male 15/16" -27 | Non-slotted WS | 1.5 |
| 2133 | Female 55/64" -27 | Non-slotted WS | 1.5 |
| 2134 | Dual 15/16" -55/64" -27 | Non-slotted WS | 1.5 |
| 2135 | Female 55/64" -27 | Non-slotted WS | 1 |
| 2137 | Dual 15/16" -55/64" -27 | Non-slotted WS | 1 |
| 2138 | Male 15/16" -27 | Non-slotted WS | 1 |

AERATOR - 6 PACK TUBES



| PART# | TYPE | STYLE | GPM @ 60 PSI |
|--------------|-----------------------------------|----------------|--------------|
| 2103T | Premium - female 55/64" -27 | Slotted | 2.0 |
| 2105T | Premium - dual 15/16"-55/64" - 27 | Slotted | 2.0 |
| 2104T | Premium - dual 15/16"-55/64" - 27 | Slotted WS | 1.5 |
| 2120T | Economy - male 15/16" - 27 | Non-slotted | 2.0 |
| 2122T | Economy - female 55/64" - 27 | Non-slotted | 2.0 |
| 2124T | Economy - dual 15/16"-55/64" - 27 | Non-slotted | 2.0 |
| 2130T | Economy - male 13/16" - 27 | Non-slotted | 2.0 |
| 2132T | Economy - male 15/16" -27 | Non-slotted | 1.5 |
| 2133T | Economy - female 55/64" - 27 | Non-slotted WS | 1.5 |
| 2134T | Economy - dual 15/16"-55/64" - 27 | Non-slotted WS | 1.5 |

AERATORS

AERATOR - COUNTER DISPLAYS

24
Tubes
6 Aerators
per tube



- These displays are guaranteed to trigger an impulse purchase by the plumber!
- Small display generates BIG profits!

Slotted premium quality

| PART# | DUAL THREADS |
|-------|---|
| 2106 | Contains 144 - part#2105 |
| 2107 | Contains 144 - part#2104 (water saver) |

Non-slotted economy quality

| PART# | DUAL THREADS |
|-------|---|
| 2125 | Contains 144 - part#2124 |
| 2136 | Contains 144 - part#2134 (water saver) |

AERATOR - VANDAL RESISTANT



- Chrome plated brass
- Special key wrench included

| PART# | TYPE | FLOW | GPM @ 60PSI |
|-------|-----------------------|-------------|-------------|
| 2126 | Female - 55/64" - 27T | Water saver | .50 |
| 21261 | Female - 55/64" - 27T | Water saver | 1.0 |
| 2127 | Male - 15/16" - 27T | Water saver | .50 |
| 21271 | Male - 15/16" - 27T | Water saver | 1 |
| 2128 | Female - 55/64" - 27T | Standard | 2.2 |
| 2129 | Male - 15/16" - 27T | Standard | 2.2 |
| 2126K | Replacement key only | | |

AERATOR - SWIVEL



- Popular double jointed swivel aerators
- All white or white with chrome trim
- Counter display with 36 units

| PART# | TYPE | DESCRIPTION |
|--------|--|-------------------------|
| 2002 | Shower head - low flow | 1.5 gpm, CSA approved |
| 2002A | Single aerators - double | White with chrome trim |
| 2002B | Single aerators - double | All White |
| 2002D | Point of sale counter display | 18 - 2002A & 18 - 2002B |
| 2002DC | Point of sale counter display | 36 - 2002A |
| 2002VP | Shower head - low flow vandal proof | 1.5 gpm, CSA approved |

AERATORS & AERATOR ADAPTERS

PREMIUM DECORATIVE AERATOR , PYRAMID



- Pyramid style premium aerator
- Chrome finish
- 15/16 male thread
- 2.0 GPM
- Perfect match to classical & decorative faucets

| PART# | DESCRIPTION |
|-------|-----------------------|
| 1995 | Pyramid style aerator |

PREMIUM DECORATIVE, BELL



- Bell style premium aerator
- Chrome finish
- 15/16 male thread
- 2.0 GPM
- Perfect match to classical & decorative faucets

| PART# | DESCRIPTION |
|-------|--------------------|
| 1996 | Bell style aerator |

PREMIUM DECORATIVE AERATOR , FLUTE



- Flute style aerator
- Chrome finish
- 15/16 male thread
- 2.0 GPM
- Perfect match to classical & decorative faucets

| PART# | DESCRIPTION |
|-------|---------------------|
| 1997 | Flute style aerator |

AERATOR ADAPTER, DUAL THREAD FAUCET TO HOSE THREAD



- Threadsize: 55/64-27, 1516-24 x 3/4GHT

| PART# | DESCRIPTION |
|-------|-----------------------|
| 2260 | Faucet to hose thread |

AERATOR ADAPTER, W/ GARDEN HOSE THREAD

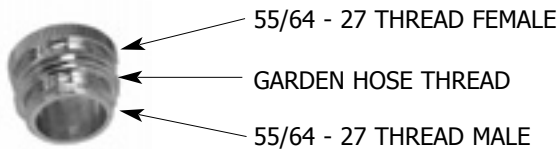

| PART# | DESCRIPTION |
|-------|--------------------|
| 2261 | Garden hose thread |

MALE ADAPTER, 15/16" - 27 TPI X 55/64" - 27 TPI



| PART# | DESCRIPTION |
|-------|-----------------------------------|
| 2262 | 15/16" - 27 TPI x 55/64" - 27 TPI |

KITCHEN & LAUNDRY

MALE ADAPTER, 13/16" - 27 TPI x 55/64" - 27 TPI



| PART# | DESCRIPTION |
|-------|-----------------------------------|
| 2263 | 13/16" - 27 TPI x 55/64" - 27 TPI |

FEMALE x MALE 55/64" - 27 TPI



| PART# | DESCRIPTION |
|-------|-------------------------------------|
| 2264 | Female 3/4" x male 55/64 x 27 TPI |
| 2265 | Female 13/16" x male 55/64 x 24 TPI |

FEMALE 55/64" - 27 TPI x FEMALE 15/16" - 24 TPI



| PART# | DESCRIPTION |
|-------|--|
| 2177 | Chrome plated brass female 55/64" - 27 TPI x female 15/16" - 24 TPI |

DISHWASHER ADAPTER



| PART# | DESCRIPTION |
|-------|--|
| 2266 | Dual thread dishwasher adapter w/aerator |
| 2178 | Female thread dishwasher adapter w/aerator |
| 2180 | Dual thread dishwasher adapter non-aerator |

LAVATORY LEGS

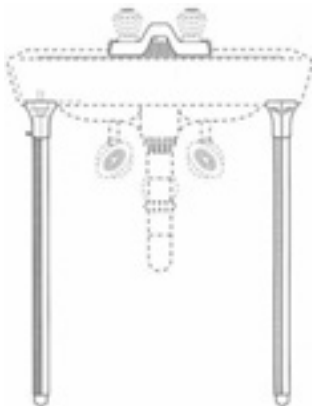

- Chrome plated
- 2" adjustment
- 30" overall length
- Boxed by the pair
- Installation instructions with each pair
- Adjustable to fit a variety of china & enamel lavatories

| PART# | DESCRIPTION |
|-------|---------------|
| 1250 | Lavatory legs |

KITCHEN & LAUNDRY

DEEP BASIN ROSETTE



- Stamped steel

FLAT BASIN ROSETTE



- Stamped steel

| PART# | DESCRIPTION |
|-------|--------------------|
| 1266 | Deep basin rosette |

| PART# | DESCRIPTION |
|-------|--------------------|
| 1268 | Flat basin rosette |

FAUCET HOLE COVERS



- Covers pre drilled holes on sink and counters

NUT - LOCK



- Sink strainer replacement nut in brass

| PART# | SIZE |
|-------|--------|
| 1274 | 2" |
| 1275 | 1-3/4" |

| PART# | SIZE | MATERIAL |
|-------|--------|-----------------------|
| 1312 | 3-3/8" | Brass basket strainer |

SNAP-IN FAUCET HOLE COVER



- Chrome plated
- Fits 1-1/2" hole
- Holes in china or stainless steel fixtures vary in diameter
- This cover fits most but not all manufacturers

SINK HOLD DOWN BOLT



- Hold down sinks
- Pack of 4 or bulk available
- 3-5/16" long x 1/4" diameter
- With side clip

| PART# | DESCRIPTION |
|-------|---------------------------|
| 1279 | Snap-in faucet hole cover |

| PART# | DESCRIPTION |
|-------|------------------------------|
| 4517 | Sink hold down bolt - 4 pack |
| 4517Q | Sink hold down bolt - bulk |

KITCHEN & LAUNDRY

STOPPER - FIT ALL RUBBER



| PART# | BULK PART# | DESCRIPTION |
|-------|------------|--------------------|
| 12000 | 12000Q | Basin 1" to 1-3/8" |
| 12001 | 12001Q | Tub 1-1/2" to 2" |

RUBBER STOPPER



| PART# | BULK PART# | SIZE |
|-------|------------|--------|
| 12005 | 12005Q | 1" |
| 12006 | 12006Q | 1-1/8" |
| 12007 | 12007Q | 1-1/4" |
| 12008 | 12008Q | 1-3/8" |
| 12009 | 12009Q | 1-1/2" |
| 12010 | 12010Q | 1-5/8" |
| 12011 | 12011Q | 1-3/4" |
| 12012 | 12012Q | 1-7/8" |

BEAD CHAIN # 10



| PART# | MATERIAL | DESCRIPTION |
|-------|--------------|--------------------|
| 1122 | Plated steel | 250 ft. roll |
| 1124 | Plated brass | 250 ft. roll |
| 1130 | Plated steel | Connector type "B" |
| 1131 | Plated steel | Connector type "A" |

BATH & BASIN STOPPER CHAIN

- "B" Connector with loop ring
- Stoppers not included



| PART# | MATERIAL | DESCRIPTION |
|-------|--------------|--|
| 1123 | Plated steel | 11" - basin w/ "B" connector |
| 1123A | Plated steel | 11" - basin w/ "B" connector & loop ring |
| 1125 | Plated steel | 15" - bath w/ "B" connector |
| 1125A | Plated steel | 15" - bath w/ "B" connector & loop ring |
| 1118 | Plated brass | 11" - basin w/ "B" connector |
| 1118A | Plated brass | 11" - basin w/ "B" connector & loop ring |
| 1119 | Plated brass | 15" - bath w/ "B" connector |
| 1119A | Plated brass | 15" - bath w/ "B" connector & loop ring |

KITCHEN & LAUNDRY

SINK STRAINER, WIRE MESH



- Chrome plated wire mesh screens
- Contains 3 strainers, 2", 2 3/4" and 3 1/2" wide
- For use in sinks & bathtubs
- Allows water to drain while catching debris, food, hair etc.
- Displayed packaged

SINK STRAINER, PLASTIC



- White plastic screens for sink and bath
- Contains 2" and 2-3/4" sizes
- Allows water to drain while catching debris, food, hair etc.
- Display packaged

| PART# | DESCRIPTION |
|--------------|------------------------|
| 21822 | Wire mesh, 3 piece set |

| PART# | DESCRIPTION |
|--------------|------------------------------------|
| 21820 | Plastic strainers, large and small |

HAIR SNARE



- LYNCAR'S hair snare
- White PVC
- Packaged for display
- Use in household drains

HOSE CLAMP



- All stainless steel hose clamp
- Stainless housing and screw
- 10 pieces per box
- For full line of LYNCAR'S hose clamps see **page J-5**

| PART# | DESCRIPTION |
|--------------|-------------|
| 21817 | Hair snare |

| PART# | DESCRIPTION |
|--------------|-------------|
| 63010 | 5/8" clamp |
| 63016 | 7/8" clamp |

DISHWASHER DRAIN HOSE



- Box packaged
- Made of braided rubber with a rayon tire grade cord
- It is an extremely durable hose & resists kinking

DISHWASHER CONNECTOR KIT



- Rigid construction
- Will not collapse

| PART# | SIZE | LENGTH |
|------------|------|--------|
| 506 | 5/8" | 50' |
| 507 | 7/8" | 50' |

| PART# | DESCRIPTION |
|------------|--------------------------|
| 496 | Dishwasher connector kit |

DUCTING

FRESH AIR INTAKES W/ SCREEN



- To allow fresh air to enter the home
- 1/4" galvanized screen included.
- For fireplaces, H.E. furnaces



| PART# | DESCRIPTION |
|-------|----------------------|
| 1716W | 3" new style - white |
| 1716B | 3" new style - brown |
| 1717W | 4" new style - white |
| 1717B | 4" new style - brown |

DRYER VENT KIT - PRO FLEX



- With 4" x 8' aluminum duct pipe, wall flange & clamps
- UL listed recommended for gas & electric dryers



| PART# | DESCRIPTION |
|-------|---------------------------|
| 1716 | Dryer vent kit - pro flex |

VENT CAPS REPLACEMENT



- Flat screen(louvered) or traditional



| PART# | DESCRIPTION |
|-------|--------------------------------------|
| 1696W | 4" traditional - white |
| 1696B | 4" traditional - brown |
| 1697W | 4" louvered - white |
| 1697B | 4" louvered - brown |
| 1698W | 4" fresh air (molded screen) - white |
| 1698B | 4" fresh air (molded screen) - brown |

VENT HOOD- TRADITIONAL STYLE



- With 4" aluminum duct pipe
- Weather resistant
- Paintable
- Narrow profile
- Prevents drafts



| PART# | COLOUR |
|-------|--------|
| 1718W | White |
| 1718B | Brown |

VENT HOOD - LOUVERED STYLE



- With 4" aluminum duct pipe



| PART# | DESCRIPTION |
|-------|-------------|
| 1721W | White |
| 1721B | Brown |

DUCTING

DUCT - PRO FLEX DRYER TRANSITION



- Box packaged
- 4" diameter x 8 feet long
- UL approved, listed & marked

| PART# | DESCRIPTION |
|-------------|----------------------------------|
| 1714 | Duct - PRO FLEX Dryer transition |

DUCT - FLEXIBLE ALUMINUM FOIL



- Box packaged
- 4" diameter x 25 feet long
- Recommended for venting electric dryer & air intake
- cUL listed

| PART# | DESCRIPTION |
|-------------|----------------|
| 1720 | 4" x 25' boxed |

DUCT - FLEXIBLE ALUMINUM



- Box packaged
- 4" diameter x 10' long
- Recommended for venting gas dryer
- cUL listed

| PART# | DESCRIPTION |
|-------------|----------------|
| 1694 | 4" x 10' boxes |

DUCT - RESIDENTIAL INSULATED



- 4" diameter x 25 feet long
- Bulk packaged
- Recommended for venting
- cUL, UL approved, listed & marked

| PART# | DESCRIPTION |
|--------------|-------------|
| 16955 | 4" x 25' |

DUCTING

DRYER VENT KIT - INDOOR



- Used for electric dryers when outdoor venting is not possible
- Great for apartments and R.V's
- 1 per box & 12 per case
- cUL approved PROFLEX dryer duct included



PART# DESCRIPTION

1719 Dryer vent kit - indoor

CLAMPS FOR DRYER DUCTS



- Extra clamps for mounting dryer duct



PART# DESCRIPTION

1724 3"- 4" adjustable plastic clamp

1723 4" tension metal clamp

DRAIN COVER ALUMINUM



- Aluminum floor drain cover
- Heavy duty construction
- 1/4" thick x 4-1/2" diameter

PART# DESCRIPTION

1216 Drain cover replacement

WASHING MACHINE PAN



- High impact white polypropylene Plastic Matte finish
- Will not rust, corrode or crack
- Includes PVC drain fitting
- Bottom or side outlet (not pre-cut)
- 1" drain can pass all codes
- Easy to install
- OD 27" x 30" x 2-1/8"
- Only sold as boxes of 6

PART# DESCRIPTION

11506 Washing machine pan

LAUNDRY HOOKS - ALUMINUM



- Aluminum hooks for drain on laundry
- Available in 3/4" or 1" diameter sizes

PART# SIZE

12605 3/4" x 11"

12610 1" x 11"

MOLDED HOOK DRAIN HOSE



- Molded rubber drain hose
- With expanded end
- Will fit drain outlets of 3/4", 7/8" & 1" sizes

PART# DESCRIPTION

12600 Molded hook drain hose

FAUCET - BAR & LAUNDRY

FAUCET - LAUNDRY TRAY



- Laundry tray faucet, 4" centres
- Full metal construction, brass waterways
- Double O-Ring Spout
- Tubular spout with hose threads
- Metal chrome handles
- Trap seal primer
- Removeable aerator
- Compression cartridges



| PART# | DESCRIPTION |
|-------|-------------|
|-------|-------------|

| | |
|--------------|----------------------|
| 33200 | Faucet complete |
| 33201 | Handles - hot & cold |
| 33202 | Cartridge |

FAUCET - LAUNDRY BRASS



- All brass laundry tray faucet
- 4" centres
- 6" tubular spout with hose threads
- EMCO style red & blue laundry handles
- Mounting bracket included
- Trap seal primer
- Removeable aerator
- Compression cartridges
- CSA approved



| PART# | DESCRIPTION |
|-------|-------------|
|-------|-------------|

| | |
|--------------|-----------------|
| 33205 | Faucet complete |
| 2013 | Red handle |
| 2014 | Blue handle |
| 899 | Cartridge |

FAUCET - WALL MOUNT WITH SOAP DISH



- Chrome plated cast brass body
- 6" cast spout
- Complete with soap dish
- Lever handles
- Rear flanges

| PART# | DESCRIPTION |
|-------|-------------|
|-------|-------------|

| | |
|--------------|------------------------------------|
| 21815 | Faucet - wall mount with soap dish |
|--------------|------------------------------------|

BAR FAUCET



- Polished chrome plated metal
- 4" centres
- 6" goose neck spout
- Brass waterways
- Metal handles
- CSA approved



| PART# | DESCRIPTION |
|-------|-------------|
|-------|-------------|

| | |
|--------------|----------------------|
| 34295 | Faucet complete |
| 33201 | Handles - hot & cold |
| 33202 | Cartridge |

PANTRY FAUCETS

PANTRY FAUCET - LONG REACH

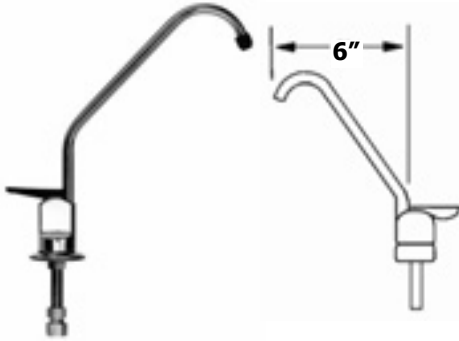

- 7/16" diameter hole required
- 1/4" compression connection
- Chrome
- cUPC approved

| PART# | DESCRIPTION |
|--------|----------------------------|
| 2040LR | Pantry faucet - long reach |

PANTRY FAUCET - TALL SPOUT

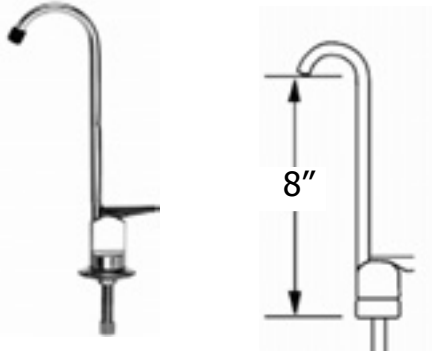

- 7/16" diameter hole required
- 1/4" compression connection
- Chrome

| PART# | DESCRIPTION |
|--------|----------------------------|
| 2040TS | Pantry faucet - tall spout |

PANTRY FAUCET - THE ORIGINAL

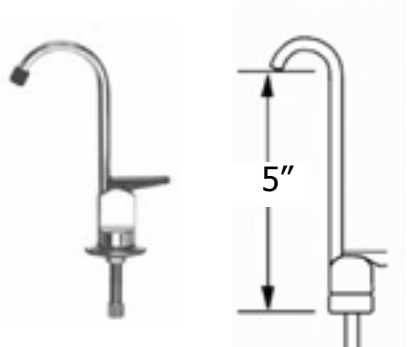

- 7/16" diameter hole required
- cUPC approved

| PART# | FINISH | COMPRESSION CONNECTION |
|--------|----------------|------------------------|
| 2040 | Chrome | 1/4" |
| 2040BN | Brushed nickel | 1/4" |
| 2041 | Chrome | 3/8" |

LIQUID SOAP DISPENSER UNIVERSAL QUALITY REPLACEMENT



- 2" spout
- 10" length
- Chrome plated or brushed nickel brass pump
- Mounts through counter
- Unbreakable poly bottle
- Holds 7 oz.

| PART# | DESCRIPTION |
|--------|------------------|
| 2042 | Chrome |
| 2042BN | Brushed nickel |
| 2042P | Replacement pump |

KITCHEN & LAUNDRY

F

QUICK DECK PLATE

Retrofit Deck Repair Plate



Deck Repair Plate

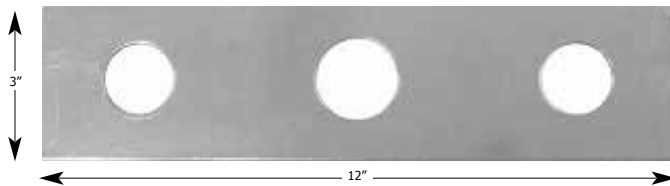

- 2 great time savers for the maintenance plumber 8" faucet deck repair plate
- This deck backer plate provides a solid foundation to secure 8" centre faucets.
- Ideal for securing faucets to counter tops with over size & irregular holes or uneven under-the counter mounting surfaces. 14GA
- Galvanized steel
- Select the retrofit deck repair plate for those situations when removing & reinstalling the supply lines are not practical
- Finish: galvanized steel painted red

| PART# | DESCRIPTION |
|--------------|-----------------------|
| 1214R | Retrofit repair plate |
| 1214 | Deck repair plate |

FAUCET LOCKNUT



- Plastic 1/2 IPS
- For bottom thread on faucet

| PART# | DESCRIPTION |
|--------------|-----------------------|
| 4410 | Faucet Locknut - pair |
| 4410Q | Faucet Locknut - bulk |

SHANK EXTENDERS



- Add additional threads to faucet to get below deep counters
- Answer to a common problem "I need more length to fit the granite top"
- 1-1/2" overall
- Seals with ID O-Rings
- Solid brass

| PART# | DESCRIPTION |
|--------------|-----------------------|
| 33216 | Shank extenders, pair |

KITCHEN & LAUNDRY

ICE MAKER HOOK-UP KITS

ICE MAKER KIT WITH POLY TUBING



For use on refrigerators with automatic icemakers. Also use on humidifiers.

KIT CONTAINS

- 1. 1/4" x 25' poly tubing
- 1. self-piercing needle valve
- 1. 1/4" compression union
- 2. 1/4" brass insert sleeves
- 2. 1/4" delrin insert sleeves

| PART# | DESCRIPTION |
|--------------|--------------------|
| 2045 | Poly hook - up kit |

ICE MAKER KIT WITH COPPER TUBING



For use on refrigerators with automatic icemakers. Also use on humidifiers.

KIT CONTAINS

- 1. 1/4" x 25' copper tubing
- 1. self piercing needle valve
- 1. 1/4" compression union
- 1. 1/4" compression male
- 1. 1/4" 90° compression elbow

| PART# | DESCRIPTION |
|--------------|--------------------|
| 2049 | Copper hook up kit |

ICEMAKER ACCESSORIES

SELF PIERCING NEEDLE VALVES



- For 3/8" To 1" copper tube
- KIT CONTAINS:
 Needle valve
 Saddle clamp
 Nuts
 Bolts

| PART# | DESCRIPTION |
|--------------|------------------------------------|
| 2162 | Self piercing needle valves |
| 2162Q | Self piercing needle valves - bulk |

VALVE - SELF-PIERCING SADDLE / HUMIDIFIER



- Easy to install
- Will not flatten pipe
- 1/4" compression outlet
- Fits 3/8", 7/16", 5/8" copper

| PART# | DESCRIPTION |
|--------------|-----------------------------------|
| 2165 | Self piercing saddle valve |
| 2165Q | Self piercing saddle valve - bulk |

CARBON FILTER - GRANULATED



- Filters contain granulated carbon for taste & odor removal from municipal drinking water.
- Container - Polypropylene
- Media- activated carbon
- Filter/screen - Polyester Felt
- Micron size - 20
- Flow rate - 1 GPM @ 60 PSI
- Life span - 3-6 months
- Effective filtering - 2000 GAL.
- Temp rating - 120° F
- Pressure rating - 125 PSI

| PART# | DESCRIPTION |
|-------------|---------------|
| 2060 | Carbon filter |

FITTING ADAPTERS

COMPRESSION x COMPRESSION



- Chrome brass finish

| PART# | TYPE | DESCRIPTION |
|-------|---------------|-------------------------------------|
| 12770 | Straight body | 3/8" compression x 5/8" compression |
| 12771 | Straight body | 1/2" compression x 5/8" compression |
| 12772 | Angle body | 3/8" compression x 5/8" compression |
| 12773 | Angle body | 1/2" compression x 5/8" compression |

SWEAT x COMPRESSION



- Brass finish

| PART# | TYPE | DESCRIPTION |
|-------|---------------|-------------------------------|
| 12777 | Straight body | 1/2" sweat x 3/8" compression |
| 12778 | Angle body | 1/2" sweat x 3/8" compression |

FIP x COMPRESSION



- Chrome brass finish

| PART# | TYPE | DESCRIPTION |
|-------|---------------|-----------------------------|
| 12779 | Straight body | 3/8" FIP x 3/8" compression |
| 12783 | Straight body | 1/2" FIP x 3/8" compression |
| 12780 | Angle body | 3/8" FIP x 3/8" compression |
| 12784 | Angle body | 1/2" FIP x 3/8" compression |

MIP x SWEAT



- Rough brass finish

| PART# | DESCRIPTION |
|-------|-----------------------|
| 12804 | 1/2" MIP x 1/2" sweat |
| 12805 | 3/4" MIP x 1/2" sweat |
| 12806 | 3/8" MIP x 1/2" sweat |
| 12807 | 3/8" MIP x 3/8" sweat |

SEE PAGE G-6 FOR PEX X COMPRESSION

FITTING ADAPTERS

FAUCET ADAPTER



- Chrome brass finish

| PART# | DESCRIPTION |
|--------------|-----------------------------|
| 12776 | 1/2" FIP x 5/8" compression |

COMPRESSION UNION



- Chrome brass finish

| PART# | DESCRIPTION |
|--------------|-------------------------------------|
| 12775 | 1/4" compression x 1/4" compression |
| 12774 | 3/8" compression x 3/8" compression |
| 12789 | 1/2" compression x 1/2" compression |
| 12790 | 5/8" compression x 5/8" compression |

FIP x SWEAT



- Rough brass finish

| PART# | DESCRIPTION |
|--------------|-----------------------|
| 12800 | 1/2" FIP x 1/2" sweat |
| 12801 | 3/8" FIP x 3/8" sweat |
| 12802 | 3/4" FIP x 1/2" sweat |
| 12803 | 3/8" FIP x 1/2" sweat |

MIP x COMPRESSION



- Chrome brass finish

| PART# | TYPE | DESCRIPTION |
|--------------|---------------|-----------------------------|
| 12787 | Straight body | 1/4" MIP x 3/8" compression |
| 12781 | Straight body | 3/8" MIP x 3/8" compression |
| 12785 | Straight body | 1/2" MIP x 3/8" compression |
| 12788 | Straight body | 1/4" MIP x 1/4" compression |
| 12782 | Angle body | 3/8" MIP x 3/8" compression |
| 12786 | Angle body | 1/2" MIP x 3/8" compression |

SECTION "G" PUSHFIT & PEX INDEX

| | | | |
|----------------------------------|------|---------------------------|------|
| Adapters - PEX Fittings | G-6 | Valve - Pushfit | G-1 |
| Angle Valves - PEX | G-12 | Valve - Quarter Turn, PEX | G-14 |
| Ball Valve - EasyGrip | G-4 | Valve - Sillcock, PEX | G-14 |
| Ball Valve - Mini PEX | G-13 | | |
| Ball Valve - PEX | G-13 | | |
| Ball Valve - Sweat x PEX | G-13 | | |
| Brass PEX Fittings | G-5 | | |
| Clamps - PEX | G-8 | | |
| EasyGrip Ball Valves | G-4 | | |
| EasyGrip Fittings | G-2 | | |
| EasyGrip Valves | G-1 | | |
| Faucet - Sediment, PEX | G-14 | | |
| Fittings - Adapters PEX | G-6 | | |
| Fittings - EasyGrip | G-2 | | |
| Fittings - PEX Brass | G-5 | | |
| Fittings - PEX Plastic | G-9 | | |
| Fittings - Pushfit | G-2 | | |
| Frost Free Faucets - PEX End | G-13 | | |
| J Clips for Pex | G-8 | | |
| Lawn Faucets - PEX End | G-13 | | |
| OETIKER Pex Clamp | G-11 | | |
| PEX Ball Valve - Brass Mini | G-13 | | |
| PEX Ball Valve - Mini | G-13 | | |
| PEX Ball Valves | G-13 | | |
| PEX Bend Support | G-7 | | |
| PEX Clamp Stainless - LynCar | G-11 | | |
| PEX Clamps | G-8 | | |
| PEX Clinch Clamp - OETIKER | G-11 | | |
| PEX Copper Rings | G-11 | | |
| PEX Fittings | G-5 | | |
| PEX Fittings - Plastic | G-9 | | |
| PEX J Clamp | G-8 | | |
| PEX Shower Elbow | G-8 | | |
| PEX Stub Out Elbows | G-11 | | |
| PEX Valves | G-12 | | |
| PEX Valves - Low pressure Garden | G-14 | | |
| Plastic PEX Fittings | G-9 | | |
| Pushfit Fittings | G-2 | | |
| Pushfit Valves | G-1 | | |
| Quarter Turn Valves - PEX | G-12 | | |
| Rings - for PEX Copper | G-11 | | |
| Sediment Faucet - PEX End | G-14 | | |
| Shower Elbow - PEX | G-8 | | |
| Sillcock Valve - PEX end | G-14 | | |
| Straight Valves - PEX | G-12 | | |
| Stub Out Elbows - PEX | G-11 | | |
| Support - PEX Pipe | G-7 | | |

PUSHFIT STOP VALVES

EASYGRIP STOP VALVE ANGLE 3/8" COMP



- Designed to simplify pipe installation
- Allows users to connect pipe in seconds
- Instant pushfit connection for ease of use
- Certified to 200 PSI and 200°F (93°C)
- Fits OD controlled CPVC, PEX and copper pipe
- Body composed of solid DZR brass
- Chrome plated
- Supplied with insert(s)
- 1 per bag packaging
- cUPC approved

EASYGRIP STOP VALVE STRAIGHT 3/8" COMP



- Designed to simplify pipe installation
- Allows users to connect pipe in seconds
- Instant pushfit connection for ease of use
- Certified to 200 psi and 200°F(93°C)
- Fits OD controlled CPVC, PEX and copper pipe
- Body composed of solid DZR brass
- Chrome plated
- Supplied with insert(s)
- 1 per bag packaging
- cUPC approved

| PART# | DESCRIPTION | PART# | DESCRIPTION |
|-------|---------------------------------|-------|---------------------------------|
| 69740 | 1/2" pushfit x 3/8" compression | 69742 | 1/2" pushfit x 3/8" compression |

EASYGRIP STOP VALVE, 3 WAY



- Designed to simplify pipe installation
- Allows users to connect pipe in seconds
- Instant pushfit connection for ease of use
- Certified to 200 PSI and 200°F (93°C)
- Fits OD controlled CPVC, PEX and copper pipe
- Body composed of solid DZR brass
- Chrome plated
- Supplied with insert(s)
- 1 per bag packaging
- cUPC approved

EASYGRIP STOP VALVE, 3 WAY



- Designed to simplify pipe installation
- Allows users to connect pipe in seconds
- Instant pushfit connection for ease of use
- Certified to 200 PSI and 200°F(93°C)
- Fits OD controlled CPVC, PEX and copper pipe
- Body composed of solid DZR brass
- Chrome plated
- Supplied with insert(s)
- 1 per bag packaging
- cUPC approved

| PART# | DESCRIPTION | PART# | DESCRIPTION |
|-------|--|-------|--|
| 69747 | 1/2" pushfit x 3/8" x 3/8" compression | 69748 | 1/2" pushfit x 1/4" x 3/8" compression |

EASYGRIP STOP VALVE STRAIGHT 1/4" COMP



- Designed to simplify pipe installation
- Allows users to connect pipe in seconds
- Instant pushfit connection for ease of use
- Certified to 200 PSI and 200°F (93°C)
- Fits OD controlled CPVC, PEX and copper pipe
- Body composed of solid DZR brass
- Chrome plated
- Supplied with insert(s)
- 1 per bag packaging
- cUPC approved

EASYGRIP STOP VALVE ANGLE 1/4" COMP



- Designed to simplify pipe installation
- Allows users to connect pipe in seconds
- Instant pushfit connection for ease of use
- Certified to 200 PSI and 200°F (93°C)
- Fits OD controlled CPVC, PEX and copper pipe
- Body composed of solid DZR brass
- Chrome plated
- Supplied with insert(s)
- 1 per bag packaging
- cUPC approved

| PART# | DESCRIPTION | PART# | DESCRIPTION |
|-------|---------------------------------|-------|---------------------------------|
| 69746 | 1/2" pushfit x 1/4" compression | 69744 | 1/2" pushfit x 1/4" compression |

PUSHFIT FITTINGS

EASYGRIP TEE



- Designed to simplify pipe installation
- Allows users to connect pipe in seconds
- Instant pushfit connection for ease of use
- Certified to 200 PSI and 200°F (93°C)
- Fits OD controlled CPVC, PEX and Copper pipe
- Body composed of solid DZR Brass
- Supplied with insert(s)
- cUPC and NSF approved

EASYGRIP END CAP



- Designed to simplify pipe installation
- Allows users to connect pipe in seconds
- Instant pushfit connection for ease of use
- Certified to 200 PSI and 200°F (93°C)
- Fits OD controlled CPVC, PEX and Copper pipe
- Body composed of solid DZR Brass
- Supplied with insert(s)
- cUPC and NSF approved

| PART# | DESCRIPTION |
|-------|------------------------------|
| 69713 | 1/2" x 1/2" x 1/2" tee |
| 69714 | 3/4" x 3/4" x 3/4" tee |
| 69715 | 3/4" x 3/4" x 1/2" red - tee |
| 69716 | 3/4" x 1/2" x 3/4" red - tee |
| 69717 | 3/4" x 1/2" x 1/2" red - tee |
| 69720 | 1" x 1" x 1" tee |
| 69723 | 1" x 1" x 3/4" red - tee |

| PART# | DESCRIPTION |
|-------|--------------|
| 69718 | 1/2" end cap |
| 69719 | 3/4" end cap |
| 69727 | 1" end cap |

EASYGRIP STRAIGHT COUPLING



- Designed to simplify pipe installation
- Allows users to connect pipe in seconds
- Instant pushfit connection for ease of use
- Certified to 200 PSI and 200°F (93°C)
- Fits OD controlled CPVC, PEX and copper pipe
- Body composed of solid DZR brass
- Supplied with insert(s)
- cUPC and NSF approved

EASYGRIP LONG REPAIR SLIP COUPLING



- Designed to simplify pipe installation
- Allows users to connect pipe in seconds
- Instant pushfit connection for ease of use
- Certified to 200 PSI and 200°F (93°C)
- Fits OD controlled CPVC, PEX and copper pipe
- Body composed of solid DZR brass
- Supplied with insert(s)
- cUPC and NSF approved

| PART# | DESCRIPTION |
|-------|-------------------------------|
| 69700 | 1/2" coupling |
| 69701 | 3/4" coupling |
| 69722 | 1" coupling |
| 69702 | 3/4" x 1/2" reducing coupling |
| 69721 | 1" x 3/4" reducing coupling |

| PART# | DESCRIPTION |
|-------|------------------|
| 69735 | 1/2" repair slip |
| 69736 | 3/4" repair slip |
| 69737 | 1" repair slip |

PUSHFIT FITTINGS

EASYGRIP FEMALE IPS STRAIGHT CONNECTOR



- Designed to simplify pipe installation
- Allows users to connect pipe in seconds
- Instant pushfit connection for ease of use
- Certified to 200 PSI and 200°F (93°C)
- Fits OD controlled CPVC, PEX and copper pipe
- Body composed of solid DZR brass
- Supplied with insert(s)



| PART# | DESCRIPTION |
|--------------|------------------|
| 69703 | 1/2" x 1/2" FNPT |
| 69704 | 3/4" x 3/4" FNPT |
| 69705 | 1/2" x 3/4" FNPT |
| 69725 | 1" x 1" FNPT |

EASYGRIP MALE IPS STRAIGHT CONNECTOR



- Designed to simplify pipe installation
- Allows users to connect pipe in seconds
- Instant pushfit connection for ease of use
- Certified to 200 PSI and 200°F (93°C)
- Fits OD controlled CPVC, PEX and copper pipe
- Body composed of solid DZR brass
- Supplied with insert(s)



| PART# | DESCRIPTION |
|--------------|------------------|
| 69706 | 1/2" x 1/2" MNPT |
| 69707 | 3/4" x 3/4" MNPT |
| 69708 | 1/2" x 3/4" MNPT |
| 69726 | 1" x 1" MNPT |

EASYGRIP DROP EAR ELBOW



- Designed to simplify pipe installation
- Allows users to connect pipe in seconds
- Instant pushfit connection for ease of use
- Certified to 200 psi and 200°F (93°C)
- Fits OD controlled CPVC, PEX and copper pipe
- Body composed of solid DZR brass
- Supplied with insert(s)



| PART# | DESCRIPTION |
|--------------|------------------|
| 69712 | 1/2" x 1/2" FNPT |

EASYGRIP ELBOW



- Designed to simplify pipe installation
- Allows users to connect pipe in seconds
- Instant pushfit connection for ease of use
- Certified to 200 psi and 200°F (93°C)
- Fits OD controlled CPVC, PEX and copper pipe
- Body composed of solid DZR brass
- Supplied with insert(s)



| PART# | DESCRIPTION |
|--------------|-------------------|
| 69709 | 1/2" x 1/2" elbow |
| 69710 | 3/4" x 3/4" elbow |
| 69711 | 3/4" x 1/2" elbow |
| 69724 | 1" x 1" elbow |

EASYGRIP DISCONNECT TOOL



- Easy to use for removal of pipe from EASYGRIP fittings

| PART# | DESCRIPTION |
|--------------|-------------|
| 69731 | 1/2" |
| 69732 | 3/4" |
| 69733 | 1" |

PUSHFIT FITTINGS

EASYGRIP BALL VALVE



- Designed to simplify pipe installation
- Allows users to connect pipe in seconds
- Instant pushfit connection for ease of use
- Certified to 200 PSI and 200°F (93°C)
- Fits OD controlled CPVC, PEX and copper pipe
- Body composed of solid DZR brass
- Supplied with insert(s)
- cUPC and NSF approved



| PART# | DESCRIPTION |
|--------------|-----------------|
| 69728 | 1/2" ball valve |
| 69729 | 3/4" ball valve |
| 69730 | 1" ball valve |

EASYGRIP BALL VALVE IPS WITH DRAIN



- Designed to simplify pipe installation
- Allows users to connect pipe in seconds
- Instant pushfit connection for ease of use
- Certified to 200 PSI and 200°F (93°C)
- Fits OD controlled CPVC, PEX and copper pipe
- Body composed of solid DZR brass
- Supplied with insert(s)
- cUPC and NSF approved



| PART# | DESCRIPTION |
|--------------|----------------------------|
| 69739 | 1/2" ball valve with drain |

EASYGRIP CHECK VALVE



- Designed to simplify pipe installation
- Allows users to connect pipe in seconds
- Instant pushfit connection for ease of use
- Certified to 200 PSI and 200°F (93°C)
- Fits OD controlled CPVC, PEX and copper pipe
- Body composed of solid DZR brass
- Supplied with insert(s)
- cUPC approved



| PART# | DESCRIPTION |
|--------------|------------------|
| 69690 | 1/2" check valve |
| 69691 | 3/4" check valve |
| 69692 | 1" check valve |

EASYGRIP FLEXIBLE BRAIDED STAINLESS STEEL WATER HEATER SUPPLY CONNECTORS



- Used in residential and commercial applications
- Connects the hot and cold supply lines to the water heater
- Connectors are EPDM knitted with braided stainless steel
- Connectors are 3/4" FIP x 3/4"
- Can connect to copper(ASTM B88), PEX(ASTM F876) and CPVC(ASTM D2846) tubing (eliminates the need for additional transition fitting)
- cUPC approved



| PART# | DESCRIPTION |
|--------------|--------------------------------|
| 55588 | 3/4" FIP x 3/4" push fit x 18" |
| 55589 | 3/4" FIP x 3/4" push fit x 24" |

PEX ELBOWS - BRASS

PEX ELBOW



- PEX brass elbows make tight 90-degree connections for PEX tubing in supply and return mains

| PART# | DESCRIPTION |
|-------|-------------|
| 69500 | 1/2" |
| 69501 | 1/2" x 3/4" |
| 69502 | 3/4" |
| 69503 | 1" |

PEX DROP EAR ELBOW



- PEX drop ear brass elbow provides rigid 90-degree connections and the ability to secure PEX tubing

| PART# | DESCRIPTION |
|-------|---------------------|
| 69521 | 1/2" PEX x 1/2" FPT |

PEX SWEAT ELBOW



- PEX sweat elbows make tight 90-degree connections for PEX tubing in supply and return mains

| PART# | DESCRIPTION |
|-------|------------------------------|
| 69535 | 1/2" PEX x 1/2" male sweat |
| 69536 | 1/2" PEX x 1/2" female sweat |

PEX MALE THREAD ELBOW



- PEX male thread elbow provides rigid 90-degree connections and the ability to secure PEX tubing

| PART# | DESCRIPTION |
|-------|-----------------------------|
| 69537 | 1/2" PEX x 1/2" male thread |

FOR A WIDE SELECTION OF PEX TOOLS SEE PAGE L-1

PEX FITTINGS - BRASS

PEX TEE



- Tee Descriptions = (end) x (end) x (middle)
- PEX brass tees make diverting connections for PEX tubing in supply and return mains
- CSA approved



| PART# | END | END | MIDDLE |
|-------|------|------|--------|
| 69504 | 1/2" | 1/2" | 1/2" |
| 69505 | 1/2" | 1/2" | 3/4" |
| 69506 | 3/4" | 1/2" | 1/2" |
| 69507 | 3/4" | 1/2" | 3/4" |
| 69508 | 3/4" | 3/4" | 1/2" |
| 69509 | 3/4" | 3/4" | 3/4" |
| 69510 | 1" | 3/4" | 3/4" |
| 69511 | 1" | 1" | 3/4" |
| 69512 | 1" | 1" | 1" |

FITTING ADAPTERS 1/2" PEX X 3/8" COMPRESSION



part#12765



part#12766

- Chrome brass fittings
- Straight or angle
- One per hang tag bag package

| PART# | DESCRIPTION |
|-------|--------------------------------|
| 12765 | Straight, 1/2" PEX x 3/8 comp. |
| 12766 | Angle, 1/2" PEX x 3/8 comp. |

PEX COUPLING



- PEX Brass Coupling makes PEX-to-PEX connections for PEX tubing
- CSA approved



| PART# | DESCRIPTION |
|-------|-------------------------|
| 69513 | 1/2" x 1/2" PEX |
| 69514 | 1/2" x 3/4" PEX |
| 69515 | 3/4" x 3/4" PEX |
| 69516 | 1" x 1" PEX |
| 69517 | 1/2" PEX x 1/2" poly b. |
| 69518 | 3/4" PEX x 3/4" poly b. |

PEX FITTINGS - BRASS

PEX FEMALE ADAPTERS



- PEX to brass female NPT threaded adapter connects PEX tubing to male NPT threads
- CSA approved

PEX MALE ADAPTERS



- PEX to brass male NPT threaded adapter connects PEX tubing to male NPT threads
- CSA approved

| PART# | DESCRIPTION |
|-------|---------------------|
| 69531 | 1/2" PEX x 1/2" FPT |
| 69532 | 1/2" PEX x 3/4" FPT |
| 69533 | 3/4" PEX x 3/4" FPT |
| 69534 | 3/4" PEX x 1" FPT |

| PART# | DESCRIPTION |
|-------|---------------------|
| 69527 | 1/2" PEX x 1/2" MPT |
| 69528 | 1/2" PEX x 3/4" MPT |
| 69529 | 3/4" PEX x 3/4" MPT |
| 69530 | 1" PEX x 1" MPT |

PEX FEMALE SWEAT ADAPTERS



- PEX brass sweat adapter transitions PEX tubing to copper pipe
- CSA approved

PEX MALE SWEAT ADAPTERS



- PEX brass sweat adapter transitions PEX tubing to copper pipe
- CSA approved

| PART# | DESCRIPTION |
|-------|-------------------|
| 69524 | 1/2" x 1/2" sweat |
| 69525 | 3/4" x 3/4" sweat |
| 69526 | 1" x 1" sweat |

| PART# | DESCRIPTION |
|-------|-------------------|
| 69522 | 1/2" x 1/2" sweat |
| 69523 | 3/4" x 3/4" sweat |

PEX BEND SUPPORT



- Plastic bend supports provide rigid 90 degree bend for PEX tubing
- Made of reinforced nylon

| PART# | DESCRIPTION |
|-------|--------------|
| 1096 | 1/2" support |
| 1097 | 3/4" support |

PEX PLUG



- PEX brass plugs terminate the end of PEX tubing
- Plugs are installed for temporary or permanent usage
- CSA approved

| PART# | DESCRIPTION |
|-------|-------------|
| 69519 | 1/2" plug |
| 69520 | 3/4" plug |

PEX FITTINGS - BRASS

PEX SHOWER ELBOW



- Brass elbow for fiberglass / acrylic showers
- Securely mounts the shower arm or tub spout nipple to the shower
- Locknuts secure elbows to wall of shower
- 1-1/32" hole required in shower for use
- PEX connection in 1/2" or 3/4" PEX
- For IPS & sweat equivalent see **page E-7**

| PART# | DESCRIPTION |
|-------|-------------|
|-------|-------------|

| | |
|--------------|---------------------|
| 1196 | 1/2" PEX - packaged |
| 1197 | 3/4" PEX - packaged |
| 1196Q | 1/2" PEX - bulk |
| 1197Q | 3/4" PEX - bulk |

PEX CLAMP CTS 2H SUSPENSION



- Black Poly PEX clamps

| PART# | DESCRIPTION |
|-------|-------------|
|-------|-------------|

| | |
|--------------|--------|
| 69606 | 1/2" |
| 69607 | 3/4" |
| 69608 | 1" |
| 69609 | 1-1/4" |
| 69610 | 1-1/2" |
| 69611 | 2" |

PEX CLAMP SUSPENSION PIPE



- Black poly PEX clamps

| PART# | DESCRIPTION |
|-------|-------------|
|-------|-------------|

| | |
|--------------|--------|
| 69600 | 1/2" |
| 69601 | 3/4" |
| 69602 | 1" |
| 69603 | 1-1/4" |
| 69604 | 1-1/2" |
| 69605 | 2" |

PEX J CLAMP



- J clamps connect PEX tubing to wood surfaces

| PART# | DESCRIPTION |
|-------|-------------|
|-------|-------------|

| | |
|-------------|------|
| 1093 | 1/2" |
| 1094 | 3/4" |
| 1095 | 1" |

PEX FITTINGS - PLASTIC

PEX ELBOW



- Poly alloy plastic
- Certified to CSA B137.5
- Resistant to chlorine and scaling
- Off white in colour
- Poly bag packaged
- Warnock Hersey approved

| PART# | DESCRIPTION |
|-------|-------------------|
| 69802 | 3/4" x 1/2" elbow |
| 69803 | 1/2" elbow |
| 69804 | 3/4" elbow |

PEX PLUG



- Poly alloy plastic
- Certified to CSA B137.5
- Resistant to chlorine and scaling
- Off white in colour
- Poly bag packaged
- Warnock Hersey approved

| PART# | DESCRIPTION |
|-------|-------------|
| 69813 | 1/2" plug |
| 69814 | 3/4" plug |

PEX FEMALE PLASTIC ADAPTORS SWIVEL



- Poly Alloy Plastic
- Certified to CSA B137.5
- Resistant to chlorine and scaling
- Off white in colour
- Poly bag packaged
- Warnock Hersey approved

| PART# | DESCRIPTION |
|-------|--------------------------------|
| 69815 | 1/2" FPT swivel x 1/2" adaptor |
| 69816 | 3/4" FPT swivel x 3/4" adaptor |

PEX MALE PLASTIC ADAPTORS



- Poly Alloy Plastic
- Certified to CSA B137.5
- Resistant to chlorine and scaling
- Off white in colour
- Poly bag packaged
- Warnock Hersey approved

| PART# | DESCRIPTION |
|-------|-------------------------|
| 69809 | 1/2" MPT x 1/2" adaptor |
| 69810 | 3/4" MPT x 3/4" adaptor |
| 69811 | 3/4" MPT x 1/2" adaptor |
| 69812 | 1/2" MPT x 3/4" adaptor |

PEX FITTINGS

PEX TEE



- Poly alloy plastic
- Certified to CSA B137.5
- Resistant to chlorine as scaling
- Off white in colour
- Use same tools and brass fittings
- Poly bag packaged
- Warnock Hersey approved

PEX REDUCING TEE



- Poly alloy plastic
- Certified to CSA B137.5
- Resistant to chlorine and scaling
- Off white in colour
- Use same tools and brass fittings
- Poly bag packaged
- Warnock Hersey approved

PART# DESCRIPTION

| | |
|--------------|----------|
| 69800 | 1/2" tee |
| 69801 | 3/4" tee |

PART# DESCRIPTION

| | |
|--------------|------------------------|
| 69817 | 1/2" x 1/2" x 3/4" tee |
| 69818 | 3/4" x 1/2" x 1/2" tee |
| 69819 | 3/4" x 1/2" x 3/4" tee |
| 69820 | 3/4" x 3/4" x 1/2" tee |

PEX SWIVEL ELBOW



- Poly alloy plastic
- Certified to CSA B137.5
- Resistant to chlorine and scaling
- Off white in colour
- Use same tools and brass fittings
- Poly bag packaged
- Warnock Hersey approved

PEX COUPLING

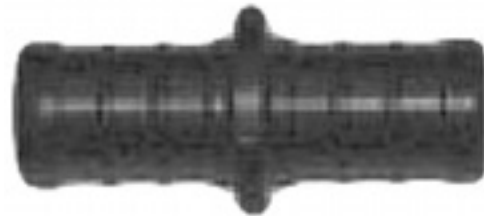

- Poly alloy plastic
- Certified to CSA B137.5
- Resistant to chlorine and scaling
- Off white in colour
- Use same tools and brass fittings
- Poly bag packaged
- Warnock Hersey approved

PART# DESCRIPTION

| | |
|--------------|------------------------------|
| 69805 | 1/2" FPT swivel x 1/2" elbow |
|--------------|------------------------------|

PART# DESCRIPTION

| | |
|--------------|----------------------|
| 69806 | 1/2" coupling |
| 69807 | 3/4" coupling |
| 69808 | 3/4" x 1/2" coupling |

PEX FITTINGS

OETIKER PEX CLINCH CLAMP



- LYNCAR offers the OETIKER clinch clamp
- Stainless steel - 530400 Grade
- Made in the U.S.A
- NSF approved



| PART# | DESCRIPTION |
|-------|-------------|
|-------|-------------|

| | |
|------|------|
| 1090 | 1/2" |
| 1089 | 5/8" |
| 1092 | 3/4" |
| 1098 | 1" |

PEX RING STAINLESS STEEL CLAMP



- LYNCAR "Clinch Clamp"
- Stainless steel
- Meets CSA B137.5 and ASTM F2098 standards
- Sold 100 per bag
- NSF approved



| PART# | DESCRIPTION |
|-------|-------------|
|-------|-------------|

| | |
|--------|--------------------------------|
| 109212 | 1/2" Stainless steel PEX clamp |
| 109234 | 3/4" Stainless steel PEX clamp |

PEX COPPER COMPRESSION RING



- Packs as 100 per bag for contractor use
- WARNOCK HERSEY approved to CSA B137.5



| PART# | DESCRIPTION |
|-------|-------------|
|-------|-------------|

| | |
|------|------|
| 7994 | 3/8" |
| 7991 | 1/2" |
| 7992 | 3/4" |
| 7993 | 1" |

PEX STUB OUT ELBOWS WITH STRAPS

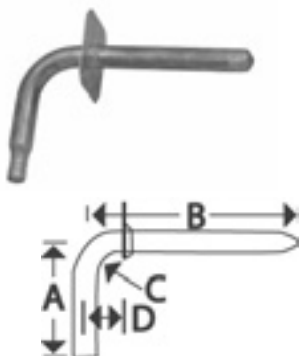

- Quality assurance
- 100% air-pressure tested
- Guaranteed leak-proof
- Perfect bending (no deformation) ensure better flow
- 1-1/4 radius bend for better fit inside 2 x 4 walls
- NSF, CSA and cUPC approved



| PART# | CONNECTION | A | B | C | D |
|-------|------------|--------|----|--------|--------|
| 69757 | 3/8" PEX | 3-1/2" | 6" | 1-1/4" | 1-3/4" |
| 69758 | 1/2" PEX | 3-1/2" | 6" | 1-1/4" | 1-3/4" |
| 69759 | 1/2" PEX | 3-1/2" | 8" | 1-1/4" | 1-3/4" |
| 69760 | 3/4" PEX | 4" | 8" | 1-3/4" | 2" |

PEX BALL VALVES

PEX 1/4 TURN STOP - ANGLE



- 1/4 turn stop valves for PEX
- Chrome plated
- CSA approved

| PART# | DESCRIPTION |
|-------------|--------------------------|
| 3346 | 1/2" PEX x 3/8" comp. |
| 3350 | 1/2" PEX x 1/4" OD comp. |

PEX 1/4 TURN STOP - STRAIGHT

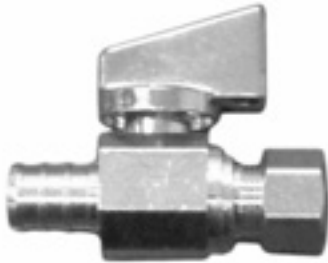

- 1/4 turn stop valves for PEX
- Straight or angle
- Chrome plated
- CSA approved

| PART# | DESCRIPTION |
|-------------|--------------------------|
| 3344 | 1/2" PEX x 3/8" comp. |
| 3343 | 1/2" PEX x 1/2" PEX |
| 3349 | 1/2" PEX x 1/4" OD comp. |

PEX STOP - ANGLE



- Compression stops for PEX
- Chrome plated
- CSA approved

| PART# | DESCRIPTION |
|--------------|-----------------------|
| 12662 | 1/2" PEX x 3/8" comp. |

PEX STOPS - STRAIGHT



- Compression stops for PEX
- Chrome plated
- CSA approved

| PART# | DESCRIPTION |
|--------------|-----------------------|
| 12666 | 1/2" PEX x 3/8" comp. |
| 12667 | 1/2" PEX x 1/2" PEX |

PEX BALL VALVES

PEX BALL VALVE



- LYNCAR'S ball valve with PEX ends
- Available in two sizes
- Brass body
- 600WOG

PEX BALL VALVE - WITH DRAIN



- LYNCAR'S ball valve with PEX ends
- Available in two sizes
- Brass body
- 600WOG
- With drain

| PART# | DESCRIPTION |
|-------|-------------|
| 3347 | 1/2" PEX |
| 3348 | 3/4" PEX |

| PART# | DESCRIPTION |
|-------|---------------------|
| 3347D | 1/2" PEX with drain |
| 3348D | 3/4" PEX with drain |

PEX BALL VALVE - BRASS MINI



- LYNCAR'S mini ball valve with PEX ends
- Available in three sizes
- Brass body chrome brass handle
- CSA approved

PEX BALL VALVE - BRASS MINI

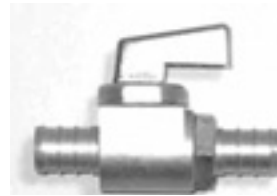

- LYNCAR'S mini ball valve with PEX ends
- Available in three sizes
- Brass body chrome brass handle
- CSA approved

| PART# | SIZE |
|-------|-----------------|
| 3345 | 1/2" PEX, angle |

| PART# | SIZE |
|-------|--------------------|
| 3340 | 3/8" PEX, straight |
| 3341 | 1/2" PEX, straight |
| 3342 | 3/4" PEX, straight |

SWEAT x PEX BALL VALVE



- LYNCAR'S ball valve with copper x PEX ends
- Available in two sizes
- Brass body
- 600WOG

PEX FROST FREE FAUCET WITH BUILT IN BREAKER



- Chrome Brass
- Frost Free with Breaker
- Self Draining
- 1/2" PEX
- CSA Approved

| PART# | DESCRIPTION |
|---------|-------------------|
| 3347CXP | 1/2" copper x PEX |
| 3348CXP | 3/4" copper x PEX |

| PART# | DESCRIPTION |
|---------|-------------|
| 806508P | 8" long |
| 806510P | 10" long |
| 806512P | 12" long |
| 806514P | 14" long |

PEX VALVES

SEDIMENT FAUCET WITH PEX



- 1/2" thread or PEX connection
- 3/4" MHT outlet
- NSF61 listed

| PART# | DESCRIPTION |
|-------|--------------------|
| 3389 | Boiler drain valve |

SILCOCK VALVE WITH PEX



- 1/2" PEX end connection
- 3/4" MHT
- With flange

| PART# | DESCRIPTION |
|-------|-------------------------|
| 3388 | Sillcock valve, PEX end |

SILCOCK VALVE WITH PEX 1/4 TURN



- 1/2" PEX end connection
- 3/4" MHT
- With flange
- cUPC approved

| PART# | DESCRIPTION |
|-------|----------------------------------|
| 3390 | Sillcock valve, PEX end 1/4 turn |

SECTION "H" CHEMICAL & SHOP SUPPLIES INDEX

| | | | |
|---------------------------------------|------|--------------------------------|------|
| Acid Brushes | H-5 | Hand Cleaner - LynCar | H-22 |
| Aluminum Antifreeze - RhoGard | H-24 | Knee Pads | H-13 |
| Aluminum Foil Tape | H-20 | Leak Detector | H-14 |
| Anaerobic Teflon Paste | H-8 | Leather Gloves | H-12 |
| Antifreeze Products | H-24 | Lubricating Oil | H-14 |
| Antifreeze Tester | H-23 | Lumber Crayon | H-23 |
| Bag - Zip Lock Plastic | H-23 | Magic Wrap | H-16 |
| Bin Boxes | H-23 | Markers - Pipe (Ball/Felt Tip) | H-22 |
| Boiler Brushes | H-2 | No Streak Glass Cleaner | H-2 |
| Brush - Utility (Chip & Oil) | H-4 | Oakum | H-17 |
| Brush In Can | H-18 | Oil | H-7 |
| Brush Rods & Handles | H-4 | Oil - Lubricating | H-14 |
| Brushes - Acid | H-5 | Packing- Graphite | H-17 |
| Brushes - Chimney | H-3 | Pipe Dope | H-6 |
| Brushes - Furnace & Boiler | H-2 | Pipe Markers (Ball/Felt Tip) | H-22 |
| Brushes - Utility | H-4 | Pipe Wrap Tape - PVC | H-19 |
| Brushes - Wood Handle | H-5 | Plastic Bags | H-23 |
| Brushes - Wood Handle Dope | H-4 | Plumber's Gloopzit - Goop | H-21 |
| Candle Wicking | H-17 | Plumbers Putty | H-18 |
| Caulking Compound Cord | H-15 | Power Fitting Brush | H-2 |
| Cement Compound | H-17 | ProBlue Thread Compound | H-7 |
| Chimney Brush Rods | H-4 | Propylene Glycol | H-24 |
| Chimney Brushes | H-3 | ProSeal Plus Teflon Paste | H-6 |
| Chip & Oil Brushes | H-4 | ProTowel Wipes | H-15 |
| Citrus Hand Cleaner | H-22 | Putty - Epoxy | H-21 |
| Cleaners - Shower | H-1 | Putty - Plumbers | H-18 |
| Cleaning Rags | H-11 | PVC Cement Wet/Dry | H-18 |
| Clog Remover | H-21 | Rags | H-11 |
| Cotton Gloves | H-12 | Rods & Handles for Chimney | H-4 |
| Coupling Grease | H-14 | S-39 Solder Flux | H-16 |
| Crayon - Lumber | H-23 | Shoe Covers | H-11 |
| Cutting Oil | H-7 | Silicone Sealants | H-16 |
| Descaler Solution for Tankless Heater | H-19 | Soapstone | H-21 |
| Disposable Gloves | H-9 | Solder Flux | H-16 |
| Dope Brush - Wood Handle | H-4 | Sprinkler Antifreeze | H-24 |
| Drain Cleaner | H-21 | Stem Grease | H-15 |
| Duct Tape | H-20 | Tankless Water Heater Cleaner | H-19 |
| Dust Mask | H-11 | Tape - Aluminum Foil | H-20 |
| Ear Plugs | H-11 | Tape - Duct | H-20 |
| Electrical Tape | H-20 | Tape - Electrical | H-20 |
| Epoxy Putty | H-21 | Tape - Filament | H-20 |
| Faucet Brite | H-1 | Tape - Pipe Wrap | H-19 |
| Filament Tape | H-20 | Tape - Teflon | H-8 |
| Filler - Crack | H-17 | Teflon - Packing | H-17 |
| Fitting Brush - Power | H-2 | Teflon Paste - Anaerobic | H-8 |
| Flow Clean Solution | H-19 | Teflon Paste - ProsealPlus | H-6 |
| Flux - Solder | H-18 | Teflon Tape | H-8 |
| Furnace Brushes | H-2 | Thread Compound - ProBlue | H-7 |
| Gas Leak Detector | H-14 | Threading Oil | H-7 |
| Glass Cleaner | H-1 | Twine - Nylon | H-23 |
| Gloves - Cotton | H-12 | Utility Brushes | H-4 |
| Gloves - Disposable | H-9 | Water Soluble Solder Flux | H-16 |
| Gloves - Latex / Nitride | H-10 | Wipes | H-15 |
| Gloves - Leather | H-12 | Wire Brushes | H-5 |
| Glue Wash Hand Cleaner | H-22 | X SEAL 3C AF Caulking Compound | H-15 |
| Graphite Packing | H-17 | | |

GEL GLOSS PRODUCTS

GEL-GLOSS

Retail Friendly Size



- Combines the most powerful non-abrasive cleaning agents with the most effective Carnauba waxes to produce the highest surface luster possible
- Removes surface scratches and oxidation while providing a long lasting protective finish. Excellent for sinks, basins, countertops, tubs, spas, RV's, boats, shower doors, stainless steel and porcelain
- Recommended for cleaning and maintenance of gel-coated surfaces

| PART# | SIZE FORMAT |
|--------------|---------------------|
| 31308 | 8 oz squeeze bottle |
| 3129 | 2 oz squeeze bottle |

GEL-GLOSS ORIGINAL FORMAT



- GEL GLOSS in 16 oz can or 12 oz aerosol

| PART# | SIZE FORMAT |
|-------------|---------------------|
| 3130 | 16 oz can |
| 3131 | 12 oz aerosol spray |

FAUCET BRITE



- For use on decorator bath fixtures
- Use with confidence on decorative bath fixtures, chrome and painted surfaces
- Faucet Brite cleans and seals, leaving behind a protective coating that resists tarnishing and improves water repellence
- This is a specially formulated utilizing polymer resin technology to enhance the beauty and protect the surface of coated fixtures

| PART # | SIZE FORMAT |
|--------------|---------------------|
| 3127 | 2 oz squeeze bottle |
| 31288 | 8 oz bottle |

GEL GLOSS DISPLAYS



- Great for impulse sales at your counter or store

| PART# | SIZE |
|--------------|--|
| 31310 | 2 oz squeeze bottle |
| | 18 pcs GEL GLOSS |
| | 9 pcs faucet brite polisher 9 pcs no streak glass cleaner |
| 31315 | 8 oz bottles |
| | 12 pcs GEL GLOSS |
| | 6 pcs faucet brite polisher |
| | 6 pcs no streak glass cleaner |

CHIMNEY BRUSHES

NO STREEK



- Amazing NO STREEK glass polish cleans and polishes in one convenient, easy application - keeping the promise that ordinary spray cleaners cannot
- Use NO STREEK for superior finishes on all glass, chrome and metal surfaces
- Fantastic on mirrors, too! a true professional grade polish, NO STREEK cleans cleaner and shines better - and works harder on hard water spots
- IT WORKS...EVEN IN DIRECT SUNLIGHT!

| PART # | DESCRIPTION |
|--------|---------------------|
| 3133 | 2 oz squeeze bottle |
| 3138 | 8 oz bottle |

POWER FITTING BRUSH



- Carbon steel - single spiral / single stem
- Power fitting brush with hex shaft. Hex locks into all standard and quick lock type chucks for easy change over

| PART # | DESCRIPTION |
|--------|-------------|
| 5134 | 1/2" size |
| 5135 | 3/4" size |
| 5136 | 1" size |

MASTER CLEAN - DOUBLE SPIRAL / DOUBLE STEM



- Double spiral tempered steel wire brush with heavy duty stem and 3/8" male pipe thread.
- Double spiral/double stem (4 wires)
- Brush bristles are twisted between four stem wires with two layers of bristles
- Each layer is perpendicular to the other with a single stem wire in each quadrant

| PART # | DESCRIPTION |
|--------|-------------|
| 43401 | Round - 8" |
| 43405 | Square - 8" |

**FIBRE FILLED FURNACE & BOILER BRUSHES
SINGLE SPIRAL / SINGLE STEM**



- Extra heavy fill, 6" long brush part with wooden handle.
- Single spiral / single stem (2 wires)
- Brush bristles are twisted between two stem wires with a single wire on each side

| PART # | DESCRIPTION |
|--------|---------------------|
| 43370 | 2" x 27" brush size |
| 43371 | 3" x 27" brush size |
| 43372 | 2" x 42" brush size |
| 43373 | 3" x 42" brush size |

CHIMNEY BRUSHES

PREMIUM BRUSH - SINGLE SPIRAL / DOUBLE STEM



- Single spiral polypropylene bristle brush with heavy duty stem and 3/8" male pipe thread.
- Single spiral/double stem (4 wires)
- Brush bristles are twisted between four stem wires with two stem wires on each side

| PART # | TYPE | SIZE |
|--------------|--------|------|
| 43391 | Round | 6" |
| 43392 | Round | 7" |
| 43393 | Round | 8" |
| 43394 | Square | 7" |
| 43395 | Square | 8" |

MASTER CLEAN - DOUBLE SPIRAL / DOUBLE STEM



- 4-1/2" long spring grade tempered wire brush part, 1/4" male pipe thread.
- Double spiral/double stem (4 wires)
- Brush bristles are twisted between four stem wires with two layers of bristles
- Each layer is perpendicular to the other with a single stem wire in each quadrant

| PART# | FLUE SIZE | BRUSH DIAMETER |
|--------------|-----------|----------------|
| 43306 | 1" | 3/4" |
| 43308 | 1-1/4" | 1" |
| 43312 | 1-1/2" | 1-1/4" |
| 43314 | 1-3/4" | 1-1/2" |
| 43316 | 2" | 1-3/4" |
| 43326 | 3" | 2-3/4" |
| 43336 | 4" | 3-3/4" |

PREMIUM BRUSH - SINGLE SPIRAL / DOUBLE STEM



- 4-1/2" long spring grade tempered wire brush part, 1/4" male pipe thread
- Other sizes are available, please call. Brushes are also available in stainless steel
- Single spiral/double stem (4 wires)
- Brush bristles are twisted between four stem wires with two stem wires on each side.

| PART # | FLUE SIZE | BRUSH DIAMETER |
|--------------|-----------|----------------|
| 43206 | 1" | 3/4" |
| 43208 | 1-1/4" | 1" |
| 43212 | 1-1/2" | 1-1/4" |
| 43214 | 1-3/4" | 1-1/2" |
| 43216 | 2" | 1-3/4" |
| 43226 | 3" | 2-3/4" |
| 43236 | 4" | 3-3/4" |

BRUSHES

BRUSH RODS & HANDLES

- For brushes we offer both handles and extensions in steel & fiberglass to complete your requirements



Loop Steel Handle



Steel Extension Rod



Fiberglass Rod

| PART# | FLUE SIZE | BRUSH DIAMETER |
|-------|-----------|--|
| 43375 | 48" | Loop steel handle - female 1/4" IPS end |
| 43376 | 72" | Loop steel handle - female 1/4" IPS End |
| 43377 | 48" | Steel extension rod - male x female 1/4" IPS |
| 43378 | 72" | Steel extension rod - male x female 1/4" IPS |
| 43384 | | T-handle 1/4" IPS |
| 43380 | 48" | Fiberglass rod - female 1/4" IPS |
| 43381 | 72" | Fiberglass rod - female 1/4" IPS |
| 43382 | 48" | Fiberglass rod - female 3/8" IPS |
| 43383 | 72" | Fiberglass rod - female 3/8" IPS |
| 43384 | | T-handle 1/4" IPS |
| 43385 | | T-handle 3/8" IPS |

BRUSH - UTILITY (CHIP & OIL)



- White chinese bristle, metal ferrule, plain sanded wood handle
- Low priced economy import.

| PART # | DIAMETER |
|--------|----------|
| 4645 | 1/2" |
| 4647 | 1" |
| 4649 | 2" |

DOPE BRUSH - WOOD HANDLE



- Select horsehair bristles secured tightly in metal ferrule, round sanded wood handle
-#7 brushes sold 36 pieces per box

| PART # | SIZE | LENGTH |
|--------|----------|----------|
| 4653 | # 7 wood | 5-13/16" |

BRUSHES

ACID BRUSH - NATURAL BRISTLE

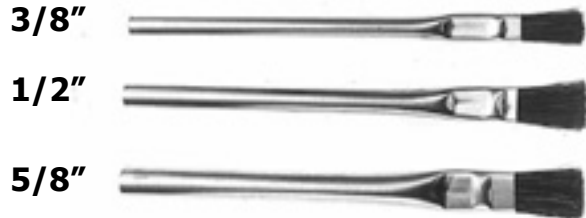

- Select horsehair bristles are pressed securely in tin handles.
 - #1, #2, #4 Brushes sold 144 pieces per box

| PART # | SIZE | BRISTLE WIDTH | HANDLE LENGTH |
|--------|------|---------------|---------------|
| 4650 | # 1 | 3/8" | 5-1/4" |
| 4651 | # 2 | 1/2" | 5-1/2" |
| 4652 | # 4 | 5/8" | 6-7/8" |

WIRE BRUSH - CURVED HANDLE



- 14" hardwood block filled with 3 Rows x 19
 - Tufts of tempered steel bristles

| PART # | DESCRIPTION |
|--------|----------------------------|
| 4480 | Wire brush - curved handle |

BRUSH - UTILITY



- 3 x 7 rows, 1/2" trim
 - 7" long plastic block with 1-1/2" long brush end

| PART # | DESCRIPTION |
|--------|----------------|
| 5137 | Steel bristles |
| 5138 | Brass bristles |

WIRE BRUSH - SHOE HANDLE



- 10" hardwood block filled with 4 Rows x 17
 - Tufts of tempered steel bristles

| PART # | DESCRIPTION |
|--------|--------------------------|
| 4482 | Wire brush - shoe handle |

PIPE DOPE



PROSEAL PLUS TEFLON PASTE



- Approved for BLAZEMASTER
- PSI: 0 - 10,000psi
- Temperature range: -50°F to +500°F
- Colour: off white
- Shelf life: infinite
- Material: Teflon filled, synthetic compound
- Resists:
 - Water
 - Steam
 - Air
- Not suitable for use with oxygen
- Anti-seizing, chemically inert, non-hardening, non-corrosive, non drying
- Lubricates, protects and seals threads and fittings of:
 - Stainless Steel
 - Nickel
 - Synthetic rubbers
 - Brass
 - Galvanized iron
 - Monel
 - Aluminum
 - Alloys
 - Coppers
 - Plastics

| PART # | DESCRIPTION | UNITS |
|-----------|--------------|-------|
| 506250PBT | 250ml BT can | 24 |
| 506500PBT | 500ml BT can | 12 |
| 506000P | 1 litre can | 12 |

THREADING OIL & THREADING COMPOUND

H

CHEMICAL & SHOP



PROBLUE THREAD COMPOUND

NONTOXIC  NUN-TOXIQUE

LYNCAR Products

ProBlue
Industrial 

**PIPE THREAD
COMPOUND**

“For a Positive Leakproof Seal”
“Pour un joint sûr et ultra-étanche”



- PROBLUE is a non teflon based pipe thread sealant that can be used on PVC, ABS & CPVC plastic pipe, and also metal pipe
- Lubricates during assembly! Non hardening
- ULC Approved

| PART # | SIZE | UNITS |
|---------------|--------------|-------|
| 509250 | 250ml BT can | 24 |
| 509500 | 500ml BT can | 12 |
| 509100 | 1 litre can | 12 |

THREADING OIL



LYNCAR Products

ProThread
Industrial

**Pipe Threading Oil
Huile A Fillage**

*Better Quality Threads
& Longer Die Life*



- LYNCAR'S pipe threading oil is NOT cutting oil
- It is formulated for threading pipe. Either hand threading or machine threading our formula will result in better quality threads and longer die life !

| PART # | SIZE | UNITS |
|----------------|----------------|-------|
| 506011 | 1 litre bottle | 12 |
| 506010 | 4 litre jug | 4 |
| 506015 | 20 litre pail | 1 |
| 5060205 | 205 litre drum | 1 |

CHEMICALS & SHOP SUPPLIES

TEFLON TAPE - WHITE



- Superior quality teflon tape

TEFLON TAPE - PINK



- Heavy duty tape
- Superior density & thickness

| PART# | DESCRIPTION | CASE |
|--------|-------------|------|
| 506065 | 1/2" x 480 | 100 |
| 506034 | 3/4" x 520 | 70 |
| 506080 | 1" x 520 | 50 |

| PART# | DESCRIPTION | CASE |
|--------|-------------|------|
| 506070 | 1/2" x 520 | 250 |
| 506072 | 3/4" x 520 | 70 |

TEFLON TAPE - YELLOW GAS LINE



- 1/2" x 260" yellow
- Heavy duty tape
- Superior density & thickness
- 100 rolls-per-box
- Specifically designed to seal threads in natural gas, propane, butane, kerosene and petroleum oil lines
- For use on threads not exceeding 1-1/2"
- CSA approved

| PART# | DESCRIPTION | CASE |
|--------|-------------|------|
| 506075 | 1/2" x 260 | 100 |

TEFLON TAPE - ORANGE



- Premium teflon tape in orange
- High density and extra thick
- For natural and LP gases
- CSA approved

| PART# | DESCRIPTION | CASE |
|--------|-------------|------|
| 506090 | 1/2" x 540 | 50 |
| 506095 | 1/2" x 1296 | 50 |

ANAEROBIC TEFLON PASTE - ALL PURPOSE



- This is a general purpose all use anaerobic teflon paste product
- Use in many different applications.
- Instant seal up to 100 PSI, full cure up to 10,000 PSI
- No drip consistency, can be applied directly to hot and oily pipe threads

| PART # | DESCRIPTION | CASE |
|--------|--------------|------|
| 501635 | 350ml BT can | 12 |
| 501675 | 750 BT can | 8 |

ANAEROBIC TEFLON PASTE - LOW STRENGTH



- This is a special formula anaerobic teflon paste used mainly for fire sprinkler head installation
- It will easily disassemble after setting, for repositioning and adjusting of wall mount sprinkler heads
- Will not break CPVC reducers or crack pipe

| PART# | DESCRIPTION | CASE |
|--------|--------------|------|
| 501735 | 350ml BT can | 12 |
| 501775 | 750 BT can | 8 |

DISPOSABLE GLOVES

LATEX DISPOSABLE GLOVES - INDUSTRIAL GRADE



- Premium quality
- Excellent resistance to a variety of chemicals
- First rate elasticity and flexibility
- Good touch sensitivity providing a strong grip
- 100 Per box, Sold by the box
- XL size

| PART# | DESCRIPTION |
|-------|--|
| 950 | Latex disposable gloves - industrial grade |

VINYL DISPOSABLE GLOVES - INDUSTRIAL GRADE



- Latex free
- Tan colour
- Made from premium quality vinyl
- Excellent resistance to a variety of chemicals
- Stretches more than conventional vinyl gloves
- 100 Per box, sold by the box

| PART# | DESCRIPTION |
|-------|--|
| 9552 | Vinyl disposable gloves - industrial grade |

NITRILE DISPOSABLE GLOVES



- Dark blue colour
- Premium medical quality
- Nitrile, 4mil thick
- 100/box, sold by the box

| PART# | DESCRIPTION |
|-------|----------------|
| 9596 | Nitrile gloves |

BLACK NITRILE EXAMINATION DISPOSABLE GLOVE



- Powder free, chlorinated, textured
- Resistant to oils, detergents and solvents
- Stronger and more tear and puncture resistant than vinyl or latex gloves
- 4 mil thick, 9-1/2" long, 100 pairs per box

| PART# | DESCRIPTION |
|-------|--------------|
| 9570 | Large |
| 9571 | XL |
| 9572 | XXL (90/box) |

CHEMICALS & SHOP SUPPLIES

NITRILE FOAM COATED NYLON GLOVES



- Foam Nitrile Coated Nylon Gloves
- Black on black
- Ideal for handling sensitive parts & materials
- Sold 12 per box

| PART# | DESCRIPTION |
|--------------|-----------------------|
| 9561 | Nitrile coated gloves |

LIGHT DUTY, NATURAL LATEX GLOVES - LINED



- 16 mil
- 100% cotton lined for added comfort
- Good strength for a longer lasting glove
- Excellent resistance to a variety of chemicals
- 12 pair per bag / 24 per carton

| PART# | DESCRIPTION |
|--------------|--|
| 9553 | Light duty, natural latex gloves - lined |

NITRILE GLOVES - UNLINED



- 15 mil
- Latex Free
- Excellent resistance to abrasion, cuts, snags, punctures, aging and gas.
- High level of flexibility and easy finger movement
- 12 pair per bag

| PART# | DESCRIPTION |
|--------------|--------------------------|
| 9554 | Nitrile gloves - unlined |

CHEMICALS & SHOP SUPPLIES

H

DUST MASK - DISPOSABLE



- Cone shaped mask
- Elastic strip
- 50 per box

| PART# | DESCRIPTION |
|-------|------------------------|
| EDM50 | Dust mask - disposable |

SHOE COVERS, DISPOSABLE



- Non-woven polypropylene shoe covers
- Textured bottom for skid resistance
- Elastic on top for easier on/off
- Extra pliable material for greater flexibility in movement
- 100 per bag, sold by the bag

| PART# | DESCRIPTION |
|-------|-------------------------|
| 9550 | Shoe covers, disposable |

CLEANING RAGS



- LYNCAR mixed cotton rags.
- Use in your shop, van

| PART# | SIZE |
|--------|-----------|
| 608506 | 25 LB bag |
| 608507 | 10 LB bag |

EAR PLUGS - DISPOSABLE



- Cylindrical earplugs are made from a higher tech, brand new premium PVC foam
- It generates lower inner ear pressure.
- Military approved for its lack of moisture susceptibility
- Slower "recovery time" allows for deeper insertion and a more secure fit
- Plugs are uncorded.
- NRR 29 noise reduction rating
- 200 pairs per box, packaged in poly bags

| PART# | DESCRIPTION |
|--------|------------------------|
| EAR100 | Ear plugs - disposable |

CHEMICAL & SHOP

GLOVES

LATEX COATED KNITTED GLOVE



- Comfortable
- Excellent wet or dry grip
- Blue colour latex coating
- 12 pairs per bag

SPLIT LEATHER GLOVES



- # 1 best seller
- Grey leather palm with 100% cotton back
- Reinforced finger tips and knuckle strap
- 2-1/2 safety cuff

| PART# | DESCRIPTION |
|-------|----------------------------|
| 9555 | Latex coated knitted glove |

| PART# | DESCRIPTION |
|-------|----------------------|
| 5232 | Split leather gloves |

COTTON GLOVES



- 8 oz. canvas cotton glove
- Chute cut with knit wrist,
- Can be washed and reused

GLOVES - DRIVER'S



- Rich grain cowhide face and back with cotton shirring
- Large ONLY

| PART# | DESCRIPTION |
|-------|---------------|
| 641 | Cotton gloves |

| PART# | DESCRIPTION |
|-------|-------------------|
| 1213 | Gloves - driver's |

GLOVES - PLASTIC DOT



- 8 oz. cotton glove
- Stronger grip with PVC dots
- Glove breathability pulls sweat away from hands for comfort

KNIT ANTI-SLIP GRIP GLOVES



- Black dot coating on seamless cotton knit
- Standard weight
- Unique PVC coating processes provide sure gripping ability and excellent abrasion resistance for gloves that are comfortably pliable and reduce hand, arm and back fatigue.

| PART# | DESCRIPTION |
|-------|----------------------|
| 5501 | Gloves - plastic dot |

| PART# | DESCRIPTION |
|-------|----------------------------|
| 640 | Knit anti-slip grip gloves |

LINED SPLIT LEATHER GLOVES



- Lined with 3M "Thinsulate Lining"
- Grey leather palm with 100% cotton back
- Reinforced finger tips and knuckle strap
- 2-1/2 safety cuff

JERSEY GLOVE



- Knit wrist jersey in seal brown 9oz. fabric
- Cold weather favourite!

| PART# | DESCRIPTION |
|-------|----------------------------|
| 5233 | Lined split leather gloves |

| PART# | DESCRIPTION |
|-------|--------------|
| 403 | Jersey glove |

KNEE PADS & SUPPORT

H

KNEE PAD - HEAVY DUTY



- Super lightweight comfort
- Single adjustable 1-1/2" wide velcro strap
- Thick, soft inner lining
- Blue colour

| PART# | DESCRIPTION |
|-------|-----------------------|
| 9223 | Knee pad - heavy duty |

KNEE PAD - TRADESMAN



- Super lightweight comfort
- Double adjustable straps
- Extra foam protection
- Thick, soft inner lining
- Blue colour

| PART# | DESCRIPTION |
|-------|----------------------|
| 9224 | Knee pad - tradesman |

KNEE PAD - BUILDERS



- Accordion top design helps secure the kneepad in position as you get up and down
- Straps are comfortable/easy to adjust
- Durable outer cover
- Upper strap eliminates debris from entering the top of the kneepad

| PART# | DESCRIPTION |
|-------|---------------------|
| 9220 | Knee pad - builders |

CHEMICAL & SHOP

CHEMICALS & SHOP SUPPLIES

GAS LEAK DETECTOR - BY LYNCAR



Formulated to locate gas leaks in pipe lines, valves, pressure vessels, cylinders, tanks, etc. After applying leak detector directly from container to exterior surface, large bubbles will appear if there is gas escaping.
May be used to find leaks of air, natural gas, refrigerants, CO2 and most other gases. This product is non-toxic, non-flammable and non-freezing to 10°F.

| PART# | DESCRIPTION |
|-------|------------------|
| 59082 | 1oz bottle |
| 59083 | 237ml dabber top |
| 59085 | 473ml spray top |

EASE - ON COUPLING GREASE



- LYNCAR'S EASE-ON grease, for mechanical couplings.
- 908 gram tubs and 12 per case
- NSF ANSI N5F61

| PART# | DESCRIPTION |
|--------|---------------------------|
| 506060 | EASE - ON coupling grease |

LUBRICATING OIL



- An all purpose oil for use on motors, bearings and wherever metal lubrication is desired.
- Contains rust and corrosion preventatives
- Not for use on internal combustion engines or extreme heat producing operations
- Packaged with a telescopic spout so oil can be applied in hard to reach places

| PART# | DESCRIPTION |
|-------|--------------|
| 59084 | 4 oz. bottle |

CHEMICALS & SHOP SUPPLIES

H

PROTOWEL - TOUGH WIPE



- A strong abrasive towel impregnated with hand cleaner
- Formulated to remove adhesives, sealants, spray paints, enamels, latex paint, grease tar, ink and much more
- Can be used to clean hands, tools, equipment, desk tops, etc.
- Size: 10" x 12-1/2"
- 70 count rolls

| PART# | DESCRIPTION | CASE |
|-------|-------------|------|
| 59080 | 70 wipes | 6 |

STEM LUBE HEAT PROOF GREASE



- Specially formulated for use on all metal faucets and valve stems carrying air, steam, and hot or cold water
- Also lubricates ballcocks, plungers, packings and washers
- Can be used on potable water since it is safe and nontoxic

| PART# | DESCRIPTION |
|-------|-----------------------------|
| 3155 | Stem lube heat proof grease |

**X SEAL 3C AF (ASBESTOS FREE)
COLD CAULKING COMPOUND CORD**



- Asbestos-free
- Sulphate resistant
- Ready for use - no mixing
- Quick and easy to apply
- Can be used in damp conditions
- Provides an immediate seal
- Withstands pressures in excess of 6.9 N/Mm² (1000 Lbf/In²)
- Accommodates vibration and limited expansion and deflection movement
- Resistant to biological degradation
- Cord eliminates wastage
- Product previously known as PC4

| PART# | DESCRIPTION |
|-------|----------------------------|
| 2895 | 2 m. length |
| 2896 | 3k tin, 14m. approximately |

CHEMICAL & SHOP

SILICONE SEALANTS

SILICONE SEALANT



- LYNCAR'S 100% Silicone, and kitchen and bath comes in 300ml tubes in white, clear, and grey. stays flexible, won't crack or peel, 40 year expected lifetime
- Adheres to most surfaces
- Kitchen & bath features a watertight & mildew resistance
- Siliconized is a lower cost product with a 25 year expected lifetime
- All Silicone products are in a 12 tube (300ml) display box

| PART# | DESCRIPTION | COLOUR |
|-------|----------------|--------|
| 39001 | Silicone | CLEAR |
| 39002 | Silicone | WHITE |
| 39003 | Silicone | GREY |
| 39301 | Kitchen & bath | CLEAR |
| 39302 | Kitchen & bath | WHITE |
| 39303 | Kitchen & bath | GREY |
| 39304 | Kitchen & bath | ALMOND |
| 39401 | Siliconized | CLEAR |
| 39402 | Siliconized | WHITE |

SILICONE TUBE



- Super soft
- Stainless
- Never hardens
- White colour

| PART# | SIZE | CASE |
|-------|---------------------|---------|
| 39222 | 162ml tube silicone | 12/case |

UNIVERSAL WATER SOLUBLE SOLDER FLUX



- LYNCAR'S "S-39" is a completely water soluble, flushable, self cleaning flux for soldering copper lines in plumbing.
- "S-39" is an acid free, lead free, liquid soldering flux, that is suitable on all types of tin solder (from 40/60 to lead free), copper, brass, polished chrome, steel, zinc, nickel, galvanized iron, silver, tin, lead and their alloys

| PART# | SIZE | CASE |
|--------|--------|------|
| 506057 | 80 ml | 16 |
| 506058 | 320 ml | 12 |

MAGIC WRAP



- Emergency repair kit on a roll
- 1" x 16' roll
- Stretches to 3 times its length
- Non adhesive
- Soft bonding
- Water & air tight
- Temperature resistant

| PART# | DESCRIPTION |
|-------|-------------|
| 59054 | Magic wrap |

CHEMICALS & SHOP SUPPLIES

H

CANDLE WICKING



- Seals bonnet nuts
- Lubricates stems
- Random length

| PART# | DESCRIPTION |
|-------|----------------|
| 2872 | Candle wicking |

TEFLON PACKING



- A round cord formable and flexible gasketing material made from pure 100% P.T.F.E. It is used for valve stem packing and flange gasketing applications
- Highly conformable will not seize, has excellent chemical resistance and operates from temperatures -400° F to +600° F
- Not intended for food contact applications

| PART# | SIZE |
|-------|-------------|
| 1886 | 3/32" x 10' |
| 1887 | 5/32" x 10' |

GRAPHITE PACKING



- 1/16" x 24" Length

| PART# | DESCRIPTION |
|-------|------------------|
| 2290 | Graphite packing |

OAKUM - CUT LENGTH



- Convenient, labour saving cut lengths
- Non-splitting
- Contains no tar
- Made to pack well, caulks tight
- Treated with a special compound so that it expands when wet
- Lead ladles, Lead pots, Joint runners and caulking tools are also available

| PART# | DESCRIPTION |
|-------|-------------|
| 2899 | 1lb bag |
| 2897 | 5lbs box |

SWIFT SET CEMENT



- Cement patching compound
- Sets in minutes
- For concrete & masonry repairs
- For floors, precast & drain rework
- For repairs up to 2" thick
- Clean up tools with water

| PART# | DESCRIPTION |
|-------|-------------|
| 2893 | 2kg tub |

PLUG TITE CEMENT



- Stops flow of water through breaks in concrete & masonry
- Works on basement walls, floor, pools etc.
- Fills cracks 3-5 minutes set-time
- Clean up tools with water

| PART# | DESCRIPTION |
|-------|-------------|
| 2894 | 2kg tub |

CHEMICAL & SHOP

CHEMICALS & SHOP SUPPLIES

PVC CEMENT WET/DRY



- One stop cement
- Low VOC
- All weather
- Fast set time 20 seconds
- NSF61, NSF14 approved
- Meets ASTM D2564

| PART# | DESCRIPTION | CASE |
|--------|--------------|------|
| 506059 | 237ml BT can | 24 |

SOLDER FLUX PASTE



- Self cleaning
- Noncorrosive
- Lead free
- Use on Copper, Iron, Steel
- Not recommended for Aluminum

| PART# | DESCRIPTION | CASE |
|-------|-------------|------|
| 59110 | 4oz jar | 24 |

WATER SOLUBLE PASTE FLUX



- AQUA PRO 2000
- Water soluble flux
- Non fuming and lead free
- Meets ASTM B813

| PART# | DESCRIPTION | CASE |
|-------|-------------|------|
| 59115 | 4oz | 24 |

PLUMBER'S PUTTY



- Does not harden
- Cream colour

| PART# | DESCRIPTION | CASE |
|-------|-------------|------|
| 59100 | 14oz | 24 |
| 59105 | 5lb tub | 6 |

BRUSH IN CAN



- LYNCAR offers the popular brush in can with either a metal OR plastic jug.
- Available in two sizes 500ml or 1 litre containers
- Our brush offers the "Click It" feature a natural bristle adjustable brush that is leak proof, and the handle adjusts in the cap.

| PART# | DESCRIPTION |
|-------|---------------------------------------|
| 78810 | Click it brush w/ 500 ml metal can |
| 78812 | Click it brush w/ 1 litre plastic can |
| 78814 | Click it brush w/ 500 ml plastic can |
| 4656 | "Click it" brush ONLY |

CHEMICALS & SHOP SUPPLIES

H

FLOW CLEAN DESCALER SOLUTION TANKLESS WATER HEATER CLEANER & KIT



- Cleaner for potable water systems
- Non corrosive, non toxic
- Biodegradable and zero VOC
- Dissolves water scale, lime, rust and other deposits
- In tankless water heaters, also in ice machines, boilers, chillers, exchangers etc.
- NSF approved

DESCALER KIT

- 350 GPH pump
- 2 pcs 60" rubber hoses
- 1 litre solution bucket with lid

| PART# | DESCRIPTION | CASE |
|-------|----------------------------|------|
| 15150 | 32oz (1 litre) plastic jug | 12 |
| 15151 | 4 litre jug | 6 |
| 15152 | Descaler kit | 1 |

PIPE WRAP TAPE - PVC



- LYNCAR all weather pipe protection tape is a pure physical barrier that is moisture proof, inert and non-conducting. Whether the need is to protect overhead piping in industrial applications, exposed pipe anywhere, or direct burial piping. This tape gives a completely uniform coating all around.
- Tough PVC plastic tape with special high tack adhesives formulated to resist corrosion
- Easy to apply by hand with no special tools or equipment
- Positive protection against abrasion and corrosive action for steel pipe, fittings and electrical conduit systems
- Corrosion protection for metal piping systems above and below ground
- Corrosion protection for fittings and joints on mill coated pipe
- Corrosion protection of electrical conduct and fittings
- Resists corrosive action by salt water, soil acids, alkalies and salts
- Prevents dielectric corrosion between buried steel pipe and soil minerals
- Resists the effects of outdoor weathering and sunlight exposure
- High abrasion resistance
- Highly conformable over a wide temperature range
- Excellent insulating properties
- Resists commonly encountered chemicals and chemical vapors
- Protects against fungus and bacteria

The type printed on the actual tape as shown below.

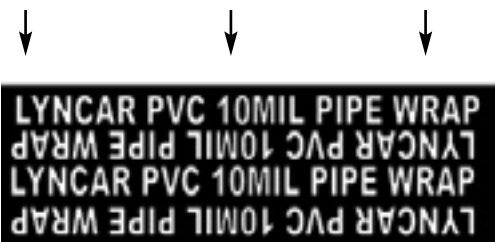

| PART# | WIDTH | MILL | LENGTH | CASE |
|-------|-------|------|--------|------|
| 9051 | 1" | 10 | 100' | 48 |
| 9052 | 2" | 10 | 100' | 24 |
| 9054 | 4" | 10 | 100' | 12 |

CHEMICAL & SHOP

TAPES

DUCT TAPE



- Contractor grade quality
- 48mm x 55m
- Each roll retail packaged
- 24 rolls per case

| PART# | DESCRIPTION |
|-------|-------------|
| 8518 | Duct Tape |

ELECTRICAL TAPE



- Contractor grade quality
- 3/4" x 60' Roll
- Each roll retail packaged, 10 rolls per sleeve
- CSA

| PART# | DESCRIPTION |
|-------|-----------------|
| 8520 | Electrical Tape |

ALUMINUM FOIL TAPE



- Contractor grade quality
- 48mm x 50m
- Each roll retail packaged
- 24 rolls per case

| PART# | DESCRIPTION |
|-------|--------------------|
| 8519 | Aluminum Foil Tape |

FILAMENT TAPE



- Fiberglass reinforced tape for general strapping and bundling applications.

| PART# | DESCRIPTION |
|-------|-------------|
| 8510 | 12mm x 55m |
| 8514 | 48mm x 55m |

CHEMICALS & SHOP SUPPLIES

H

GREEN BLASTER DRAIN OPENER



- Drain opener
- Dry granular drain opener for clearing grease, hair and other organic matter from drains.
- Will not harm Chrome, Polished Brass or Plastic. Safe for Septic tanks
- 454 grams
- Product only available in English at this time

| PART# | DESCRIPTION | CASE |
|--------------|-----------------------|------|
| 59005 | Professional strength | 24 |

PLUMBER'S GLOOZIT



- Secure or resecure towel bars that are loose: apply to the threads of stripped screws
- Patch leaks in plastic, copper, steel and cast iron pipes
- Attach ceramic soap dishes to tile - no screws needed!
- Repair garden hoses
- Repair leaks in gutter, down pipe and seams on eavestroughing
- Cement plastic pipe together
- Attach decorations to mirror, attach mirrors to any wall, whether tile, wood, cement or gyprock
- 90 mil tube

| PART# | DESCRIPTION |
|-------------|-------------------|
| 1711 | Plumber's gloozit |

EPOXY PUTTY, STIK-IT



- STIK-IT EPOXY PUTTY is a hand kneadable fast curing epoxy putty that mixes in one minute to provide permanent repairs to many surfaces including metals, wood, glass, concrete, ceramics and numerous plastics
- One hour after mixing, STIK-IT EPOXY PUTTY can be drilled, sawed, sanded, filed, tapped, machined or painted
- It comes in a handy "tootsie roll" form with the curing agent encapsulated in the contrasting colour base material
- Its remodeling clay-like consistency eliminates drips and runs, provides "no mess" application with no tools required for use
- STIK-IT EPOXY PUTTY is a general purpose epoxy putty.

| PART# | SIZE |
|--------------|-------|
| 59070 | 2 oz. |
| 59075 | 4 oz. |

SOAPSTONE



- Temporary marking of welding & cutting lines
- Made of natural soapstone
- 144 pcs per box
- Flat 1/2" x 3/16" x 5"

| PART# | DESCRIPTION |
|-------------|-------------|
| 5190 | Soapstone |

CHEMICAL & SHOP

CHEMICALS & SHOP SUPPLIES

GLUE WASH HAND CLEANER



- "GLUE-WASH" solvent cement hand cleaner lotion is a nontoxic hand cleaner that safely removes ABS and PVC plastic solvent cements from skin

| PART# | SIZE | CASE |
|--------|--------|------|
| 506055 | 118 ml | 24 |
| 506056 | 473 ml | 12 |

LYNCAR CITRUS HAND CLEANER



- LYNCAR citrus HC contains the superior power of pure natural citrus oils
- Fresh citrus scent from real lemons, limes, and oranges is pleasant while cleaning up, yet it vanishes quickly and does not linger
- Contains no artificial fragrances and is readily biodegradable, non-toxic and petroleum solvent free.
- Natural citrus oils make LYNCAR Citrus HC a TOUGH, hard working hand cleaner that performs and hates grime, yet treats your hands with the care they deserve.
- Conditions your skin to help prevent drying and cracking

| PART# | SIZE | CASE |
|-------|---------|------|
| 59001 | 473 ml | 12 |
| 59002 | 4 litre | 6 |
| 59003 | 118 ml | 24 |

PIPE MARKERS (BALL TYPE)



- LYNCAR'S paint markers are ideal for writing notes, job # or other information on pipe
- The ball point is a marker that liquid flows on to the point after pressing the top bubble
- Yellow & white stocked, other colours are available if requested

| PART# | COLOUR | CARTON |
|---------|--------|--------|
| 608520W | White | 12 |
| 608520Y | Yellow | 12 |

PIPE MARKERS (FELT TIP)



- LYNCAR'S paint markers are ideal for writing notes, job # or other information on pipe
- The fiber point is a marker that liquid flows on to the fiber tip after marker is shaken
- Available in packs of 12 yellow & white stocked, other colours are available if requested

| PART# | COLOUR | CARTON |
|---------|--------|--------|
| 608522W | White | 12 |
| 608522Y | Yellow | 12 |

PACKAGING & STORAGE PRODUCTS

CRAYON - WATERPROOF LUMBER



| PART# | DESCRIPTION |
|-------------|-------------|
| 5333 | 12 x yellow |
| 5334 | 12 x red |

BIN BOXES



- Corrugated bin boxes, no staples or tape needed
- Heavy duty boxes made from corrugated fiberboard, use them many times
- Fits standard 12" and 18" shelving units for storage of all your plumbing parts
- Many sizes available, call if we don't list your required size

| PART# | DEPTH | SIZE | HEIGHT |
|--------------|----------|------|--------|
| BB212 | 12" deep | 2" | 4-1/2" |
| BB412 | 12" deep | 4" | 4-1/2" |
| BB812 | 12" deep | 8" | 4-1/2" |
| BB218 | 18" deep | 2" | 4-1/2" |
| BB418 | 18" deep | 4" | 4-1/2" |
| BB818 | 18" deep | 8" | 4-1/2" |

BAG - ZIP LOCK PLASTIC



- LYNCAR can supply you with a wide selection of plastic bags for your inventory
- All bags are zip lock bags with a hanging hole and are 4 mil thick

| PART# | WIDTH | LENGTH |
|--------------|-------|--------|
| BAG01 | 5" | 8" |
| BAG04 | 4" | 6" |
| BAG05 | 6" | 9" |
| BAG21 | 4" | 12" |
| BAG34 | 3" | 4" |
| BAG35 | 3" | 5" |
| BAG66 | 6" | 6" |
| BAG69 | 6" | 9" |

TWINE - NYLON SEINE



- 275' of #18, 179 lb. test
- For plumb line, seine line, fishing line, chalk line, mason line and lead line
- To stop fraying when cut, apply flame to cut end (nylon melts)

| PART# | DESCRIPTION |
|-------------|---------------------|
| 4115 | Twine - nylon seine |

ANTIFREEZE TESTER



- LYNCAR'S antifreeze tester (refractometers) is high quality, impact resistant and comes in its own carrying case
- Provides accurate direct reading in both fahrenheit and centigrade of glycol coolants

| PART# | DESCRIPTION |
|---------------|-------------------|
| 996055 | Antifreeze tester |

HEAT TRANSFER FLUIDS

LYNCAR PG 95/5



- **LCPG 95/5** is a safe and odorless non-flammable premium heat transfer fluid with special corrosion inhibitors added. Contains 95% Propylene Glycol & 5% corrosion inhibitors (Dipotassium Hydrogen Phosphate and Inert Ingredients) Suitable for hydronic heating, and other process piping systems. Available in 4, 20 and 205 Litre containers.
- **ATTENTION**
Not for use with aluminum, galvanized or CPVC piping systems.

| PART# | SIZE |
|--------|----------------|
| 506032 | 4 litre jug |
| 506031 | 20 litre pail |
| 506030 | 205 litre drum |

LYNCAR PG PURE



- **LCPG Pure** is a safe and odorless non-flammable premium antifreeze fluid. Contains 100 % Propylene Glycol. Suitable for Fire Sprinkler Systems. Conforms to the NFPA 13, 2007 edition. Colourless, odorless, available in 4, 20 and 205 Litre containers.
- **ATTENTION**
Not for use with aluminum, galvanized or CPVC piping systems

| PART# | SIZE |
|--------|----------------|
| 506004 | 4 litre jug |
| 506020 | 20 litre pail |
| 506025 | 205 litre drum |

RHOGARD ALUMINUM ANTIFREEZE



- Burst protection to -100°F
- Environmentally friendly
- Non-hazardous
- Hydronic and solar system heat transfer fluid
- Freeze and corrosion protection, contains multi-metal corrosion inhibitors

| PART# | SIZE |
|--------|-----------|
| 506033 | 20kg pail |

LYNCAR GL PRE-MIXED ANTIFREEZE



- **LCGL48** is a safe and odourless non flammable premium premixed antifreeze fluid for fire sprinkler systems
- Contains Glycerine Antifreeze 48% by volumed conforms to the 2010 edition of NFPA. Available in 4,20 and 205 litre containers

| PART# | SIZE |
|----------|----------------|
| 50610448 | 4 litre jug |
| 50612048 | 20 litre pail |
| 50612548 | 205 litre drum |

LYNCAR PG PRE-MIXED ANTIFREEZE



- **LCPG38** is a safe and odourless non flammable premium premixed antifreeze fluid for fire sprinkler systems
- Contains Propylene Glycol 38% by volumed conforms to the 2010 edition of NFPA. Available in 4,20 and 205 litre containers

| PART# | SIZE |
|----------|----------------|
| 50600438 | 4 litre jug |
| 50602038 | 20 litre pail |
| 50602538 | 205 litre drum |

SECTION "J" SPECIAL TIES, PIPE LABELS & FIRE SUPPLY INDEX

| | | | |
|-----------------------------------|------|-----------------------------------|------|
| Access Doors - Fire Rated | J-22 | Flexible Couplings | J-1 |
| Access Doors - Metal | J-22 | Flow Switches - Potter | J-41 |
| Access Panel - ABS Plastic | J-23 | Fluidmaster - Access Panel | J-23 |
| Access Panel - ABS Snap Panel | J-23 | Foot Valve | J-7 |
| Access Panel - Fluidmaster | J-23 | Frost Free Faucet | J-9 |
| Access Panel - Metal | J-22 | Garden Hose Shutoff Valve | J-10 |
| Adapters - Hose to Pipe | J-20 | Gas Tape | J-35 |
| Aluminum Water Heater Pans | J-25 | Gaskets - Red Rubber | J-17 |
| Anchor Kit | J-35 | Gauges - Boiler | J-16 |
| Anode Rod - Water Heater | J-25 | Gauges - Pressure | J-15 |
| Arrestors - Water | J-19 | Gauges - Sprinkler | J-15 |
| Arrow Tape | J-35 | Gauges - Thermometer | J-16 |
| Ball Valves | J-11 | Head Guards - Sprinkler | J-40 |
| Barricade Tape | J-35 | Heads - Sprinkler Fire | J-37 |
| Boiler Gauges | J-16 | Hose Bibb Valve | J-7 |
| Boiler Plug | J-24 | Hose Bibb Valve Quarter Turn | J-8 |
| Boiler Drain Valve | J-7 | Hose Cap & Chain | J-10 |
| Boiler Drain Valve - Quarter Turn | J-8 | Hose Clamps | J-5 |
| Brass Plugs | J-28 | Hose Faucet Timer | J-9 |
| Brass Tags | J-35 | Hose to Pipe Adapters | J-20 |
| Cap - Hose | J-10 | Lawn Faucets | J-9 |
| Cast Iron Wall Plate | J-27 | Liquid Filled Gauges | J-15 |
| Chain - Sign Hanging | J-35 | Markers- Pipe Labels | J-29 |
| Clamp - Hose | J-5 | Metal Split Wall Plates | J-26 |
| Clamp - Repair | J-6 | MJ Couplings | J-4 |
| Clean Out Caps | J-5 | No-Hub Couplings | J-4 |
| Cleanout - Cover Plates | J-27 | Pigtail Siphon | J-14 |
| Cleanout Plugs - Brass | J-28 | Pipe Labels - On a Roll | J-33 |
| Coupling - Flexible | J-2 | Pipe Labels - Snap Plastic | J-34 |
| Coupling - Transition | J-2 | Pipe Labels - Stickers | J-29 |
| Coupling - Socket | J-4 | Plastic Access Doors | J-23 |
| Cover Plates | J-27 | Plastic Split Wall Plate | J-26 |
| Dielectric Unions | J-27 | Plastic Water Heater Pans | J-25 |
| Doors- Access | J-22 | Poppet Relief Valve | J-18 |
| Drain & Sewer Cap | J-27 | Potter Products | J-41 |
| Drain & Trap Connectors | J-3 | Pressure Gauges | J-15 |
| Elbow - PVC | J-3 | Pressure Switches - Potter | J-41 |
| Electric Cords- Replacement | J-24 | PROSEAL Transition Couplings | J-2 |
| Element Gaskets | J-24 | Quarter Turn Valves- Low Pressure | J-8 |
| Element Wrench | J-24 | Radiator Air Valves | J-14 |
| Elements for Water Heater | J-25 | Radiator Handle | J-14 |
| Escutcheons - Split | J-26 | Red Rubber Gaskets | J-17 |
| Escutcheons - Sprinkler | J-39 | Repair Clamp- TrueHugger | J-6 |
| Expansion Tanks | J-18 | Repair Clamps | J-6 |
| F&C Plates Plastic & Metal | J-26 | Repair Elbow PVC | J-3 |
| Faucet - Frost Free | J-9 | Repair PVC Tee | J-3 |
| Faucet - Sediment | J-7 | Repair Trap PVC | J-4 |
| Fire Sprinkler Products | J-37 | Rubber Flexible Couplings | J-1 |
| Flange Repair Kit | J-17 | Sediment Faucet | J-7 |

SECTION "J" SPECIAL TIES, PIPE LABELS & FIRE SUPPLY INDEX

| | | | |
|--------------------------------|------|--|--|
| Sediment Faucet - Quarter Turn | J-8 | | |
| Shut-off Valves | J-12 | | |
| Shut-off Valve Garden | J-10 | | |
| Sign Hanging Chain | J-35 | | |
| Socket Couplings | J-4 | | |
| Sprinkler Escutcheons | J-39 | | |
| Sprinkler Guards | J-40 | | |
| Sprinkler Heads | J-37 | | |
| Sump Pump Check Valve | J-18 | | |
| Swing Check Valve | J-7 | | |
| Switch - Flow Potter | J-41 | | |
| Switch - Pressure Potter | J-41 | | |
| Tags - Brass | J-35 | | |
| Tanks - Expansion | J-18 | | |
| Tape - Arrow | J-35 | | |
| Tape - Barricade | J-35 | | |
| Tape - Natural Gas | J-35 | | |
| Tee - PVC | J-3 | | |
| Test Caps | J-5 | | |
| Thermocouples - Copper | J-24 | | |
| Thermometer Gauges | J-16 | | |
| Transition Couplings | J-2 | | |
| Trap - PVC Repair | J-4 | | |
| TrueFlex Couplings | J-1 | | |
| Union - Dielectric | J-27 | | |
| Vacuum Breaker | J-9 | | |
| Valve - Air Radiator | J-14 | | |
| Valve - Ball | J-11 | | |
| Valve - Boiler Drain | J-7 | | |
| Valve - Check Sump Pump | J-18 | | |
| Valve - Check Sump Silencer | J-18 | | |
| Valve - Foot | J-7 | | |
| Valve - Hose Bibb | J-7 | | |
| Valve - Petcock | J-12 | | |
| Valve - Relief | J-18 | | |
| Valve - Shut off Brass | J-12 | | |
| Valve - Spring Bottom | J-12 | | |
| Valve - Swing Check | J-7 | | |
| Wall Plate - Cast Iron | J-27 | | |
| Wall Plates | J-26 | | |
| Washer - Cone Filter | J-10 | | |
| Washer - Garden Hose | J-10 | | |
| Water Hammer Arrestors | J-19 | | |
| Water Heater Anode Rod | J-25 | | |
| Water Heater Element Gaskets | J-24 | | |
| Water Heater Elements | J-25 | | |
| Water Heater Pan - Aluminum | J-25 | | |
| Water Heater Pan - Plastic | J-25 | | |
| Wrench - Element | J-24 | | |

FLEXIBLE RUBBER PIPE COUPLINGS

J



- LYNCAR'S TRUEFLEX Couplings
- Connects cast iron, plastic, steel, copper and tubular piping
- Manufactured to ASTM 1173 and CSA B602 Standards
- No glue, welding or soldering
- Compensate for misaligned pipe
- Tight seal every time
- Sizes from 1-1/4" to 8"
- cUPC approved

| | | |
|----------------------------|--------------------------|-------------------------|
| CI = Cast Iron Pipe | PL = Plastic Pipe | CLAY = Clay Pipe |
|----------------------------|--------------------------|-------------------------|

| PART# | DESCRIPTION | APPLICATION | CARTON QTY |
|---------------|-------------------------------|-------------------------------|------------|
| FC1250 | TrueFLEX cUPC 1-1/4" | 1-1/4" CI, PL x 1-1/4" CI, PL | 100 |
| FC1514 | TrueFLEX cUPC 1-1/2" x 1-1/4" | 1-1/2" CI, PL x 1-1/4" CI, PL | 100 |
| FC1515 | TrueFLEX cUPC 1-1/2" | 1-1/2" CI, PL x 1-1/2" CI, PL | 100 |
| FC2000 | TrueFLEX cUPC 2" | 2" CI, PL x 2" CI, PL | 100 |
| FC2150 | TrueFLEX cUPC 2" x 1-1/2" | 2" CI, PL x 1-1/2" CI, PL | 100 |
| FC3000 | TrueFLEX cUPC 3" | 3" CI, PL x 3" CI, PL | 80 |
| FC3020 | TrueFLEX cUPC 3" x 2" | 3" CI, PL x 2" CI, PL | 80 |
| FC3150 | TrueFLEX cUPC 3" x 1-1/2" | 3" CI, PL x 1-1/2" CI, PL | 80 |
| FC4000 | TrueFLEX cUPC 4" | 4" CI, PL x 4" CI, PL | 60 |
| FC4015 | TrueFLEX cUPC 4" x 1-1/2" | 4" CI, PL x 1-1/2" CI, PL | 60 |
| FC4020 | TrueFLEX cUPC 4" x 2" | 4" CI, PL x 2" CI, PL | 60 |
| FC4030 | TrueFLEX cUPC 4" x 3" | 4" CI, PL x 3" CI, PL | 60 |
| FC5000 | TrueFLEX cUPC 5" | 4" CLAY x 4" CLAY | 30 |
| FC5030 | TrueFLEX cUPC 5" x 3" | 4" CLAY x 3" CI, PL | 30 |
| FC5040 | TrueFLEX cUPC 5" x 4" | 4" CLAY x 4" CI, PL | 30 |
| FC6000 | TrueFLEX cUPC 6" | 6" CI, PL x 6" CI, PL | 20 |
| FC6030 | TrueFLEX cUPC 6" x 3" | 6" CI, PL x 3" CI, PL | 20 |
| FC6040 | TrueFLEX cUPC 6" x 4" | 6" CI, PL x 4" CI, PL | 20 |
| FC6050 | TrueFLEX cUPC 6" x 5" | 6" CI, PL x 4" CLAY | 20 |
| FC8000 | TrueFLEX cUPC 8" | 8" CI, PL x 8" CI, PL | 10 |
| FC8040 | TrueFLEX cUPC 8" x 4" | 8" CI, PL x 4" CI, PL | 10 |
| FC8060 | TrueFLEX cUPC 8" x 6" | 8" CI, PL x 6" CI, PL | 10 |

SPECIALTIES

PROSEAL TRANSITION COUPLINGS



- LYNCAR'S PROSEAL transition couplings
- Creates rigid pipe connections
- Connects cast iron, plastic, steel, copper and tubular
- Each clamp is marked with size and use
- Meets ASTM C1460-2008 and CSA B602-05
- cUPC approved

CAST IRON, PLASTIC OR STEEL TO TUBULAR

| PART# | DESCRIPTION |
|---------|---|
| PC02150 | 1-1/2" CI, PL. or ST. to 1-1/2" tubular |
| PC02215 | 2" CI, PL. or ST. to 1-1/2" tubular |
| PC02155 | 1-1/2" tubular to 1-1/2" tubular |

COPPER TO TUBULAR

| PART# | DESCRIPTION |
|---------|---------------------------------|
| PC10150 | 1-1/2" copper to 1-1/2" tubular |
| PC10215 | 2" copper to 1-1/2" tubular |

CAST IRON, PLASTIC STEEL OR STEEL TO COPPER

| PART# | DESCRIPTION |
|----------|--|
| PC011125 | 1-1/2" CI, PL. or ST. to 1-1/4" copper or 1" PL. |
| PC01150 | 1-1/2" CI, PL. or ST. to 1-1/2" copper or 1 1/4" PL. |
| PC012125 | 2" CI, PL. or ST. to 1-1/4" copper or 1" PL. |
| PC01215 | 2" CI, PL. or ST. to 1-1/2" copper or 1 1/4" PL. |
| PC0122 | 2" CI, PL. or ST. to 2" copper |
| PC01315 | 3" CI to 1-1/2" copper or 1-1/4" PL. |
| PC0132 | 3" CI to 2" copper |
| PC0133 | 3" CI to 3" copper |
| PC0143 | 4" CI to 3" copper |
| PC0144 | 4" CI to 4" copper |

CAST IRON TO PLASTIC STEEL OR EXTRA HEAVY CAST IRON

| PART# | DESCRIPTION |
|---------|--|
| PC00150 | 1-1/2" CI, PL. or ST. to 1-1/2" CI, PL. or ST. |
| PC0022 | 2" CI, PL. or ST. to 2" CI, PL. or ST. |
| PC00215 | 2" CI, PL. or ST. to 1-1/2" CI, PL. or ST. |
| PC0033 | 3" CI to 3" PL, ST, or XH CI. |
| PC0043 | 4" CI to 3" PL, ST, or XH CI. |
| PC0044 | 4" CI to 4" PL, ST, or XH CI. |

CAST IRON TO CAST IRON, PLASTIC OR STEEL

| PART# | DESCRIPTION |
|---------|---------------------------|
| PC04320 | 3" CI to 2" CI, PL or ST. |
| PC04420 | 4" CI to 3" CI, PL or ST. |
| PC04430 | 4" CI to 3" CI |

COPPER TO COPPER

| PART# | DESCRIPTION |
|---------|--|
| PC03150 | 1-1/2" copper to 1-1/2" copper or 1-1/4" PL. |
| PC0322 | 2" copper to 2" copper |
| PC03215 | 2" copper to 1-1/2" copper or 1-1/4" PL. |
| PC0333 | 3" copper to 3" copper |

DRAIN & TUBULAR REPAIR CONNECTORS

DRAIN & TRAP CONNECTORS



- 1 per bag packaged
- Grey in colour
- Stainless Steel clamps
- For drains & tubular application

| PART# | DESCRIPTION |
|----------------|--|
| FC150DT | 1-1/4" or 1-1/2" tubular traps to all 1-1/4" - 1-1/2" drain piping |
| FC215DT | 1-1/4" or 1-1/2" tubular traps to all 1-1/4" or 2" drain piping (not copper) |

DRAIN & TRAP CONNECTORS



- 1 per bag packaged
- Grey in colour
- Stainless steel clamps
- For drains & tubular application

| PART# | DESCRIPTION |
|----------------|------------------------------------|
| FC150TC | 1-1/4" or 1-1/2" drain piping |
| FC100PC | 1" plastic - 1-1/4" plastic/copper |

DRAIN & TRAP CONNECTORS



- Fits 1-1/2" or 2" standpipes
- 1 per bag packaged
- Grey in colour
- Stainless steel clamps
- For drains, tubular and washing machine hose application

| PART# | DESCRIPTION |
|--------------|--|
| FCHG1 | 2" or 1-1/2" standpipe to 1" through 1-7/16" washer hose |

EASY TEE



- Make 90 degree connections easily
- Flexible PVC material
- Ideal replacement or repair fittings
- Stainless steel hose clamp
- cUPC approved



| PART# | DESCRIPTION |
|---------------|---------------------|
| FCY150 | Easy PVC tee 1-1/2" |
| FCY200 | Easy PVC tee 2" |
| FCY300 | Easy PVC tee 3" |
| FCY400 | Easy PVC tee 4" |

EASY ELBOW



- Make 90 degree connections easily
- Flexible PVC material
- Ideal replacement or repair fittings
- Stainless steel hose clamp
- cUPC approved



| PART# | DESCRIPTION |
|---------------|-----------------------|
| FCE150 | Easy PVC elbow 1-1/2" |
| FCE200 | Easy PVC elbow 2" |
| FCE300 | Easy PVC elbow 3" |
| FCE400 | Easy PVC elbow 4" |

SPECIALTIES

NO-HUB COUPLING / MJ COUPLING

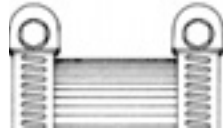

Size 1-1/2" Thru 4"

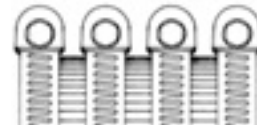

Size 5", 6" & 8"

- Clamp & shield all AISI 300 series stainless steel, no-hub gasket is neoprene
- CSA & ULC approved **CAN / ULC-S102 approval for "Surface Burning Characteristics of No Hub Coupling"** This is in addition to our CSA listing.

| PART# | SIZE |
|-------|-----------------|
| 64102 | 1-1/2" x 2" |
| 64103 | 2" x 3" |
| 64105 | 3" x 4" |
| 64106 | 1-1/2" x 1-1/2" |
| 64107 | 2" x 2" |
| 64108 | 3" x 3" |
| 64109 | 4" x 4" |
| 64110 | 5" x 5" |
| 64111 | 6" x 6" |
| 64112 | 8" x 8" |

SPECIALTIES

TRUE-FLEX SOCKET COUPLINGS



- LYNCAR'S TRUE-FLEX plastic to socket couplings
- Repair or alter plastic pipe joints. Fits over plastic pipe & fittings
- Hose clamp connections
- Up to 4"

| PART# | IPS |
|---------|----------------------------------|
| FC59150 | Socket to pipe coupling 1-1/2" |
| FC59220 | Socket to pipe coupling 2" |
| FC59330 | Socket to pipe coupling 3" |
| FC59440 | Socket to pipe coupling 4" |
| FC60150 | Socket to socket coupling 1-1/2" |
| FC60220 | Socket to socket coupling 2" |
| FC60330 | Socket to socket coupling 3" |
| FC60440 | Socket to socket coupling 4" |

TUBULAR REPAIR TRAP



- PVC repair trap for 1-1/4" or 1-1/2" drains
- Easy to repair and replace plastic or metal traps
- Simply clamp on

| PART# | DESCRIPTION |
|---------|----------------|
| FC150FT | PVC drain trap |

SPECIALTIES

NO-HUB TORQUE WRENCH



- Measures torque when turned in a clockwise direction & ratchets when turned counterclockwise
- When the brand screw is tightened to the correct torque, the wrench ratchets so the handle will continue to turn but the drive socket will not
- Chrome vanadium socket for 5/16" Hex Head Screw
- 6" Long, Torques to 60 inch lbs. with retractable reversing lever

PART# DESCRIPTION

7020 No-hub torque wrench

HOSE CLAMPS



- Highest grade 1/2" bandwidth
- 100% stainless steel, 5/16" Hex head screw
- Highly corrosion resistant for marine or underground use
- 63K series, 300 series stainless steel band and housing, with a 302 grade stainless steel, slotted hex head screw
- All stainless steel marine or underground

| PART# | BEST FITS | HOSE ID | OD SIZE RANGE | PART# | BEST FITS | HOSE ID | OD SIZE RANGE |
|--------------|-----------|---------|-----------------|--------------|-----------|---------|-----------------|
| 63006 | 3/8" | | 7/16"-25/32" | 63044 | 2-3/4" | | 2-51/6"-3-1/4" |
| 63008 | 3/8" | | 1/2"-29/32" | 63048 | 3" | | 2-9/16"-3-1/2" |
| 63010 | 5/8" | | 9/16"-1-1/16" | 63052 | 3-1/4" | | 2-13/16"-3-3/4" |
| 63012 | 3/4" | | 1-1/16"-1-1/4" | 63056 | 3-1/2" | | 3-1/6"-4" |
| 63016 | 1" | | 13/16"-1-1/2" | 63064 | 4" | | 3-9/16"-4-1/2" |
| 63020 | 1-1/4" | | 13/16"-1-3/4" | 63072 | 4-1/4" | | 4-1/8"-5" |
| 63024 | 1-1/2" | | 1-1/16"-2" | 63080 | 4-1/2" | | 4-5/8"-5-1/2" |
| 63028 | 1-3/4" | | 1-5/16"-2-1/4" | 63088 | 5" | | 5-1/8"-6" |
| 63032 | 2" | | 1-9/16"-2-1/2" | 63096 | 5-1/2" | | 5-5/8"-6-1/2" |
| 63036 | 2-1/4" | | 1-13/16"-2-3/4" | 63104 | 6" | | 6-1/8"-7" |
| 63040 | 2-1/2" | | 2-1/16"-3" | | | | |

MINIATURE HOSE CLAMP



- 37K SERIES 3/8" bandwidth
- 1/4" Hex head screw
- Marine grade, 100% stainless steel
- Screw - 305 stainless , band 300 series stainless, housing 300 series stainless

Part# BAND WIDTH SIZE RANGE

| | | |
|--------------|-------|--------------|
| 37004 | 5/16" | 7/32"-5/8" |
| 37006 | 3/8" | 7/16"-25/32" |
| 37008 | 3/8" | 1/2"-29/32" |
| 37010 | 1/2" | 1/2"-1" |

TEST CAP & CLEAN OUT

**HIGHEST GRADE
100% STAINLESS
STEEL
1/4" HEX HEAD
SCREW**



- Fits plastic and hubless cast iron DWV pipe
- Made from high quality rubber with a stainless steel clamp
- Rubber has cross rib for extra strength and inside knurling grips pipe



PART # SIZE

| | |
|-------------|--------|
| 4417 | 1-1/2" |
| 4418 | 2" |
| 4419 | 3" |
| 4422 | 4" |
| 4840 | 5" |
| 4841 | 6" |

STAINLESS STEEL REPAIR CLAMPS

ONE BOLT TYPE 3" LENGTH



- Stainless steel body with malleable iron lugs, neoprene gasket, carriage bolt & nuts

| PART# | IPS |
|-------|--------|
| 2660 | 1/2" |
| 2661 | 3/4" |
| 2662 | 1" |
| 2663 | 1-1/4" |
| 2664 | 1-1/2" |
| 2665 | 2" |
| 2666 | 2-1/2" |
| 2667 | 3" |
| 2669 | 4" |

TWO BOLT TYPE 6" LENGTH



- Stainless steel body with malleable iron lugs, neoprene gasket, carriage bolt & nuts

| PART# | IPS |
|-------|--------|
| 2674 | 1/2" |
| 2675 | 3/4" |
| 2676 | 1" |
| 2677 | 1-1/4" |
| 2678 | 1-1/2" |
| 2679 | 2" |
| 2680 | 2-1/2" |
| 2681 | 3" |
| 2683 | 4" |

HINGE TYPE-ECONOMICAL



- Plated steel, supplied with gasket that provides temporary repairs for split pipe

| PART# | IPS |
|-------|--------|
| 1680 | 1/2" |
| 1681 | 3/4" |
| 1682 | 1" |
| 1683 | 1-1/4" |
| 1684 | 1-1/2" |
| 1685 | 2" |

LYNCAR'S TRUEHUGGER REPAIR CLAMPS

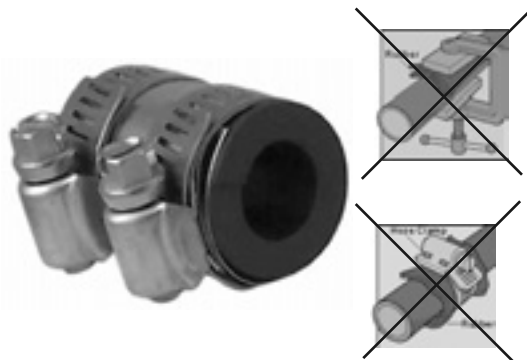

- Professional temporary repairs for split pipe, TrueHUGGER is a reuseable repair clamp
 - Similar to a MJ Coupling, split rubber core easily wraps around damaged pipe
 - Open to allow wrap around pipe
 - Twin stainless gear clamps and stainless steel backer housing with split neoprene rubber gasket

| PART# | IPS |
|-------|--------|
| 2700 | 1/2" |
| 2701 | 3/4" |
| 2702 | 1" |
| 2703 | 1-1/4" |
| 2704 | 1-1/2" |
| 2705 | 2" |

SPECIALTIES

PLUMBING VALVES

SWING CHECK VALVE - IPS



- Brass swing check valve
- 200 WOG
- IPS threads

| PART# | DESCRIPTION |
|-------|-------------|
| 81012 | 1/2" |
| 81034 | 3/4" |
| 81100 | 1" |

VALVE - SWING CHECK CXC



- Brass swing check valve
- 200 WOG
- Sweat ends

| PART# | DESCRIPTION |
|-------|-------------|
| 82012 | 1/2" |
| 82034 | 3/4" |

SEDIMENT FAUCET



- Brass sediment faucet male hose outlet
- CSA approved

FOR PEX EQUIVILANT SEE PAGE G-14

| PART# | DESCRIPTION |
|--------|-------------------|
| 89012 | 1/2", red handle |
| 89012B | 1/2", blue handle |
| 89034 | 3/4", red handle |

BOILER DRAIN VALVE



- Brass boiler drain valve
- IPS threads
- CSA approved

FOR PEX EQUIVILANT SEE PAGE G-14

| PART# | DESCRIPTION |
|-------|-------------|
| 90112 | 1/2" |
| 90034 | 3/4" |

FOOT VALVE



- Chrome brass foot valve

| PART# | DESCRIPTION |
|--------|-------------|
| 804012 | 1/2" |
| 804034 | 3/4" |
| 804100 | 1" |
| 804114 | 1-1/4" |
| 804115 | 1-1/2" |
| 804200 | 2" |

VALVE - HOSE BIBB



- Brass body
- Male IPS threads
- 3/4" garden hose outlet

| PART# | DESCRIPTION |
|-------|-------------|
| 92012 | 1/2" |
| 92034 | 3/4" |

PLUMBING VALVES - QUARTER TURN

HOSE BIBB / BOILER DRAIN Q/TURN VALVE



- 1/4 turn brass valve
- Red handle
- Male hose outlet
- CSA approved

| PART# | DESCRIPTION |
|--------------|------------------------------------|
| 97012 | 1/2" male or 1/2" C x C x 3/4" MHT |
| 97034 | 3/4" male x 3/4" MHT |

SEDIMENT FAUCET VALVE, Q/TURN



- 1/4 turn brass valve
- Red handle
- Male hose outlet
- cUPC approved

| PART# | DESCRIPTION |
|---------------|---|
| 98012 | 1/2" male or 1/2" C x C x 3/4" MHT, red handle |
| 98012B | 1/2" male or 1/2" C x C x 3/4" MHT, blue handle |
| 98034 | 3/4" male x 3/4" MHT, red handle |

FOR PEX EQUIVILANT SEE PAGE G-14

BOILER DRAIN HOSE BIBB VALVE Q/TURN



- 1/4 turn brass valve
- Red handle
- Male hose outlet
- CSA approved

| PART# | DESCRIPTION |
|--------------|----------------------|
| 99012 | 1/2" male x 3/4" MHT |
| 99034 | 3/4" male x 3/4" MHT |

SPECIALTIES

SPECIALTIES

HOSE FAUCET TIMER



- Orbit 2-hour hose faucet controller, easy to install to any outdoor hose faucet
- Battery-operated (three AA batteries Not Included; 18 VAC, 60 Hz) automatic water controller & valve combination
- Standard 3/4" and 3/4" BSP (international) hose thread connections
- Water-resistant design
- Manual on feature for quick temporary watering
- High quality diaphragm valve
- Flexible timer settings for the water to come on every: 2 hours, 4 hours, 8 hours, 12 hours, daily, every second day, every third day, every fourth day or once a week

PART# DESCRIPTION

91600 Hose faucet timer

VACUUM BREAKER



- Brass vacuum breaker
- 3/4 FHT x 3/4 MHT
- Vandal proof breakoff screw
- Box packed
- CSA approved



PART# DESCRIPTION

2139 Vacuum breaker

FROST FREE FAUCET



- Chrome brass
- 1/2" IPS
- CSA approved



PART# SIZE

806008 8"
806010 10"
806012 12"
806014 14"

SPECIALTIES

FAUCET - FROST FREE W/ BUILT IN VACUUM BREAKER



- Chrome body and tube
- Garden hose outlet
- Built in breaker, self draining
- Complete with plastic insert
- 1/2" MPT or 1/2" PEX ends
- CSA approved



PART# PEX PART# SIZE

806508 **806508P** 8"
806510 **806510P** 10"
806512 **806512P** 12"
806514 **806514P** 14"

SPECIALTIES

WASHER - GARDEN HOSE



- Fits 3/4" FHT

| PART# | DESCRIPTION |
|-------|----------------------|
| 2224 | Washer - garden hose |

WASHER - CONE FILTER



- Fits 3/4" FHT

| PART# | DESCRIPTION |
|-------|--------------------|
| 2244 | Washer cone filter |

HOSE CAP



- Brass
- Light duty
- With gasket

| PART# | DESCRIPTION |
|-------|-------------|
| 2152 | Hose cap |

BRASS HEX HOSE CAP & CHAIN



- 3/4 hose thread
- Hose cap-hex, brass
- Heavy duty
- With chain
- With gasket

| PART# | DESCRIPTION |
|-------|------------------------|
| 2154 | Hex hose cap and chain |

GARDEN HOSE SHUTOFF VALVE



- Plastic, positive ball shutoff
- 3/4" MHT x 3/4" FHT

| PART# | DESCRIPTION |
|-------|-------------------|
| 2157 | Straight shut off |
| 2158 | Wye shut off |

SHUT OFF BRASS, WYE



- 3/4" MHT x 3/4" MHT x 3/4" FHT
- With shut offs
- Brass

| PART# | DESCRIPTION |
|-------|------------------------|
| 2160 | Brass wye with shutoff |

PLUMBING BALL VALVES



BALL VALVE - FULL PORT IPS



- Premium quality valve
- Full port, brass body, teflon seat 600WOG
- IPS threads
- CSA, UL approved

| PART# | DESCRIPTION | PART# | DESCRIPTION |
|--------|-------------|--------|-------------|
| 806912 | 1/2" | 806914 | 1-1/4" |
| 806934 | 3/4" | 806915 | 1-1/2" |
| 806910 | 1" | 806920 | 2" |

VALVE - BALL 600 WOG FULL PORT CxC



- Premium quality valve
- Full port
- Brass body, teflon seat, 600 WOG
- Sweat ends
- CSA approved

| PART# | DESCRIPTION | PART# | DESCRIPTION |
|--------|-------------|---------|--|
| 807712 | 1/2" | 3347CXP | 1/2" copper x PEX see page G-13 |
| 807734 | 3/4" | 3347CXP | 3/4" copper x PEX see page G-13 |
| 807710 | 1" | | |

BALL VALVE - CxC W/ DRAIN



- Good quality utility valve
- Full port, sweat ends
- Brass body, teflon seat, 600 WOG

| PART# | SIZE | PART# | DESCRIPTION |
|--------|------|-------|----------------------------------|
| 806712 | 1/2" | 69739 | 1/2" PUSHFIT see page G-4 |
| 806734 | 3/4" | 3347D | 1/2" PEX see page G-13 |
| 806710 | 1" | 3348D | 3/4" PEX see page G-13 |

BALL VALVE - BARB x SWEAT



- Premium quality valve
- Barb x sweat
- 600 WOG body

| PART# | DESCRIPTION | PART# | DESCRIPTION |
|--------|-------------------------------|-------|----------------------------------|
| 806612 | 1/2" barb x sweat | 3348 | 3/4" PEX see page G-13 |
| 806634 | 3/4" barb x sweat | 69728 | 1/2" PUSHFIT see page G-4 |
| 806610 | 1" barb x sweat | 69729 | 3/4" PUSHFIT see page G-3 |
| 3347 | 1/2" PEX see page G-13 | 69730 | 1" PUSHFIT see page G-4 |

FOR PEX EQUIVILANT SEE PAGE G-13

PLUMBING VALVES & SHUT-OFF VALVES

J

LOCKING BALL VALVE FOR GAS



- Full Port
- 600 WOG
- Lockable lever handle
- CAN 3.16 approved
- FM, cUL, CSA approved



| PART# | SIZE |
|-------|------|
|-------|------|

| | |
|---------------|--------|
| 807812 | 1/2" |
| 807834 | 3/4" |
| 807810 | 1" |
| 807814 | 1-1/4" |
| 807815 | 1-1/2" |
| 807820 | 2" |

VALVE - BALL COMPRESSION



- Compression Connections
- Brass Body, Teflon Seat, 600 WOG, Full port
- Side Drain

| PART# | SIZE |
|-------|------|
|-------|------|

| | |
|---------------|------|
| 806812 | 1/2" |
| 806834 | 3/4" |
| 806810 | 1" |

VALVE - FEMALE x MALE PIPE



Do not use with liquified petroleum, natural gas, oxygen or similar explosive or combustible medium.

| PART# | FPT | MPT |
|-------|-----|-----|
|-------|-----|-----|

| | | |
|-------------|------|------|
| 7900 | 1/8" | 1/8" |
| 7901 | 1/4" | 1/4" |
| 7902 | 3/8" | 3/8" |

VALVE - MALE x MALE PIPE



Do not use with liquified petroleum, natural gas, oxygen or similar explosive or combustible medium.

| PART# | MPT | MPT |
|-------|-----|-----|
|-------|-----|-----|

| | | |
|-------------|------|------|
| 7903 | 1/8" | 1/8" |
| 7904 | 1/4" | 1/4" |
| 7905 | 3/8" | 3/8" |

VALVE - FEMALE x FEMALE PIPE



Do not use with liquified petroleum, natural gas, oxygen or similar explosive or combustible medium.

| PART# | FPT | FPT |
|-------|-----|-----|
|-------|-----|-----|

| | | |
|-------------|------|------|
| 7906 | 1/8" | 1/8" |
| 7907 | 1/4" | 1/4" |
| 7908 | 3/8" | 3/8" |

SPECIALTIES

SHUT OFF VALVES

VALVE - COMPRESSION



Do not use with liquified petroleum, natural gas, oxygen or similar explosive or combustible medium

| PART# | MPT |
|-------|------|
| 7910 | 1/8" |
| 7914 | 1/4" |
| 7916 | 3/8" |
| 7918 | 1/2" |
| 7919 | 1/2" |

VALVE - T-HANDLE DRAIN



Do not use with liquified petroleum, natural gas, oxygen or similar explosive or combustible medium.

| PART# | MPT |
|-------|------|
| 7947 | 1/8" |
| 7948 | 1/4" |
| 7949 | 3/8" |

COMPRESSION - 74 SERIES x MIP ANGLE VALVE



| PART# | DESCRIPTION |
|---------|-------------|
| 7-74542 | 1/4" x 1/8" |

SPECIALTIES

COMPRESSION - 75 SERIES x MIP VALVE



| PART# | DESCRIPTION |
|---------|-------------|
| 7-75042 | 1/4" x 1/8" |

COMPRESSION - 78 SERIES NEEDLE VALVE



| PART# | DESCRIPTION |
|--------|-------------|
| 7-7834 | 1/4" |
| 7-7836 | 1/8" |

SPECIALTIES

RADIATOR AIR VALVE WHEEL KEY



- Wood handle threaded
- Plated body
- 24 pcs per box

| PART# | DESCRIPTION |
|--------------|---------------------|
| 607 | Valve complete |
| 608 | Handle only |
| 605LK | Radiator Valve only |

RADIATOR AIR VALVE COIN VENT STYLE



| PART# | DESCRIPTION |
|------------|----------------|
| 605 | Valve complete |
| 606 | Handle only |

RADIATOR HANDLE 4 IN 1



- 4 in one handle sockets
- Fits 4 stem sizes
- One per bag

| PART# | DESCRIPTION |
|-------------|-------------------------|
| 4951 | 4 in one handle sockets |

PIGTAIL SIPHONS

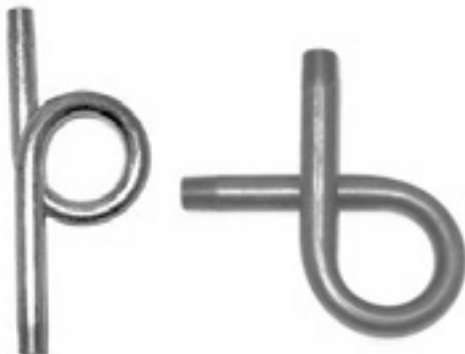

- 1/4" IPS steel
- Complies with ASTM B-53
- 600 PSI 750°F

| PART# | DESCRIPTION |
|-------------|-------------|
| 1459 | Straight |
| 1460 | Angle |

SPECIALTIES

GAUGE - LIQUID FILLED PRESSURE



- For use where gauge is exposed to corrosion, vibration, pulsation or metal fatigue such as pumps, compressors, hydraulic equipment and machine tools.
- Dual scale dial (KPA and PSI)
- 2-1/2" face in various pressure ranges
- 4" Face - 0 to 300 PSI
- 1/4" bottom mount brass connection

| PART# | TYPE | PSI | PART# | TYPE | PSI |
|-------------|------------------|--------|---------------|--------------|--------|
| 1772 | 2-1/2" dial face | 0-30# | 1773-4 | 4" dial face | 0-60# |
| 1773 | 2-1/2" dial face | 0-60# | 1774-4 | 4" dial face | 0-100# |
| 1774 | 2-1/2" dial face | 0-100# | 1776-4 | 4" dial face | 0-200# |
| 1776 | 2-1/2" dial face | 0-200# | 1777-4 | 4" dial face | 0-300# |
| 1777 | 2-1/2" dial face | 0-300# | 1779-4 | 4" dial face | 0-600# |

GAUGE - PRESSURE



- Dual scale dial (KPA & PSI)
- Steel case
- 1/4" MPT brass connection
- Plastic face
- 2-1/2" & 4" face sizes
- 1/4" bottom mount brass connection

| PART# | TYPE | PSI | PART# | TYPE | PSI |
|-------------|------------------|------|-------------|--------------|------|
| 1739 | 2-1/2" dial face | 30# | 1764 | 4" dial face | 60# |
| 1740 | 2-1/2" dial face | 60# | 1765 | 4" dial face | 100# |
| 1741 | 2-1/2" dial face | 100# | 1766 | 4" dial face | 160# |
| 1742 | 2-1/2" dial face | 160# | 1767 | 4" dial face | 200# |
| 1743 | 2-1/2" dial face | 200# | 1768 | 4" dial face | 300# |
| 1744 | 2-1/2" dial face | 300# | | | |

GAUGE - COMPOUND & VACUUM



- 2-1/2" diameter
- 1/4" MPT brass connection
- Steel case
- 1/4" bottom mount brass connection

| PART# | DESCRIPTION |
|-------------|-------------|
| 1422 | 30" vacuum |

GAUGE - FIRE PROTECTION SPRINKLER



- 3-1/2" diameter
- 1/4" MPT brass connection
- 1/4" bottom mount brass connection
- FM approved
- UL and ULC listed

| PART# | SYSTEM | PSI |
|---------------|--------|--------|
| 307600 | Wet | 0-300# |
| 307605 | Dry | 0-250# |
| 307601 | Combo | 0-300# |

FOR PLUMBING TEST GAUGES SEE PAGE L-18

GAUGES

BOILER GAUGES PRESSURE



- Specially constructed for use on hot water heater boilers
- Gives accurate indication of temperature and pressure
- Dual scale: 40° - 260° F, 20° - 120° C
- 2-3/4" diameter
- 1/2" MPT brass connection
- Steel case
- Glass face

| PART# | PSI | TEMP | CONNECTION & ELEMENT LENGTH |
|-------------|-------|------------|-----------------------------|
| 1451 | 0-50# | 60° - 260° | 2-3/4" bottom mount |
| 1452 | 0-50# | 60° - 260° | 2-3/4" back mount |

BOILER GAUGES TEMPERATURE



- Specially constructed for use on hot water heater boilers
- Gives accurate indication of temperature and pressure
- Dual scale: 60° - 320° F, 16° - 160°C, 2-3/4" diameter
- 1/4" MPT Brass connection
- Centre backmount
- Polycarbonate face

| PART# | PSI | TEMP | CONNECTION & ELEMENT LENGTH |
|----------------|-------|------------|-----------------------------|
| 1435 | 0-75# | 60° - 320° | 2-1/2" |
| 1437 | 0-75# | 60° - 320° | 3-1/2" |
| 1435BTM | 0-75# | 60° - 320° | 2-1/2" bottom mount |

THERMOMETER - DIAL TYPE



- Economical, back mount
- Dual scale: 40°-250°F, 0-120°C, accuracy to 1°, 5° Increments, 2-1/2" face
- Brass wells, recalibration feature,
- Choice of adapters
- Thermometer can be removed from adapter for easy installation

| PART# | DESCRIPTION |
|--------------|----------------------------|
| 1449 | 1/2" MPT CBM connection |
| 1449C | MPT CBM well only |
| 1450 | 3/4" CWT Solder connection |
| 1450W | CWT Solder well only |

THERMOMETER - HOT WATER



- Dual scale: 40°-280°F, 0°-130°C
- 1/2" Brass MPT connection

| PART# | STYLE |
|-------------|----------|
| 1444 | Angle |
| 1445 | Straight |

SPECIALTIES

THERMOMETER - DIAL TYPE



- Dial type
- Back mount
- Dual scale: 32°-250°F, 0°-120°C
- 3-1/2" diameter
- 1/2" MPT brass connection
- 2-1/2" brass element (beyond MPT)
- Corrosion resistant steel case

| PART# | DESCRIPTION |
|-------------|-------------------------|
| 1455 | 1/2" MPT CBM connection |

RED RUBBER GASKETS



- LYNCAR's red rubber gaskets and rolls
- All gaskets are packaged in 10's, wrapped and labeled
- Choose either ring or full face types
- We also offer square gaskets or rolls if you or your customer prefers to make your own

| FULL-FACE PART# | RING PART# | SIZE |
|-----------------|--------------|--------|
| 80201 | 80200 | 2" |
| 80213 | 80212 | 2-1/2" |
| 80301 | 80300 | 3" |
| 80401 | 80400 | 4" |
| 80601 | 80600 | 6" |
| 80801 | 80800 | 8" |

RED RUBBER SHEET



PART# 12551



PART# 12550

- 1/8" rubber sheet to make your own gasket

| PART# | DESCRIPTION |
|--------------|--|
| 12550 | Make a gasket sheet 6" x 6" x 1/8" |
| 12551 | Roll of red rubber 3 ft x 15 ft x 1/8" |

FLANGE REPAIR KIT



- All kits come with two ring gaskets, bolts and nuts
- Packaged, ready to install

| PART# | RING GASKET | SIZE OF BOLTS |
|---------------|-------------|-----------------------|
| 80201K | Kit 2" | 5/8" x 2-1/2" x 4 pcs |
| 80301K | Kit 3" | 5/8" x 2-3/4" x 4 pcs |
| 80401K | Kit 4" | 5/8" x 3" x 8 pcs |
| 80601K | Kit 6" | 3/4" x 3-1/2" x 8 pcs |

SPECIALTIES

POTABLE WATER & HYDRONIC EXPANSION TANKS



- Welded Steel construction
- Rugged flexible diaphragm
- Pre-charged at 12 PSIG
- Compact design saves energy and space
- Glycol compatible
- Maximum working pressure: 150 PSIG
- Ideal for peak use systems such as car washes, processing plants, hotels/motels, commercial laundries Pressure relief valves relieve excess pressure in cold water storage tanks and water supply lines

| PART# | DESCRIPTION |
|---------------|---------------------------|
| 80902A | Potable water 2.0 gallon |
| 80905A | Potable water 4.4 gallon |
| 80913A | Potable water 10.3 gallon |

PRESSURE RELIEF VALVE



- Bronze pressure only relief valves for supply lines and cold water storage tanks
- 50 to 160 PSIG
- 125 PSIG standard set pressure
- Adjustable by-pass relief valve available
- Protects equipment by allowing excess volume to be discharged to storage tank or back to the source

| PART# | DESCRIPTION |
|---------------|-------------|
| 80530 | 1/2" |
| 80530A | 3/4" |

SUMP PUMP CHECK VALVE



- ABS material, rubber coupling ends with stainless steel clamps
- Fast and easy installation
- Eliminates backflow

| PART# | DESCRIPTION |
|--------------|-------------|
| 29114 | 1-1/2" |
| 29112 | 2" |

SILENCER SUMP PUMP CHECK VALVE



- ABS material, rubber coupling ends with stainless steel clamps
- A silencer check valve eliminates hammering noises with pump cycling
- Vertical or horizontal

| PART# | DESCRIPTION |
|--------------|-------------|
| 29121 | 1-1/2" |
| 29122 | 2" |

SPECIALTIES

LYNCAR'S TRUEARRESTOR WATER HAMMER ARRESTOR

J

1/2" MIP



- Stops banging and thumping in water lines
- Can be installed at any angle
- "AA" size
- Carded for display
- cUPC approved
- ASSE 1010 approved



MALE SWEAT



- Stops banging and thumping in water lines
- Can be installed at any angle
- "AA" size
- Carded for display
- cUPC approved
- ASSE 1010 approved



| PART# | DESCRIPTION |
|----------------|-------------|
| 8030001 | 1/2" MIP |

| PART# | DESCRIPTION |
|----------------|-----------------|
| 8030002 | 1/2" male sweat |
| 8030003 | 3/4" male sweat |

PEX TEE



- Stops banging and thumping in water lines
- Can be installed at any angle
- "AA" size
- Carded for display
- cUPC approved
- ASSE 1010 approved



SJ TEE



- Stops banging and thumping in water lines
- Can be installed at any angle
- "AA" size
- Carded for display
- cUPC approved
- ASSE 1010 approved



| PART# | DESCRIPTION |
|----------------|--------------|
| 8030007 | 1/2" PEX tee |

| PART# | DESCRIPTION |
|----------------|-------------|
| 8030013 | 1/2" OD |

OD FEMALE COMP X OD COMP



- Stops banging and thumping in water lines
- Can be installed at any place
- "AA" size
- Carded for display
- cUPC approved
- ASSE 1010 approved



TEE



- Stops banging and thumping in water lines
- Can be installed at any place
- "AA" size
- Carded for display
- cUPC approved
- ASSE 1010 approved



| PART# | DESCRIPTION |
|----------------|------------------------------------|
| 8030014 | 3/8" OD female comp x 3/8 OD comp. |

| PART# | DESCRIPTION |
|----------------|-------------------------|
| 8030009 | 3/8" OD compression tee |
| 8030010 | 1/2" OD compression tee |

PEX, STRAIGHT



- Stops banging and thumping in water lines
- Can be installed at any place
- "AA" size
- Carded for display
- cUPC approved
- ASSE 1010 approved



LAUNDRY MINI-RESTER



- Stops banging and thumping in water lines
- Can be installed at any angle
- "AA" size
- Carded for display
- cUPC approved
- ASSE 1010 approved



| PART# | DESCRIPTION |
|----------------|-------------|
| 8030016 | 1/2" PEX |

| PART# | DESCRIPTION |
|----------------|----------------------------|
| 8030012 | 3/4" MHT x 3/4" swivel FHT |

SPECIALTIES

BRASS HOSE TO PIPE ADAPTERS

EVAPORATIVE COOLER ADAPTER



| | |
|-------------|------------------------------------|
| MHT | = MALE HOSE THREADS |
| MPT | = MALE PIPE THREADS |
| FHT | = FEMALE HOSE THREADS |
| FGHT | = FEMALE GARDEN HOSE THREAD |
| FPT | = FEMALE PIPE THREADS |

| PART# | MPT | FPT | FPT SIDE TAP |
|----------------|------------|------------|---------------------|
| 7-3098 | 1/2" | 1/2" | 1/8" |
| 7-30912 | 3/4" | 3/4" | 1/8" |

HOSE WYE



ADAPTER MALE HOSE - MALE PIPE



Tapped 1/2" FPT inside 3/4" MPT.

| PART# | MHT | MHT | FHT |
|--------------|------------|------------|------------|
| 2156 | 3/4" | 3/4" | 3/4" |

| PART# | MHT | MPT |
|--------------|------------|------------|
| 2140 | 3/4" | 3/4" |

ADAPTER MALE HOSE - MALE PIPE



The 1/2" copper connection is inside the 1/2" MPT.

FEMALE SWIVEL ADAPTER



| PART# | MHT | MPT | FEMALE COPPER SWEAT |
|--------------|------------|------------|----------------------------|
| 2143 | 3/4" | 1/2" | 1/2" |

| PART# | FHT SWIVEL | FPT |
|--------------|-------------------|------------|
| 2141 | 3/4" | 1/2" |
| 2142 | 3/4" | 3/4" |

ADAPTER FEMALE HOSE - MALE PIPE



Tapped 1/2" FPT inside 3/4" MPT

ADAPTER FEMALE HOSE - FEMALE PIPE



| PART# | FHT | MPT | FIP |
|--------------|------------|------------|------------|
| 2150 | 3/4" | 3/4" | 1/2" |

| PART# | FHT | FPT |
|--------------|------------|------------|
| 2147 | 3/4" | 1/2" |
| 2148 | 3/4" | 3/4" |

BRASS HOSE TO PIPE ADAPTERS

ADAPTER FEMALE HOSE - MALE PIPE



- The 1/2" copper connection is inside the 1/2" MPT

| PART# | FHT | MPT | FEMALE COPPER SWEAT |
|-------|------|------|---------------------|
| 2144 | 3/4" | 1/2" | 1/2" |

ADAPTER MALE HOSE (BOTH ENDS) - FEMALE PIPE



One end tapped 1/2" FPT

| PART# | MHT | MHT | FPT |
|-------|------|------|------|
| 2151 | 3/4" | 3/4" | 1/2" |

EVAPORATIVE COOLER DRAIN



- With washer & locknut

| PART# | MHT | FPT |
|-------|------|------|
| 2145 | 3/4" | 1/2" |

ADAPTER MALE HOSE - FEMALE PIPE



| PART# | MHT | FPT |
|-------|------|------|
| 2146 | 3/4" | 3/4" |

ADAPTER, 3/4" FHT x 3/4" FHT



| PART# | FHT | FHT |
|-------|------|------|
| 2149 | 3/4" | 3/4" |

ADAPTER DUAL SWIVEL - FEMALE HOSE



| PART# | FHT | FHT |
|-------|------|------|
| 2153 | 3/4" | 3/4" |

ACCESS DOORS - METAL

GENERAL PURPOSE
ACCESS PANELS

Non-Rated Flush Door For Drywall, Masonry, & Tile



Wall Opening: Allow additional 1/8"
- 3/8" for rough wall opening.

- Door: 14 gauge steel (0.078 inch thick)
- Frame: 16 gauge steel (0.060 inch thick), 1" Wide
- Hinge: Pin hinge
- Latch: Screwdriver operated cam latch
- Finish: Phosphate dipped with grey prime coat
- Packaging: one panel per carton

| PART# | SIZE | CAM LOCKS |
|--------|-----------|-----------|
| 350606 | 6" x 6" | 1 |
| 350808 | 8" x 8" | 1 |
| 351010 | 10" x 10" | 1 |
| 351212 | 12" x 12" | 1 |
| 351414 | 14" x 14" | 1 |
| 351616 | 16" x 16" | 1 |
| 351818 | 18" x 18" | 1 |
| 352424 | 24" x 24" | 5 |
| 353030 | 30" x 30" | 5 |
| 353636 | 36" x 36" | 5 |

FIRE RATED ALL PURPOSE INSULATED ACCESS DOOR



- **Door:** 20 gauge cold rolled steel
- **Frame:** 16 gauge cold rolled steel with 1" flange
- **Hinge:** Flush continuous piano hinge
- **Latch:** Knurled knob/key operated latch bolt
- **Finish:** Phosphate dipped and prime coated
- **Insulation:** 2" thick fire rated mineral fiber
- UL listed "B" label for 1-1/2 hours in walls (maximum temperature rise to 250° F in 30 min.)
- Warnock-Hersey listed for 3 hours in ceilings
- Call LYNCAR for sizes not listed



| PART# | SIZE |
|--------|-----------|
| 361212 | 12" x 12" |
| 361818 | 18" x 18" |
| 362424 | 24" x 24" |

FIRE RATED ALL PURPOSE UNINSULATED ACCESS DOOR



- **Door:** 14-gauge cold rolled steel
- **Frame:** 16-gauge cold rolled Steel with 1" flange
- **Hinge:** Flush continuous piano hinge
- **Latch:** Knurled knob/key operated latch bolt
- **Finish:** Phosphate dipped and prime coated
- **Insulation:** None
- UL listed for 1-1/2 hours in walls only
- No temperature rise rating.No ceiling rating
- Call LYNCAR for sizes not listed



| PART# | SIZE |
|--------|-----------|
| 370808 | 8" x 8" |
| 371212 | 12" x 12" |
| 371818 | 18" x 18" |
| 372424 | 24" x 24" |

SPECIALTIES

ACCESS DOORS - PLASTIC

ACCESS PANEL - ABS PLASTIC



- Made from UV stabilized high-impact ABS, the textured panel surface can be painted, wallpapered or tiled to match any décor and are approved for indoor or outdoor use
- Panels fasten on all four sides to prevent sagging
- Panels can be flush or surface mounted

| PART# | SIZE |
|---------------|-----------|
| 300808 | 8" x 8" |
| 300609 | 6" x 9" |
| 301414 | 14" x 14" |

ACCESS PANEL, PLASTIC, SNAP



- No framing required
- Fast Installation
- Paint or wallpaper after installation
- Easy to cover up plumbing valves or electrical cables etc.
- Retail packaged

| PART# | SIZE |
|---------------|-----------|
| 310808 | 8" x 8" |
| 311212 | 12" x 12" |

ACCESS PANEL - FLUIDMASTER



- FLUIDMASTER, no framing access panel
- Fast installation
- Easy to cover up plumbing valves or electrical cables etc.

| PART# | DESCRIPTION |
|---------------|-------------|
| FM0808 | 8" x 8" |
| FM1414 | 14" x 14" |

WATER HEATER PARTS

REPLACEMENT CORDS

Disposer / Furnaces / Timers/ Etc.



- LYNCAR replacement cords for disposer, timers, & furnaces are CSA approved
- Available with an angle or straight plug cap
- Free and split ends, ends stripped at 5/8"
- 13A rating with 16/3 cords



| PART# | TYPE | LENGTH |
|-------------|---------------|--------|
| 8121 | Angle plug | 3 ft |
| 8122 | Angle plug | 4 ft |
| 8124 | Angle plug | 6 ft |
| 8125 | Angle plug | 8 ft |
| 8130 | Straight plug | 3 ft |
| 8131 | Straight plug | 4 ft |
| 8133 | Straight plug | 6 ft |
| 8134 | Straight plug | 8 ft |

HEAVY DUTY ELEMENT WRENCH



- Removes stubborn water heater elements
- Heavy duty construction
- 1-1/2" elements

| PART# | DESCRIPTION |
|-------------|---------------------------|
| 4946 | Heavy duty element wrench |

BOILER PLUG



- Screw on boiler plug

| PART# | DESCRIPTION |
|-------------|-------------|
| 4950 | Boiler plug |

THERMOCOUPLES - COPPER



- All thermocouples are furnished with universal adapters

| PART# | LENGTH |
|-------------|--------|
| 9500 | 18" |
| 9501 | 24" |
| 9502 | 30" |
| 9503 | 36" |
| 9504 | 48" |

ELEMENT GASKET

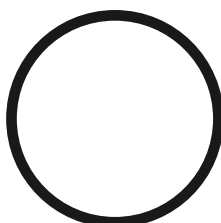

- Gaskets for replacement elements

| PART# | DESCRIPTION |
|--------------|-------------------------|
| 15520 | Bolt on element gasket |
| 15521 | Screw on element gasket |

SPECIALTIES

WATER HEATER PARTS

WATER HEATER ELEMENT

Element Style for 1500 Watt



Element Style for 3000 & 4500 Watt



- LYNCAR's quality hot water elements are manufactured to OEM standards
- Available in several voltages and styles
- Screw in, four bolt

| FOUR BOLT | SCREW IN | WATTS / VOLTAGE / DENSITY |
|--------------|--------------|-----------------------------------|
| 15500 | 15550 | 1500 watt / 120 volt / 75 density |
| 15510 | 15560 | 3000 watt / 240 volt / 75 density |
| 15515 | 15565 | 4500 watt / 240 volt / 75 density |

WATER HEATER PAN - PLASTIC



- For electric water heaters ONLY
- Durable plastic pans will not rust, corrode or crack
- 1" drain fitting included- 2-1/2" high sides
- Pre-cut side opening for drain fitting
- Box quantity only

| PART# | MATERIAL | SIZE |
|--------------|----------|------|
| 11500 | Plastic | 24" |
| 11501 | Plastic | 26" |
| 11502 | Plastic | 30" |

WATER HEATER PAN - ALUMINUM



- For gas or electric water heaters
- Will not rust, corrode or crack
- 1" drain fitting included
- Pre-cut side opening for drain fitting
- Box quantity only

| PART# | MATERIAL | SIZE |
|--------------|----------|------|
| 11503 | Aluminum | 24" |
| 11504 | Aluminum | 26" |
| 11505 | Aluminum | 30" |

WATER HEATER ANODE ROD



11509 Aluminum Flexible (3 Section)

- Box quantity only

| PART# | OD | SIZE | DESCRIPTION |
|--------------|------|------|---------------------------------|
| 11507 | 5/8" | 42" | Aluminum |
| 11508 | 3/4" | 42" | Aluminum |
| 11509 | 3/4" | 42" | Aluminum flexible (3 Section) |
| 11510 | 3/4" | 42" | Aluminum with dielectric nipple |

WALL PLATES

SPLIT PLASTIC FLOOR & CEILING PLATE

- Simply bend and place around pipe.
- Chrome or white finish 100% rustproof
- Non-corrosive, non-breakable



IF WHITE IS REQUIRED ADD SUFFIX "W" TO PART#

| PART# | IPS | CWT | OD |
|--------|--------|--------|---------|
| 202856 | 1/2" | | 2-3/4" |
| 202857 | 3/4" | | 3" |
| 202858 | 1" | | 3-1/4" |
| 202859 | 1-1/4" | | 3-1/2" |
| 202860 | 1-1/2" | | 4-1/4" |
| 202861 | 2" | | 4-1/4" |
| 202862 | 2-1/2" | | 5-1/4" |
| 202863 | 3" | | 5-3/4" |
| 202864 | 4" | | 6-3/4" |
| 202865 | 5" | | 8-1/2" |
| 202866 | 6" | | 9-3/4" |
| 202868 | 8" | | 12-3/4" |
| 202873 | | 1/2" | 2-1/2" |
| 202874 | | 3/4" | 2-3/4" |
| 202875 | | 1" | 3" |
| 202876 | | 1-1/4" | 3-1/4" |
| 202877 | | 1-1/2" | 3-1/2" |
| 202878 | | 2" | 4-1/2" |

SPECIALTIES

PLATE - FLOOR & CEILING - SURE GRIP

- Chrome plated steel
- Light pattern - no springs



| PART# | IPS | CWT | OD |
|--------|--------|--------|--------|
| NA | 3/8" | | 3" |
| 207800 | 1/2" | | 2-3/4" |
| 207805 | 3/4" | | 2-3/4" |
| 207810 | 1" | | 3-1/2" |
| 207815 | 1-1/4" | 1-1/4" | 3-1/2" |
| 207820 | 1-1/2" | 1-1/2" | 3-1/2" |
| 207825 | 2" | | 4-1/2" |
| 207830 | | 1/2" | 3" |
| 207835 | | 3/4" | 2-3/4" |
| 207840 | | 1" | 2-3/4" |
| 207845 | | 1-1/4" | 3-1/2" |
| 207850 | | 1-1/2" | |

PLATE - FLOOR & CEILING - HEAVY PATTERN W/ SPRINGS

- Chrome plated steel



| PART# | IPS | OD |
|--------|--------|--------|
| 207700 | 1/2" | 2-3/4" |
| 207705 | 3/4" | 2-3/4" |
| 207710 | 1" | 3-1/4" |
| 207715 | 1-1/4" | 3-1/2" |
| 207720 | 1-1/2" | 4" |
| 207725 | 2" | 4-1/2" |
| 207730 | 2-1/2" | 5-1/2" |
| 207735 | 3" | 6" |
| 207740 | 4" | 6-1/2" |
| 207745 | 5" | 9" |
| 207750 | 6" | 9-3/4" |
| 207755 | 8" | 13" |
| 207760 | 10" | 16" |

SPECIALTIES

**CAST IRON WALL
PLATE W/ SET SCREW**



- LYNCAR's cast iron wall plate is comparable to the GRINNELL 395 wall plate
- Available from 1/2" to 4" plated finish
- Galvanized finish

| PART# | SIZE |
|--------|--------|
| 95100G | 1" |
| 95114G | 1-1/4" |
| 95112G | 1-1/2" |
| 95200G | 2" |
| 95212G | 2-1/2" |
| 95300G | 3" |
| 95400G | 4" |

CAST IRON DRAIN CAP



- Sewer cap
- Clamps to soil pipe spigot
- Fits 3" or 4" pipe

| PART# | DESCRIPTION |
|-------|------------------------------|
| 60005 | Cast iron drain cap, painted |

CLEANOUT - COVER PLATES



- Polished stainless steel
- Countersunk hole will accept both 1/4" and 5/16" bolts
- Covers unsightly waste cleanouts
- Polished face covered with protective paper
- 22 gauge metal

| PART# | TYPE | PIPE SIZE |
|-------|--------------------------------------|---------------------|
| 1629 | Cover plate screw ONLY | 1/4" x 20" x 2-1/2" |
| 1649 | Cover plate screw ONLY | 1/4" x 20" x 4" |
| 1659 | Cover plate screw ONLY | 5/16" x 18" x 4" |
| 1840 | Cover plate w/ 1/4" x 20" x 4" bolts | 3" |
| 1841 | Cover plate w/ 1/4" x 20" x 4" bolts | 4" |
| 1842 | Cover plate w/ 1/4" x 20" x 4" bolts | 5" |
| 1843 | Cover plate w/ 1/4" x 20" x 4" bolts | 6" |
| 1844 | Cover plate w/ 1/4" x 20" x 4" bolts | 7" |
| 1845 | Cover plate w/ 1/4" x 20" x 4" bolts | 8" |

DIELECTRIC UNIONS



| PART# | TYPE | SIZE |
|-------|-------------|-------------------------|
| 2590 | FPT x sweat | 3/4" FIP x 1/2" CWT |
| 2592 | FPT x sweat | 1/2" FIP x 1/2" CWT |
| 2594 | FPT x sweat | 3/4" FIP x 3/4" CWT |
| 2596 | FPT x sweat | 1" FIP x 1" CWT |
| 2597 | FPT x sweat | 1-1/4" FIP x 1-1/4" CWT |
| 2598 | FPT x sweat | 1-1/2" FIP x 1-1/2" CWT |
| 2599 | FPT x sweat | 2" FIP x 2" CWT |
| 2589 | MPT x sweat | 3/4" MIP x 3/4" CWT |
| 2591 | MPT x sweat | 3/4" MIP x 1/2" CWT |

CLEANOUT PLUGS

BRASS PLUGS CLEANOUT - SOUTHERN STYLE

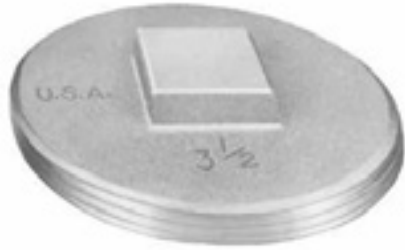

| PART# | SIZE | DESCRIPTION |
|-------------|--------|--------------------|
| 1846 | 1-1/2" | Raised head |
| 1847 | 2" | Raised head |
| 1848 | 2-1/2" | Raised head |
| 1849 | 3" | Raised head |
| 1850 | 3-1/2" | Raised head |
| 1851 | 4" | Raised head |
| 1875 | 5" | Raised head |
| 1876 | 6" | Raised head |
| 1852 | 1-1/2" | Countersunk square |
| 1853 | 2" | Countersunk square |
| 1854 | 2-1/2" | Countersunk square |
| 1855 | 3" | Countersunk square |
| 1856 | 3-1/2" | Countersunk square |
| 1857 | 4" | Countersunk square |
| 1878 | 5" | Countersunk square |
| 1879 | 6" | Countersunk square |

- Countersunk plugs can be tapped with 5/16" threads upon request.
- Countersunk plugs may be ordered "not tapped through" by adding -NT to the PART#

BRASS PLUGS CLEANOUT - UPC STYLE



| PART# | SIZE | DESCRIPTION |
|-------------|--------|---------------------|
| 1858 | 1-1/2" | Raised head |
| 1859 | 2" | Raised head |
| 1860 | 2-1/2" | Raised head |
| 1861 | 3" | Raised head |
| 1862 | 3-1/2" | Raised head |
| 1863 | 4" | Raised head |
| 1890 | 5" | Raised head |
| 1864 | 1-1/2" | Countersunk slotted |
| 1865 | 2" | Countersunk slotted |
| 1866 | 2-1/2" | Countersunk slotted |
| 1867 | 3" | Countersunk slotted |
| 1868 | 3-1/2" | Countersunk slotted |
| 1869 | 4" | Countersunk slotted |
| 1891 | 5" | Countersunk slotted |

- Countersunk plugs can be tapped with 5/16" threads upon request.
- Countersunk plugs may be ordered "not tapped through" by adding -NT to the PART#

UNIFORM SCHEME FOR THE IDENTIFICATION OF PIPING SYSTEMS APPLICATIONS

Positive identification of a piping system shall be done by lettered legend and colour. The name of a given content shall be spelled in full or abbreviated. Colour bands cannot be used alone without a legend.

The markers (hereafter referred to as a legend on a colour band) should be applied to pipe to designate the four main classifications and should be installed at frequent intervals, close to all valves, adjacent to all changes in direction where pipe passes through walls and floors or at junction points of distribution.

When arrows are used they must point away from pipe marker legend and in direction of flow. Double arrows should be used if flow can be in either direction.

These Markers are colour coded according to American National Standard Institute Specifications ANSI A- 13.1, along with a legend on the colour markers insures double identification protection (OSHA 1910.144, 1910.147, and 1910.261, 1910.262 and 1910.264, ANSI A-31.1.1981)

Material is a high quality performance 6 mil stabilized vinyl. Will not tear, durable and PRINTING IS BURIED under a protective cover. Will take temperatures up to 260°F. For Indoor or outdoor use.

| Recommend Label Selection | | |
|------------------------------|-----------------|-------------|
| Outside Diameter Pipe System | Size of Letters | Label Style |
| 1" to 2-1/2" | 1" | A |
| 2 - 1/2" to 7" | 2" | B |

Style "A"
1" Letters on a
1-1/8" x 14-1/2" Backer
4 per card

| | |
|-------------|-------------|
| NATURAL GAS | NATURAL GAS |
| NATURAL GAS | NATURAL GAS |

Style "B"
2" Letters on a
2-1/4" x 14-1/2" Backer
1 per card

NATURAL GAS

STANDARD COLOUR SYSTEMS PER OSHA & ANSI

| | |
|-----------------|----------------------------------|
| NATURAL GAS | Yellow - Dangerous Material |
| SPRINKLER WATER | Red - Fire Protection Equip. |
| COMPRESSED AIR | Blue - Protective Material |
| CITY WATER | Green - Safe Material (Press-On) |

DANGEROUS MATERIALS. This group includes materials which are hazardous to life or property because they are easily ignited, toxic, corrosive at high temperatures and pressures, productive of poisonous gases or are in themselves poisonous. It also includes materials that are known ordinarily as fire producers or explosives.

FIRE PROTECTION, MATERIALS AND EQUIPMENT. This classification includes sprinkler systems and other firefighting or fire protection equipment. The identification for this group of materials may also be used to identify or locate such equipment as alarm boxes, extinguishers, fire blankets, fire doors, hose connections, hydrants and any other fire-fighting equipment.

PROTECTIVE MATERIALS. This group includes materials which are piped through plants for the express purpose of being available to prevent or minimize the hazard of the dangerous materials above mentioned. It would include certain special gases which are antidotes, to counteract poisonous fumes, piped for the express purpose of release in case of danger. This classification also covers protective materials for purposes other than for fire protection which is covered under the section Fire Protection Materials and Equipment.

SAFE MATERIALS. This group includes those materials involving little or no hazard to life or property in their handling. This classification includes materials at low pressures and temperatures which are neither toxic nor poisonous and will not produce fire or explosions. People working on piping systems carrying these materials run little risk even though the system had not been emptied.

PIPE LABELS - PRESSURE SENSITIVE



Many other phrases available now at LYNCAR.
Please let us know your requirements.
All pipe markers can be customer made (min 25 cards)

Label Style "A"
1" Letters on a
1-1/8" x 7-1/4" Backer
4 per card

Label Style "B"
2" Letters on a
2-1/4" x 14-1/2" Backer
1 per card

| PART# | LABEL STYLE | WORDING | LETTER COLOUR | CARD COLOUR |
|--------|-------------|--------------------|---------------|-------------|
| 75105 | A | Chilled Water Ret. | White | Green |
| 75104 | B | Chilled Water Ret. | White | Green |
| 75107 | A | Chilled Water Sup. | White | Green |
| 75106 | B | Chilled Water Sup. | White | Green |
| 75101 | A | City Water | White | Green |
| 75100 | B | City Water | White | Green |
| 75128 | 2 per card | CO2 | Black | Yellow |
| 75103 | A | Compressed Air | Black | Yellow |
| 75102 | B | Compressed Air | Black | Yellow |
| 75222 | A | Condensate | White | Green |
| 75121 | A | Diesel Fuel | Black | Yellow |
| 75120 | B | Diesel Fuel | Black | Yellow |
| 75109 | A | Dom. Cold Water | White | Green |
| 75108 | B | Dom. Cold Water | White | Green |
| 75109R | A | Dom. C.W. Return | White | Green |
| 75108R | B | Dom. C.W. Return | White | Green |
| 75108S | B | Dom. C.W. Supply | White | Green |
| 75111 | A | Dom. Hot Water | Black | Yellow |
| 75110 | B | Dom. Hot Water | Black | Yellow |
| 75099 | B | Dom. H.W. Recirc. | Yellow | Black |
| 75113 | A | Dom. H.W. Recirc. | Black | Yellow |
| 75112 | B | Dom. H.W. Recirc. | Black | Yellow |
| 75115 | A | Dom. H.W. Recirc. | White | Green |
| 75114 | B | Dom. H.W. Recirc. | White | Green |
| 75119 | A | Dom. H.W. Supply | White | Green |
| 75118 | B | Dom. H.W. Supply | White | Green |
| 75119R | A | Dom. H.W. Return | White | Green |
| 75118R | B | Dom. H.W. Return | White | Green |
| 75116 | B | Drain | White | Green |
| 75117 | A | Drain | White | Green |
| 75183 | A | Eau Gicleur | Red | White |
| 75184 | B | Eau Gicleur | Red | White |
| 75123 | A | Fan Coil Return | Black | Yellow |
| 75122 | B | Fan Coil Return | Black | Yellow |
| 75125 | A | Fan Coil Supply | Black | Yellow |
| 75124 | B | Fan Coil Supply | Black | Yellow |

SPECIALTIES

Label Style "A"
 1" Letters on a
 1-1/8" x 7-1/4" Backer
 4 per card

Label Style "B"
 2" Letters on a
 2-1/4" x 14-1/2" Backer
 1 per card

| PART# | LABEL STYLE | WORDING | LETTER COLOUR | CARD COLOUR |
|--------------|--------------------|-----------------------|----------------------|--------------------|
| 75191 | A | Fire Protection Water | Red | White |
| 75192 | B | Fire Protection Water | Red | White |
| 75127 | A | Fuel Oil | Black | Yellow |
| 75126 | B | Fuel Oil | Black | Yellow |
| 75160F | A | Gaz Naturel | Black | Yellow |
| 75159F | B | Gaz Naturel | Black | Yellow |
| 75187 | A | Gicleur | Red | White |
| 75188 | B | Gicleur | Red | White |
| 75129 | A | Glycol | Black | Yellow |
| 75197 | A | Glycol | Black | Yellow |
| 75198 | B | Glycol | Black | Yellow |
| 75129R | A | Glycol | White | Red |
| 75128R | B | Glycol | White | Red |
| 75135 | A | Glycol Cool. Ret. | Black | Yellow |
| 75134 | B | Glycol Cool. Ret. | Black | Yellow |
| 75137 | A | Glycol Cool. Sup. | Black | Yellow |
| 75136 | B | Glycol Cool. Sup. | Black | Yellow |
| 75133 | A | Glycol Htg. Ret. | Black | Yellow |
| 75132 | B | Glycol Htg. Ret. | Black | Yellow |
| 75131 | A | Glycol Htg. Sup. | Black | Yellow |
| 75130 | B | Glycol Htg. Sup. | Black | Yellow |
| 75138 | B | Glycol Make-up | Black | Yellow |
| 75215 | A | Heating Return | Black | Yellow |
| 75216 | B | Heating Return | Black | Yellow |
| 75217 | A | Heating Supply | Black | Yellow |
| 75218 | B | Heating Supply | Black | Yellow |
| 75150 | B | Hot Water Heating | Yellow | Black |
| 75210 | A | H.W. Heating Return | Yellow | Black |
| 75211 | B | H.W. Heating Return | Yellow | Black |
| 75153 | A | Low Press. Cond. | Black | Yellow |
| 75154 | B | Low Press. Steam | Black | Yellow |
| 75155 | A | Low Press. Steam | Black | Yellow |
| 75156 | B | Med. Press. Cond. | Black | Yellow |
| 75157 | A | Med. Press. Cond. | Black | Yellow |
| 75158 | B | Med. Press. Steam | Black | Yellow |
| 75159 | A | Natural Gas | Black | Yellow |
| 75160 | B | Natural Gas | Black | Yellow |
| 75159A | A | Nitrogen | Blue | White |
| 75166N | A | Non Potable Water | White | Green |
| 75166NP | A | Non Potable Water | White | Green |
| 75165N | B | Non Potable Water | White | Green |
| 75161 | A | Oxygen | White | Green |
| 75162 | B | Oxygen | White | Green |
| 75163 | A | Plumbing Vent | White | Green |
| 75164 | B | Plumbing Vent | White | Green |

Label Style "A"
1" Letters on a 1-1/8" x 7-1/4"
Backer
4 per card

Label Style "B"
2" Letters on a
2-1/4" x 14-1/2" Backer
1 per card

| PART# | LABEL STYLE | WORDING | LETTER COLOUR | CARD COLOUR |
|--------|-------------|-------------------------|---------------|-------------|
| 75165 | A | Potable Water | White | Green |
| 75166 | B | Potable Water | White | Green |
| 75167 | A | Propane Gas | Black | Yellow |
| 75168 | B | Propane Gas | Black | Yellow |
| 75207 | A | Return | Yellow | Black |
| 75207A | B | Return | Yellow | Black |
| 75209 | B | Reverse Osmosis Water | White | Green |
| 75174S | B | Sanitary | Green | White |
| 75213 | B | Sanitary Drain | Green | White |
| 75173 | A | Sanitary Sewer | White | Green |
| 75174 | B | Sanitary Sewer | White | Green |
| 75141 | A | Siamese | Red | White |
| 75140 | B | Siamese | Red | White |
| 75181 | A | Sprinkler Water | Red | White |
| 75182 | B | Sprinkler Water | Red | White |
| 75185 | A | Sprinkler Fire | Red | White |
| 75186 | B | Sprinkler Fire | Red | White |
| 75169 | A | Steam Supply | Black | Yellow |
| 75170 | B | Steam Supply | Black | Yellow |
| 75189 | A | Standpipe | Red | White |
| 75190 | B | Standpipe | Red | White |
| 75171 | A | Storm Sewer | White | Green |
| 75172 | B | Storm Sewer | White | Green |
| 75175W | B | Storm Water | White | Green |
| 75208 | A | Supply | Yellow | Black |
| 75208A | B | Supply | Yellow | Black |
| 75214 | B | Tempered Dom. Hot Water | Yellow | Black |
| 75199 | B | Tempered Water Return | White | Green |
| 75175 | A | Arrows | Red | White |
| 75176 | B | Arrows | Red | White |
| 75177 | A | Arrows | Yellow | Black |
| 75178 | B | Arrows | Yellow | Black |
| 75179 | A | Arrows | Red | Green |
| 75180 | B | Arrows | Red | Green |
| 75175 | A | Arrows | Red | White |
| 75176 | B | Arrows | Red | White |
| 75177 | A | Arrows | Yellow | Black |
| 75178 | B | Arrows | Yellow | Black |
| 75179 | A | Arrows | Red | Green |
| 75180 | B | Arrows | Red | Green |

PIPE LABELS ON-A-ROLL

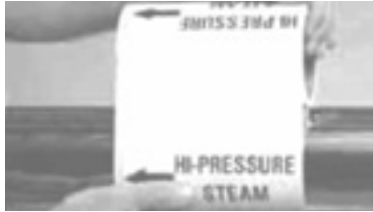

Pipe Markers on-a-roll are manufactured from pressure sensitive vinyl with aggressive permanent adhesive. This style of marker provides 360° visibility.

The ABCs of ordering "Pipe Markers On-A-Roll"

STEP A Select Tape & Letter Colour on Chart "A"

STEP B Select Wording from Chart "B"

STEP C Check your Usage requirements on Chart "C"

Sample Pipe Marker On-A-Roll Ordering

Product Code + "A" + "B" = **Part Number**

PMR - **BY** - **114**

STEP "A" - Select Tape & Lettering Colour

| COLOUR CODE | STANDARD COLOURS |
|-------------|------------------|
| BY | Black on Yellow |
| WG | White on Green |
| WR | White on Red |
| WB | White on Blue |

STEP "B" - Select a Wording

| ORDER CODE | STANDARD WORDING | ORDER CODE | STANDARD WORDING |
|------------|--------------------|------------|-------------------|
| 99 | "Custom Wording" | 118 | Glycol Cool. Sup. |
| 101 | City Water | 119 | Low Press. Cond. |
| 102 | Compressed Air | 120 | Low Press. Steam |
| 103 | Chilled Water Ret. | 121 | Med. Press. Cond. |
| 104 | Chilled Water Sup. | 122 | Med. Press. Steam |
| 105 | Dom. Cold Water | 123 | Natural Gas |
| 106 | Dom. Hot Water | 124 | Oxygen |
| 107 | Dom. H.W. Recirc. | 125 | Plumbing Vent |
| 108 | Drain | 126 | Potable Water |
| 109 | Dom H.W. Supply | 127 | Propane Gas |
| 110 | Diesel Fuel | 128 | Steam Supply |
| 111 | Fan Coil Return | 129 | Storm Sewer |
| 112 | Fan Coil Supply | 130 | Sanitary Sewer |
| 113 | Fuel Oil | 131 | Arrows |
| 114 | Glycol | 132 | Sprinkler Water |
| 115 | Glycol Htg. Sup. | 133 | Sprinkler Fire |
| 116 | Glycol Htg. Ret. | 134 | Standpipe |
| 117 | Glycol Cool. Ret. | | |

STEP "C" - Calculate Rolls Required

| 1 ROLL 30' LONG WITH LABEL | |
|----------------------------|------------|
| PIPE OD | TIMES |
| 1" | 100 |
| 2" | 55 |
| 3" | 36 |
| 4" | 27 |
| 5" | 20 |
| 6" | 18 |

SNAP PLASTIC LABELS



Pipe Huggers are the best form of markers on todays market. These markers are constructed from plastic and are pre coiled for pipes from 1/2" thru 6". Constructed from .020 rigid vinyl, with subsurface printing for maximum chemical resistance. This style of marker provides 360° visibility.

Temperature rating for pipe huggers:
-40 degrees F. to 140 degrees F.

STEP THE "ABCs" of Pipe Hugger Ordering

- A** Select "Hugger Size" from Chart "A"
- B** Select Hugger Backer and Lettering Colour from Chart "B"
- C** Select "Wording" from Chart "C" or provide your own custom wording using Code 99

Sample Pipe Hugger Ordering

"A" + "B" + "C" = Part Number

PH4 -BY- 114

STEP "A"
Select a Pipe Hugger Size

| HUGGER SIZE CODE | PIPE SIZE RANGE (OD) | LETTER SIZE |
|------------------|----------------------|-------------|
| PH0 | 1/2" | 1/2" |
| PH1 | 3/4" to 1-1/4" | 1/2" |
| PH2 | 1-1/4" to 2-3/8" | 3/4" |
| PH3 | 2-3/8" to 4-1/2" | 1-1/4" |
| PH4 | 4-1/2" to 6" | 1-1/4" |
| PH5 | 6" to 8" | 2-1/4" |
| PH6 | 8" to 10" | 2-1/2" |
| PH7 | 10" to 15" | 3-1/2" |

STEP "B"
Select a Colour Scheme

| COLOUR CODE | STANDARD COLOURS |
|-------------|------------------|
| BY | Black on Yellow |
| WG | White on Green |
| WR | White on Red |
| WB | White on Blue |

STEP "C"
Select a Wording

| ORDER | WORDING | ORDER | WORDING |
|------------|--------------------|------------|-------------------|
| 99 | "Custom Wording" | 116 | Glycol Htg. Ret. |
| 101 | City Water | 117 | Glycol Cool. Ret. |
| 102 | Compressed Air | 118 | Glycol Cool. Sup. |
| 103 | Chilled Water Ret. | 119 | Low Press. Cond. |
| 104 | Chilled Water Sup. | 120 | Low Press. Steam |
| 105 | Dom. Cold Water | 121 | Med. Press. Cond. |
| 106 | Dom. Hot Water | 122 | Med. Press. Steam |
| 107 | Dom. H.W. Recirc. | 123 | Natural Gas |
| 108 | Drain | 124 | Oxygen |
| 109 | Dom H.W. Supply | 125 | Plumbing Vent |
| 110 | Diesel Fuel | 126 | Potable Water |
| 111 | Fan Coil Return | 127 | Propane Gas |
| 112 | Fan Coil Supply | 128 | Steam Supply |
| 113 | Fuel Oil | 129 | Storm Sewer |
| 114 | Glycol | 130 | Sanitary Sewer |
| 115 | Glycol Htg. Sup. | 131 | Arrows |

SPECIALTIES

BARRICADE TAPE



- 1000' roll single

ARROW TAPE



- 2" wide rolls by 55 yard, 3 mil PVC tape

| PART# | DESCRIPTION |
|--------------|---------------------------|
| 15000 | CAUTION |
| 15014 | CAUTION MEN WORKING |
| 15018 | CAUTION CONSTRUCTION AREA |

| PART# | DESCRIPTION |
|---------------|---------------------------|
| 75195R | Red tape / white arrow |
| 75195Y | Yellow tape / black arrow |
| 75195G | Green tape / white arrow |

NATURAL GAS ID TAPE



- Natural gas pipe identification tape
 - Supplied by the self adhesive roll
 - 2" wide rolls by 60 yard, 3 mil PVC tape

ANCHOR KIT



- EACH SET CONTAINS:
 - 100 #8-10 collar anchors
 - 100 #10 x 1" Phillips with Hex head screws
 - 1/4" carbide tipped masonry drill
 - Transparent, reusable box
 - Phillips hex head screws allow a nutdriver, nut setter or screwdriver to be used.

| PART# | DESCRIPTION |
|----------------|---------------------|
| 75195NG | Natural gas ID tape |

| PART# | DESCRIPTION |
|-------------|-------------|
| 1600 | Anchor kit |

CHAIN - BRASS SIGN HANGING



- Brass sign hanging chain for signage and tags
 - 100 and 250-foot rolls or pre-cut 4" length with connector



BRASS TAGS



- Solid brass tags
 - 1-1/4" diameters
 - Black ink filled
 - Sold as sets with
 - 4" brass hanging chain
 Yes, we take custom orders too !

| PART# | DESCRIPTION |
|---------------|------------------------------|
| 305735 | Roll of chain brass 100' |
| 305740 | Roll of chain brass 250' |
| 305741 | Roll of chain brass 500' |
| 305745 | Clips for above (per 100) |
| 305730 | Sign chain 4 1/2" long brass |

| PART# | DESCRIPTION |
|---------------|----------------------------|
| 305749 | Blanks (No chain) |
| 305750 | Set # 1 - 6 with chain |
| 305755 | Set # 1 - 7 with chain |
| 305760 | Set # 1 - 25 with chain |
| 305765 | Set # 1 - 50 with chain |
| 305770 | Set # 1 - 100 with chain |
| 305775 | Brass Tag "A" |
| 305780 | Brass Tag "B" |
| 305772 | Set # 101 - 200 with chain |
| 305773 | Set # 201 - 300 with chain |

FIRE PROTECTION

In addition to our plumbing business, LYNCAR has been a leading supplier to the Canadian fire protection industry for over 40 years. LYNCAR provides fire protection wholesalers with thousands of products including:

- Escutcheons and wallplates
- A full line of GLOBE sprinkler heads
- Sprinkler gauges
- Signage and labels for fire protection systems
- Beam clamps, ring hangers and other pipe-hanging accessories for sprinkler systems
- Electrical items such as Potter switches
- Fire-rated specialty chemicals such as pipe sealants and premixed anti-freeze
- Specialty valves
- Head guards
- Many other fire sprinkler specialties

Please contact our order desk or check our website for more information on how we may serve your customers' fire protection needs, or to get our fire protection wholesale catalogue.

**Thousands
of Fire Sprinkler
Specialty Products**



One Source.

www.lyncar.com

SPRINKLER HEADS

**SPRINKLER HEADS – STANDARD RESPONSE
1/2" IPS**



G566115501



G56015502



G565115502

- Temperature rating 155°
- 5mm glass bulb sprinklers 1/2" orifice x 1/2" NPT
- K FACTOR 5.6
- cULus & FM approved

| PART# | DESCRIPTION |
|-------------------|---------------------------------------|
| G566115501 | Upright - 1/2" IPS brass |
| G567015502 | Horizontal sidewall - 1/2" IPS chrome |
| G565115502 | Pendent - 1/2" IPS chrome |

**SPRINKLER HEADS – QUICK RESPONSE
1/2" IPS**



G561515501



G562615502



G560115502

- Temperature rating 155°
- 3mm glass bulb sprinklers 1/2" orifice x 1/2" NPT
- K FACTOR 5.6
- cULus & FM approved

| PART# | DESCRIPTION |
|-------------------|---------------------------------------|
| G561515501 | Upright - 1/2" IPS brass |
| G562615502 | Horizontal sidewall - 1/2" IPS chrome |
| G560115502 | Pendent - 1/2" IPS chrome |

SPECIALTIES

SPRINKLER HEADS

HEAD - CONCEALED, S.R. & Q.R.
"THE INCH"

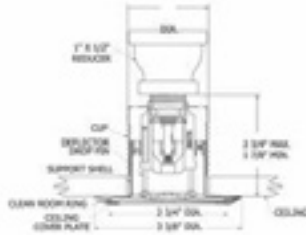

- Water working pressure rating – 175 PSI
- Factory tested hydrostatically to 500 PSI
- Maximum low temperature glass bulb rating is -67°F (-55°C)
- Strong wrap around pin, drop in design
- Available in 155°
- White plate 2-3/4" diameter
- cULus and FM approved

| PART# | DESCRIPTION |
|-------------|-------------------|
| G560615501W | Quick Response |
| G565315501W | Standard Response |

RESIDENTIAL "THE INCH"

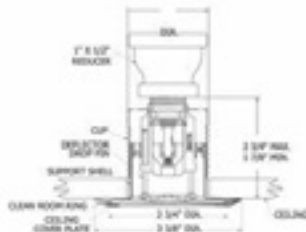

- Water working pressure rating – 175 PSI
- Factory tested hydrostatically to 500 PSI
- Maximum low temperature glass bulb rating is -67°F (-55°C)
- Strong wrap around pin, drop in design
- Available in 155°
- White plate 2-3/4" diameter
- cULus and FM approved

| PART# | DESCRIPTION |
|-------------|-------------|
| G490615501W | Residential |

RESIDENTIAL SPRINKLER HEAD - 1/2" IPS



- 3mm frangible glass bulb
- Residential sprinklers are the ultimate in life safety and fire control
- Install in accordance with the appropriate NFPA Standard 13, 13D or 13R and under the direction of the approving authorities having jurisdiction.
- Temperature rating 0 155° F (68° C)
- Water working pressure rating – 175 PSI
- Chrome pendent 155°
- cULus approved

| PART# | DESCRIPTION |
|------------|-----------------------|
| G561015502 | Pendent, K FACTOR 5.6 |

SPRINKLER SPECIALTIES

RECESSED ESCUTCHEON



- Recessed escutcheon for pendent sprinkler head
- Chrome or white standard
- Also available in black & brass
- Sprinkler head sold separately

| PART# | FINISH | IPS |
|--------|--------|------|
| 205200 | Chrome | 1/2" |
| 205215 | Chrome | 3/4" |
| 205210 | White | 1/2" |
| 205225 | White | 3/4" |

ESCUTCHEON - RECESSED THREADED 2 PC PLATE



- Made to allow for minor adjustments to pipe or ceiling pitch
- Can be removed or reinstalled, allowing access above removable ceiling panels without shutting down the sprinkler system
- Threaded skirt & cup for 1/2" adjustment

| PART# | DESCRIPTION |
|--------|-------------|
| 205213 | Chrome |
| 205214 | White |

ESCUTCHEON - RECESSED RETROFIT



- 3 piece recessed escutcheon
- Centre section splits into 2 pieces and snap together
- Chrome plated escutcheon without shutting down the system

| PART# | DESCRIPTION |
|---------|------------------|
| 205200R | Chrome, 1/2" IPS |

STANDARD ESCUTCHEON 1 PC



- Standard Escutcheon for pendent sprinkler head.
- Chrome or White standard.

| PART# | FINISH | IPS |
|---------|--------|------|
| 205100 | Chrome | 1/2" |
| 205105 | Chrome | 3/4" |
| 205110 | White | 1/2" |
| 205105W | White | 3/4" |

OVERSIZED REPAIR PLATE



- Increase the coverage area when using 2 pc recessed plates or 1 pc plates
- Used in repair when hole is oversized from previous sprinkler
- Also suitable for earthquake zone areas where 1" is required for the flange
- Total coverage is 5"
- Sprinkler head sold separately

| PART# | DESCRIPTION |
|--------|-------------|
| 205301 | Chrome |
| 205302 | White |

SPRINKLER SPECIALTIES

HEAD CABINETS



- LYNCAR stocks spare head cabinet for 6 or 12 heads
- Sprinkler head sold separately

PART# DESCRIPTION

| | |
|---------------|-------------|
| 305621 | 6 head box |
| 305619 | 12 head box |

HEAD GUARDS



305660



305699



305675



305692

- LYNCAR stocks many different head guards for fire sprinkler applications

PART# STYLE

| | |
|---------------|--|
| 305660 | Red 1 pc 2 hook 1/2" or 3/4" IPS |
| 305675 | Red 2 pc heavy duty 1/2" IPS |
| 305690 | Red 1 pc 2 hook with shield |
| 305692 | Mini guard chrome for 1/2" or 3/4" IPS |
| 305699 | Head guard for recessed plate |

ESCUTCHEON - RETROFIT



- These rings are used to conceal oversized holes and cutting errors in ceiling tiles, drywall or other ceiling materials
- These products split so the system does not have to be shut down or the sprinkler head removed. The 1-1/2" ID is standard and the 2-1/2" ID is for semi recessed escutcheons
- 4" coverage

PART# FINISH ID OD

| | | | |
|---------------|---------------|--------|----|
| 205240 | White - Kydex | 1-1/2" | 4" |
| 205242 | White - Kydex | 2-1/2" | 4" |

NIPPLES - CHEATER BRASS HEX



- 1/2" IPS brass cheater nipples, used when the sprinkler head requires adjustment down from the existing position

PART# ADJUSTMENT

| | |
|---------------|--------|
| 205623 | 1/2" |
| 205624 | 3/4" |
| 205625 | 1" |
| 205626 | 1-1/2" |
| 205627 | 2" |

POTTER FLOW & PRESSURE SWITCHES

SWITCH - POTTER FLOW

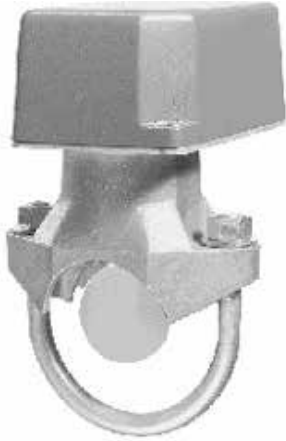

- Potter flow switch
- Paddle type flow switch
- Available from 1" to 10" pipe sizes
- Service pressure to 450 PSI,
- ULC and FM approved



| PART# | SIZE |
|----------------|-----------|
| 4070112 | 1/2" - 2" |
| 4070200 | 2" |
| 4070300 | 3" |
| 4070400 | 4" |
| 4070600 | 6" |

SWITCH - POTTER PRESSURE



- Potter pressure switches
- Single & double contacts
- ULC and FM approved



| PART# | DESCRIPTION |
|-----------------|--|
| 4071102A | Low pressure double contact (PS10-2A) |
| 407110 | Low pressure single contact (PS10) |
| 407140 | Air pressure single contact (PS40) ** |
| 4071120 | Pressure supervision switch (PS120) ** |

** Also available as double contact models

SWITCH - POTTER OSY & PCVS



part#404072 - OSY



part#404073 - PCVS

- Potter OSY & PCVS supervisory switches are double contact switches, for OSY valves or for PIB valves
- FM approved



| PART# | DESCRIPTION |
|---------------|-------------|
| 404072 | OSY |
| 404073 | PCVS |

SPECIALTIES

J

NOTES

SPECIALTIES

SECTION "K" HANGERS & FITTINGS INDEX

| | | | |
|-------------------------------|------|----------------------------|------|
| Anchor Kit | K-3 | Pipe Hooks | K-3 |
| Anchor Setting Tool | K-5 | Pipe Stays | K-6 |
| Anchors - Drop in | K-5 | Pipe Straps | K-3 |
| Angle Bracket | K-4 | Plugs - Square Head | K-15 |
| Beam Connector | K-5 | Repair Couplings | K-15 |
| Beam Clamp Wrench | K-1 | Ring Hanger | K-7 |
| Beam Clamps | K-1 | Rod Button | K-4 |
| Bell Hangers | K-4 | Rod Coupling | K-4 |
| Bolt - Lag | K-2 | Sammy Screw Tools | K-8 |
| Bolt - Stove | K-2 | Sammy Screws | K-8 |
| Boxes - Nipple | K-18 | Sammy Screws - Concrete | K-11 |
| Brass Fittings | K-12 | Sammy Screws - Steel | K-9 |
| Brass Fittings, Chrome | K-19 | Sammy Screws - Wood | K-10 |
| Brass Nipples | K-16 | Screws - Sammy | K-8 |
| Brass Nipples, Chrome Plated | K-21 | Screws - Sheet metal | K-2 |
| Brass Repair Couplings | K-15 | Screws - Wood | K-2 |
| Cable Ties | K-3 | Sheet Metal Screws | K-2 |
| Cap - Chrome | K-19 | Side Beam Connector | K-5 |
| Ceiling Flange | K-4 | Sockets - Eye | K-5 |
| Chrome Plated Brass Fittings | K-19 | Split Ring Hangers | K-6 |
| Chrome Plated Brass Nipples | K-21 | Sprinkler Ring Hanger | K-7 |
| Clamps - Beam | K-1 | Square Head Plugs | K-15 |
| Compression Fittings | K-24 | Stove Bolts | K-2 |
| Coupling - Brass Repair Short | K-15 | Tee Coupling - Iron Repair | K-15 |
| Coupling - Iron Long Repair | K-15 | Tie Bolt | K-4 |
| Coupling - Repair | K-15 | Toggle Wing | K-4 |
| Coupling - Rod | K-4 | Tote Tray | K-18 |
| Deck Flange | K-4 | Wood Screws | K-2 |
| Drop In Concrete Anchors | K-5 | Wrench - Beam Clamp | K-1 |
| Eye Socket | K-5 | | |
| Fittings - Brass | K-12 | | |
| Fittings - Chrome Brass | K-19 | | |
| Fittings - Compression | K-24 | | |
| Fittings - Flare Brass | K-22 | | |
| Flare Fittings | K-22 | | |
| Hanger - Bell | K-4 | | |
| Hanger - Insert Nut | K-4 | | |
| Hanger - J-Hook Plastic | K-7 | | |
| Hanger - Pipe Straps | K-3 | | |
| Hanger - Ring | K-7 | | |
| Hanger - Split Ring | K-6 | | |
| Hanger - Wire Pipe Hooks | K-3 | | |
| J-Hook Plastic Hangers | K-7 | | |
| Lag Bolts | K-2 | | |
| Nailing Plates | K-3 | | |
| Nipple Boxes | K-18 | | |
| Nipples - Brass | K-16 | | |
| Nipples - Chrome Brass | K-21 | | |
| Perlin Clamps | K-1 | | |

BEAM CLAMPS

BEAM CLAMP - STANDARD



- LYNCAR Beam Clamps:**
- Black or zinc plated finishes
 - Malleable iron ASTM A47
 - Grade 32510
 - 3/8" UNC set screw thread
 - ULC, UL, & FM approved



| PART# | FINISH | ROD SIZE | MAX. PIPE SIZE | MAX. REC. LOAD / LBS. |
|----------------|--------|----------|----------------|-----------------------|
| 109038 | Black | 3/8" | 3/4 to 4" | 400 |
| 109012 | Black | 1/2" | 5" to 8" | 500 |
| 109038G | Plated | 3/8" | 3/4 to 4" | 400 |
| 109012G | Plated | 1/2" | 5" to 8" | 500 |

BEAM CLAMP - WIDE MOUTH



- LYNCAR Beam Clamps:**
- Black or zinc plated finishes
 - Malleable iron ASTM A47
 - Grade 32510
 - 3/8" UNC set screw thread
 - ULC, UL, & FM approved



| PART# | FINISH | ROD SIZE | MAX. PIPE SIZE | MAX. REC. LOAD / LBS. |
|-----------------|--------|----------|----------------|-----------------------|
| 109038W | Black | 3/8" | 3/4 to 4" | 400 |
| 109012W | Black | 1/2" | 5" to 8" | 500 |
| 109038WG | Plated | 3/8" | 3/4 to 4" | 400 |
| 109012WG | Plated | 1/2" | 5" to 8" | 500 |

BEAM CLAMP - PURLIN



- Designed for use with large lip rolled steel purlins to eliminate the need to modify steel purlin for standard C-clamp
- Malleable iron with hardened steel cup point set screw

| PART# | FINISH | ROD SIZE | MAX. PIPE SIZE | MAX. REC. LOAD / LBS. |
|----------------|--------|----------|----------------|-----------------------|
| 109038P | Black | 3/8" | 4" | 400 |

BEAM CLAMP WRENCH



- A specially made ratchet wrench for easy installation of beam clamps

| PART# | DESCRIPTION |
|-------------|-------------------|
| 9955 | Beam clamp wrench |

HANGER SPECIALTIES

WOOD SCREWS



- Robertson (square) drive
- Plated
- 100 per box



| PART# | SIZE | LENGTH | PART# | SIZE | LENGTH |
|-------|------|--------|-------|------|--------|
| 1520 | #8 | 1/2" | 1531 | #10 | 1/2" |
| 1521 | #8 | 3/4" | 1532 | #10 | 3/4" |
| 1522 | #8 | 1" | 1533 | #10 | 1" |
| 1523 | #8 | 1-1/4" | 1534 | #10 | 1-1/4" |
| 1524 | #8 | 1-1/2" | 1535 | #10 | 1-1/2" |
| 1525 | #8 | 2" | 1536 | #10 | 2" |
| 1526 | #8 | 2-1/2" | 1537 | #10 | 2-1/2" |
| 1527 | #8 | 3" | 1538 | #10 | 3" |

LAG BOLTS



| PART# | DESCRIPTION | PART# | DESCRIPTION |
|---------|---------------|----------|---------------|
| 1099101 | 1/4" x 2" | 1099104 | 3/8" x 3" |
| 1099102 | 1/4" x 2-1/2" | 1099105 | 3/8" x 4" |
| 1099103 | 3/8" x 2" | 1099107A | 1/2" x 2-1/2" |
| 1099107 | 3/8" x 2-1/2" | 1099108 | 1/2" x 4" |

SHEET METAL SCREWS



- Robertson (square) drive
- Plated
- 100 per box



| PART# | SIZE | LENGTH | PART# | SIZE | LENGTH |
|-------|------|--------|-------|------|--------|
| 1817 | # 8 | 1/2" | 1821 | # 8 | 1" |
| 1819 | # 8 | 3/4" | 1871 | # 10 | 3/4" |

STOVE BOLT



- Round head with hex nuts
- 100 bolts and nuts per box

| PART# | SIZE | PART# | SIZE |
|-------|----------------|-------|---------------|
| 1635 | 3/16" x 3/4" | 1641 | 1/4" x 1" |
| 1637 | 3/16" x 1-1/4" | 1642 | 1/4" x 1-1/4" |
| 1639 | 1/4" x 1/2" | 1643 | 1/4" x 1-1/2" |
| 1640 | 1/4" x 3/4" | 1644 | 1/4" x 2" |

SELF DRILLING SHEET METAL SCREWS



- Robertson (square) drive
- Self drilling point plated
- 100 per box



| PART# | SIZE | LENGTH |
|-------|------|--------|
| 1830 | # 8 | 1/2" |
| 1831 | # 10 | 1-1/2" |
| 1832 | # 10 | 2" |

HANGER SPECIALTIES

SELF NAILING PROTECTION PLATE



- 100 per box

| PART# | SIZE | UNCOATED |
|-------------|---------|----------|
| 1628 | 2" x 5" | 20 |
| 1630 | 2" x 5" | 16 |

HANGER - PIPE STRAPS



- Galvanized

| PART# | IPS SIZE | PART# | IPS SIZE |
|-------------|----------|-------------|----------|
| 1614 | 1/2" | 1619 | 2" |
| 1615 | 3/4" | 1620 | 2-1/4" |
| 1616 | 1" | 1621 | 3" |
| 1617 | 1-1/4" | 1622 | 4" |
| 1618 | 1-1/2" | | |

HANGER - WIRE PIPE HOOKS



- 50 per box

- Uncoated

| PART# | SIZE | PART# | SIZE |
|-------------|-----------|-------------|------------|
| 1560 | 1/2" x 4" | 1566 | 3/4" x 8" |
| 1561 | 1/2" x 6" | 1567 | 3/4" x 10" |
| 1564 | 3/4" x 4" | 1569 | 1" x 6" |
| 1565 | 3/4" x 6" | | |

CABLE TIES



- Nylon cable ties can be used in countless applications and are adaptable to any environment and can be used both inside and outdoors

- UV protected, black colour

| PART# | COLOUR | SIZE | PART# | COLOUR | SIZE |
|-------------|--------|--------|--------------|--------|--------|
| 877 | Black | 7-1/2" | 8721 | Black | 21" |
| 8711 | Black | 11" | 877W | white | 7-1/2" |
| 8714 | Black | 14" | 8711W | white | 11" |

ANCHOR KIT



EACH SET CONTAINS:

- 100 #8-10 collar anchors
- 100 #10 x 1" Phillips with Hex head screws
- 1/4" Carbide tipped masonry drill
- Transparent, reusable box
- Phillips hex head screws allow a nutdriver, nut setter or screwdriver to be used

| PART# | DESCRIPTION |
|-------------|-------------|
| 1600 | Anchor kit |

HANGERS & FITTINGS

HANGER SPECIALTIES

ANGLE BRACKET



- For attachments to wood or steel beams, 2" x 1/2" bracket
- Hole to clear threaded rod

PART# SIZE

| | |
|-----------------|------|
| 10990638 | 3/8" |
| 10990639 | 1/2" |

BELL HANGERS



PART# SIZE

| | |
|---------------|------|
| 108112 | 1/2" |
| 108134 | 3/4" |
| 108110 | 1" |

TIE BOLT



- Tie bolt
- 3/4" x 4 1/2"
- For watermain service *Nut not included

PART# DESCRIPTION

| | |
|-----------------|---------------|
| 10991801 | Tie bolt only |
|-----------------|---------------|

HANGER INSERT NUT



- Insert nuts plated for ring hangers

PART# SIZE

| | |
|-----------------|------|
| 10992101 | 3/8" |
| 10992102 | 1/2" |

TOGGLE WING



- Toggle wing for 3/8" rod

PART# DESCRIPTION

| | |
|-----------------|-------------|
| 10992001 | Toggle wing |
|-----------------|-------------|

ROD COUPLING



- LYNCAR offers plated rod coupling in different sizes

PART# SIZE

| | |
|----------------|---------------|
| 1099081 | 3/8" x 1-3/4" |
| 1099082 | 3/8" x 1-1/4" |
| 1099083 | 1/2" x 1-3/4" |
| 1099084 | 5/8 x 2-1/4" |
| 1099085 | 3/4" x 2-1/4" |

ROD BUTTON



- Plastic rod button for 3/8 rod
- Use in wood construction
- White finish

PART# DESCRIPTION

| | |
|---------------|------------|
| 109901 | Rod button |
|---------------|------------|

DECK FLANGE

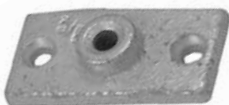

- Cast ceiling deck flange to support threaded rod 3/8" or 1/2" rod size

PART# SIZE

| | |
|------------------|-------------|
| 1099091MG | 3/8" plated |
| 1099092MG | 1/2" plated |

HANGER SPECIALTIES

MALLEABLE EYE SOCKET



- Available for 3/8" or 1/2" rod
- Use when swivel action is required

| PART# | SIZE |
|-----------------|------|
| 10991901 | 3/8" |
| 10991902 | 1/2" |

EYE SOCKET



- Steel eye sockets for 3/8" or 1/2" threaded rod
- Straight or offset models
- 100 per box
- FM and cULus approved



| PART# | SIZE |
|-----------------|-------------|
| 10990338 | 3/8" |
| 10990312 | 1/2" |
| 10990438 | 3/8" offset |

SIDE BEAM CONNECTOR, STEEL



- Threaded for 3/8" rod
- Used in wood or steel construction
- 2" max pipe size
- cULus approved



| PART# | DESCRIPTION |
|-----------------|---------------------|
| 10990538 | Side beam connector |

SIDE BEAM CONNECTOR, MALLEABLE



| PART# | DESCRIPTION |
|------------------|---------------------|
| 10990538M | Side beam connector |

DROP IN CONCRETE ANCHORS



| PART# | SIZE |
|-------------|-------------------------|
| 1557 | 3/8" mini , 100 per box |
| 1558 | 3/8", 50 per box |
| 1559 | 1/2", 50 per box |

ANCHOR SETTING TOOL



| PART# | SIZE |
|---------------|--------------|
| 1552 | 3/8" or 1/2" |
| 155212 | 1/2" |

HANGERS & FITTINGS

HANGER SPECIALTIES

PIPE STAYS - STANDARD

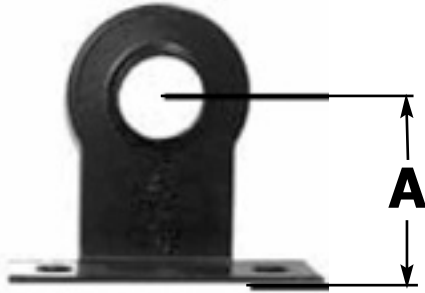

Standard

- LYNCAR's pipe stays are made of carbon steel & epoxy coated
- Used in water, heat & gas line. Copper & iron pipe sizes

| PART# | COPPER | IPS | "A" |
|-------|--------|--------|----------|
| 99400 | 1/2" | 3/8" | 1-7/16" |
| 99401 | 3/4" | 1/2" | 1-7/16" |
| 99402 | 1" | 3/4" | 1-5/8" |
| 99403 | 1-1/4" | 1" | 1-5/8" |
| 99404 | NA | 1-1/2" | 2-13/16" |
| 99405 | 1-1/2" | 1-1/4" | 2-1/2" |
| 99406 | NA | 2" | 2-15/16" |
| 99407 | 2" | NA | 2-13/16" |

PIPE STAYS - EXTENDED AND DOUBLE

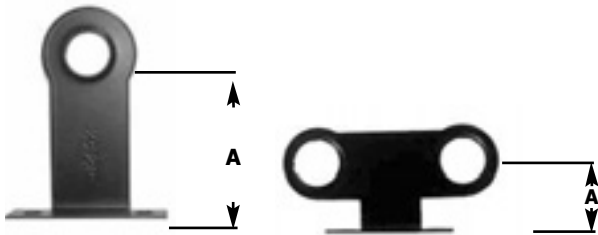

Extended

Double

| PART# | COPPER | IPS | "A" | DESCRIPTION |
|-------|--------|------|---------|-------------|
| 99410 | 1/2" | 3/8" | 2-1/2" | Extended |
| 99411 | 3/4" | 1/2" | 2-1/2" | Extended |
| 99412 | 1" | 3/4" | 2-3/4" | Extended |
| 99413 | 1-1/4" | 1" | 2-3/4" | Extended |
| 99415 | 1/2" | 3/8" | 1-7/16" | Double |
| 99416 | 3/4" | 1/2" | 1-7/16" | Double |
| 99417 | 1" | 3/4" | 1-5/8" | Double |

SPLIT RING HANGER

- LYNCAR's split ring hangers are available from 1/2" to 2" and in 2 screw, or hinged type.



2 SCREW SPLIT RING HANGER



HINGED SPLIT RING HANGER

| PART# | PIPE SIZE | DESCRIPTION |
|----------|-----------|-------------|
| 1092038 | 3/8" | 2 screw |
| 1092012 | 1/2" | 2 screw |
| 1092034 | 3/4" | 2 screw |
| 1092100 | 1" | 2 screw |
| 1092114 | 1 1/4" | 2 screw |
| 1092112 | 1 1/2" | 2 screw |
| 1092200 | 2" | 2 screw |
| 1092038H | 3/8" | Hinged |
| 1092012H | 1/2" | Hinged |
| 1092034H | 3/4" | Hinged |
| 1092100H | 1" | Hinged |
| 1092114H | 1 1/4" | Hinged |
| 1092112H | 1 1/2" | Hinged |
| 1092200H | 2" | Hinged |

HANGER SPECIALTIES

SPRINKLER RING HANGER



- Available to 8" IPS
- Available Galvanized & PVC coated
- Sold in box quantities only
- LYNCAR'S sprinkler hangers are UL, FM, ULC approved



| PART# | PIPE SIZE | DESCRIPTION |
|-----------|-----------|-------------|
| 1091012 | 1/2" | PLATED |
| 1091034 | 3/4" | PLATED |
| 1091100 | 1" | PLATED |
| 1091114 | 1 1/4" | PLATED |
| 1091112 | 1 1/2" | PLATED |
| 1091200 | 2" | PLATED |
| 1091212 | 2 1/2" | PLATED |
| 1091300 | 3" | PLATED |
| 1091400 | 4" | PLATED |
| 1091500 | 5" | PLATED |
| 1091600 | 6" | PLATED |
| 1091800 | 8" | PLATED |
| 1091012PC | 1/2" | PVC |
| 1091034PC | 3/4" | PVC |
| 1091100PC | 1" | PVC |
| 1091114PC | 1 1/4" | PVC |
| 1091112PC | 1 1/2" | PVC |
| 1091200PC | 2" | PVC |
| 1091212PC | 2 1/2" | PVC |
| 1091300PC | 3" | PVC |
| 1091400PC | 4" | PVC |

HANGER - J-HOOK™ PLASTIC PIPE



Faster Installation - Versatile Placement

- An exceptional hanger that saves time & money
- Assures greater accuracy in hanging, eliminates problems due to improper grades or movement after installation
- Eliminates measuring, adjusting, cutting & wrapping straps
- Hugs pipes snug & secure at easily determined grades
- Calibrated for 1/8" fall per foot (supported every 4 feet)
- Glueable with same adhesive used for pipe fittings
- 3" hook fits both Sch 30 and Sch 40 pipe
- Snap-in lock feature holds pipe securely, Nails included
- Use vertically or horizontally

| PART# | SIZE |
|-------|-------------|
| 20053 | 1-1/2" x 7" |
| 20054 | 2" x 7" |
| 20055 | 3" x 7" |
| 20056 | 4" x 7" |

SAMMY SCREWS

SAMMY X-PRESS SYSTEM INSTALLATION TOOLS



The SAMMY X-PRESS™ system is designed to provide direct attachment of threaded rod in metal deck (22-16 gauge) and thin gauge purlin (18-16 gauge), while providing reduced installation costs in terms of time and materials.

The X-PRESS anchors eliminate the need for costly “armovers” in pipe hanging installations. Current methods offered for thin gauge purlin require use of a time-consuming retaining nut on the threaded portion of the fastener to prevent pullout and are not designed for use in metal deck. In many instances, access to the backside of the installed fastener is prohibited by panel liner or roofing insulation. SAMMY X-PRESS anchors deliver the performance installers require without the use of a retaining nut!



The patent-pending X-PRESS anchors consist of a threaded fastener and expandable sleeve. The X-PRESS system features an easy-to-install anchor with expanding anchoring strips that collapse to prevent pullout after installation.



uninstalled

installed

The XP 20 provides 750 pounds of pullout in 22-20 gauge metal deck and will support a 2” pipe. The XP 35 delivers 1250 pounds of pullout in 18-16 gauge purlin and supports a 3-1/2” pipe.

| PART# | DESCRIPTION |
|----------|---------------------------|
| 1089XP20 | Support up to 2” pipe |
| 1089XP35 | Support up to 3-1/2” pipe |

SAMMY X-PRESS IT INSTALLATION TOOL



The SAMMY X-PRESS It™ Installation Tool assures a perfect installation every time offering the added convenience of one-tool efficiency, just drill and drive in SECONDS!

| PART# | DESCRIPTION |
|---------|---|
| 109914 | SAMMY straight screw installation tool |
| 109914S | SAMMY sidewinder screw installation tool |
| 109915 | SDS bit for Hilti™ drill (use with concrete SAMMYS) |
| 109916 | Sleeve tool (Tapcon method) |
| 1089XPT | X-PRESS It™ installation tool |
| 1089XPD | X-PRESS It™ drill bit 25/64 |

SAMMY SCREWS

SAMMY SCREWS FOR STEEL VERTICAL MOUNT

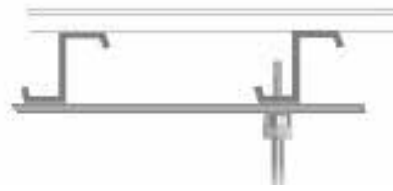

- Use Driver 109914
- Rod size is 3/8"

| PART# | MODEL TYPE | SELF DRILLING / SELF TAPPING | SIZE | UL | FM |
|----------------|------------|------------------------------|----------------|----|----|
| 1089303 | DST-10 | In steel to .188" | 1/4" x 1" | | |
| 1089301 | DST-15 | In steel to .188" | 1/4" x 1-1/2" | | |
| 1089300 | DST-30 | In steel to .188" | 1/4" x 3" | | |
| 1089202 | DSTR 1 | In steel to .188" | 1/4" x 1" | X | X |
| 1089203 | DSTR 1-1/2 | In steel to .188" | #12 x 1-1/2" | X | X |
| 1086303 | DSTR-516 | In steel to .188" | 5/16" x 1-1/4" | X | X |
| 1089305 | DST-516 | In steel to .188" | 5/16" x 1-1/4" | X | X |
| 1089200 | TEK-50 | In steel to .50" | #12 x 1-1/2" | X | X |



SAMMY SCREWS FOR STEEL HORIZONTAL MOUNT



- Use Driver 109914S
- Rod size is 3/8"

| PART# | MODEL TYPE | SELF DRILLING/SELF TAPPING | SIZE | UL | FM |
|----------------|------------|----------------------------|----------------|----|----|
| 1086301 | SWDR 1 | In steel to 1/4" | 1/4" x 1" | X | X |
| 1089307 | SWT 15 | In steel to 1/2" | #12 x 1-1/2" | | |
| 1089306 | SWDR-516 | In steel to 1/2" | 5/16" x 1-1/4" | X | X |
| 1089309 | SWDR 1-1/2 | In steel to 1/2" | #12 x 1-1/2" | X | X |

SAMMY SCREWS FOR STEEL SWIVEL MOUNT



- Use Driver 109914
- Rod size is 3/8"

| PART# | MODEL TYPE | USAGE | SIZE |
|-----------------|------------|------------------------|-----------|
| 1089303S | SH-DSTR 1 | Self drilling in steel | 1/4" x 1" |

HANGERS & FITTINGS

SAMMY SCREWS

SAMMY SCREWS FOR WOOD VERTICAL MOUNT

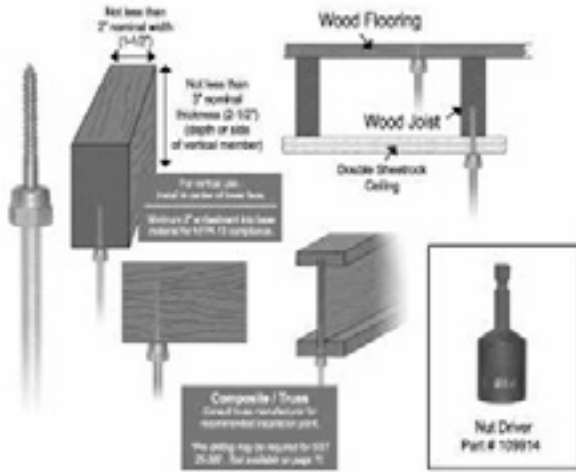

- Self threading in wood
- Rod size is 3/8"

| PART# | MODEL TYPE | SIZE |
|---------|------------|---------------|
| 1088200 | GST-20 | 1/4" x 2" |
| 1088300 | GST-30 | 1/4" x 3" |
| 1088380 | GST-25-380 | 3/8" x 2-1/2" |

SAMMY SCREWS FOR WOOD HORIZONTAL MOUNT

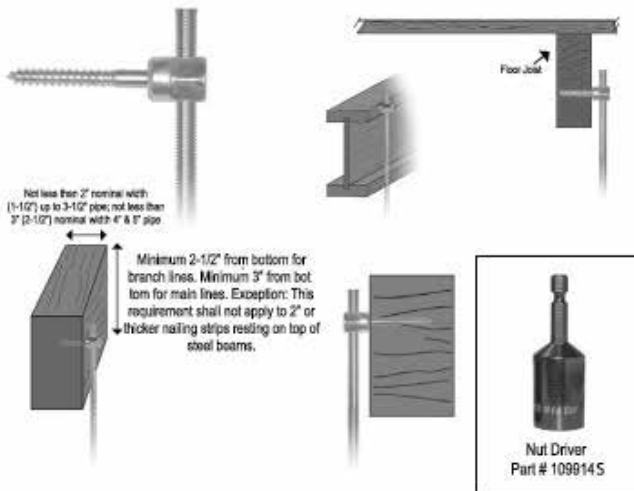

- Self threading in wood
- Rod size is 3/8"

| PART# | MODEL TYPE | SIZE |
|---------|------------|---------------|
| 1086302 | SWG10 | 1/4" x 1" |
| 1089302 | SWG20 | 1/4" x 2" |
| 1089380 | SWG-25-380 | 3/8" x 2-1/2" |

SAMMY SCREWS FOR WOOD SWIVEL MOUNT

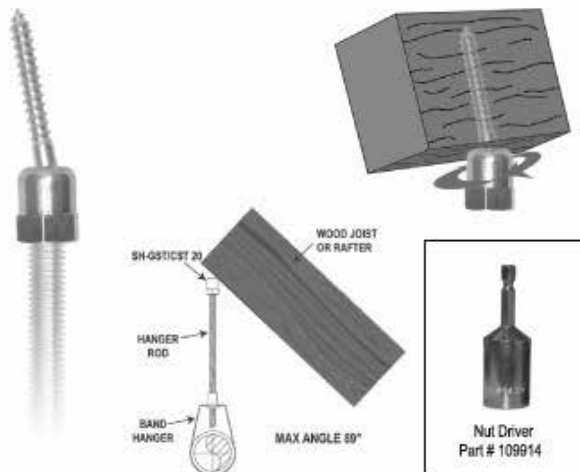

- Use Driver 109914
- Allows rod to hang plumb, No need to bend rod
- Deflection from vertical = 17°
- Accommodates 3-1/2" by 12" pitch roof
- Self threading in wood
- Rod size is 3/8"

| PART# | MODEL TYPE | SIZE |
|----------|------------|-----------|
| 1088200S | SH-GST 20 | 1/4" x 2" |
| 1088300S | SH-GST 30 | 1/4" x 3" |

SAMMY SCREWS

SAMMY SCREWS FOR DRYWALL VERTICAL MOUNT

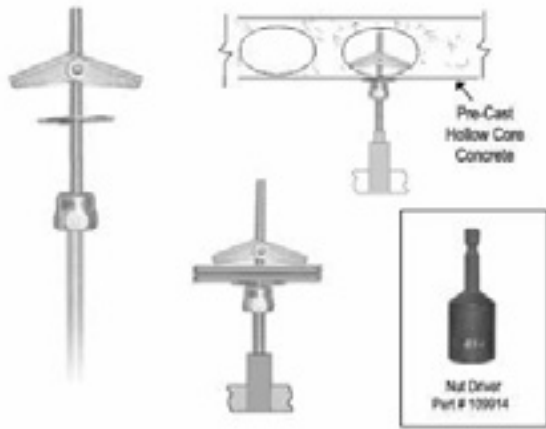

- Use driver 109914
- Rod size is 3/8"

| PART# | MODEL TYPE | SIZE |
|----------------|------------|-----------|
| 1086300 | SST-30 | 1/4" x 3" |

SAMMY SCREWS FOR CONCRETE VERTICAL MOUNT

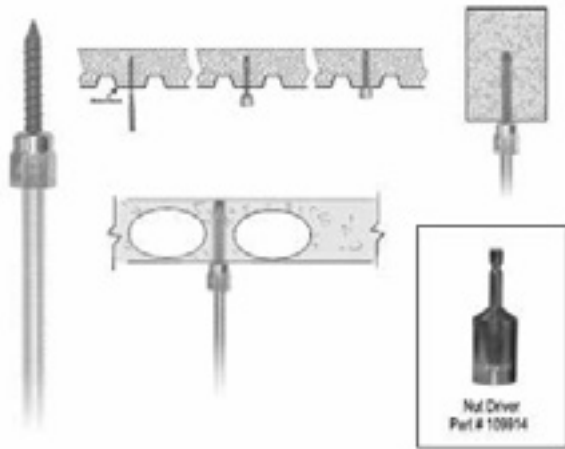

- Self tapping for concrete, pre-drilling
- Rod size is 3/8"

| PART# | MODEL TYPE | SIZE |
|----------------|------------|----------------|
| 1087134 | CST-20 | 5/16" x 1-3/4" |

SAMMY SCREWS FOR CONCRETE HORIZONTAL MOUNT

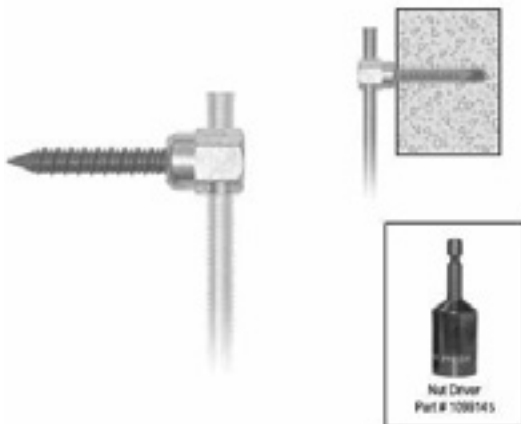

- Use driver part# 109914S
- Self tapping for concrete, pre-drilling
- Rod size is 3/8"

| PART# | MODEL TYPE | SIZE |
|----------------|------------|----------------|
| 1089304 | SWC-20 | 5/16" x 1-3/4" |

FITTINGS & COUPLINGS, BRASS

COUPLING - REDUCING, BRASS



| PART# | SIZE | PART# | SIZE | PART# | SIZE |
|-------|-------------|-------|-----------------|-------|-----------------|
| 7118 | 1/4" x 1/8" | 7132 | 1" x 1/4" | 7145 | 2" x 3/4" |
| 7119 | 3/8" x 1/4" | 7134 | 1-1/4" x 1" | 7146 | 2" x 1/2" |
| 7120 | 3/8" x 1/8" | 7135 | 1-1/4" x 3/4" | 7147 | 2-1/2" x 2" |
| 7123 | 1/2" x 3/8" | 7136 | 1-1/4" x 1/2" | 7148 | 2-1/2" x 1-1/2" |
| 7124 | 1/2" x 1/4" | 7137 | 1-1/4" x 3/8" | 7149 | 2-1/2" x 1-1/4" |
| 7125 | 1/2" x 1/8" | 7138 | 1-1/2" x 1-1/4" | 7150 | 2-1/2" x 1" |
| 7126 | 3/4" x 1/2" | 7139 | 1-1/2" x 1" | 7151 | 3" x 2-1/2" |
| 7127 | 3/4" x 3/8" | 7140 | 1-1/2" x 3/4" | 7152 | 3" x 2" |
| 7128 | 3/4" x 1/4" | 7141 | 1-1/2" x 1/2" | 7153 | 3" x 1-1/2" |
| 7129 | 1" x 3/4" | 7142 | 2" x 1-1/2" | 7156 | 4" x 3" |
| 7130 | 1" x 1/2" | 7143 | 2" x 1-1/4" | 7157 | 4" x 2-1/2" |
| 7131 | 1" x 3/8" | 7144 | 2" x 1" | 7158 | 4" x 2" |

COUPLING PIPE, BRASS



| PART# | SIZE |
|-------|--------|
| 7100 | 1/8" |
| 7101 | 1/4" |
| 7102 | 3/8" |
| 7103 | 1/2" |
| 7104 | 3/4" |
| 7105 | 1" |
| 7106 | 1-1/4" |
| 7107 | 1-1/2" |
| 7108 | 2" |
| 7109 | 2-1/2" |
| 7110 | 3" |
| 7112 | 4" |

UNION PIPE, BRASS



| PART# | SIZE |
|-------|--------|
| 7162 | 1/8" |
| 7163 | 1/4" |
| 7164 | 3/8" |
| 7165 | 1/2" |
| 7166 | 3/4" |
| 7167 | 1" |
| 7168 | 1-1/4" |
| 7169 | 1-1/2" |
| 7170 | 2" |
| 7171 | 2-1/2" |
| 7172 | 3" |
| 7173 | 4" |

ELBOW 45°, BRASS



| PART# | SIZE |
|-------|--------|
| 7174 | 1/8" |
| 7175 | 1/4" |
| 7176 | 3/8" |
| 7177 | 1/2" |
| 7178 | 3/4" |
| 7179 | 1" |
| 7180 | 1-1/4" |
| 7181 | 1-1/2" |
| 7182 | 2" |
| 7183 | 2-1/2" |
| 7184 | 3" |
| 7185 | 4" |

ELBOW 45° STREET, BRASS



| PART# | SIZE |
|-------|--------|
| 7189 | 1/8" |
| 7190 | 1/4" |
| 7191 | 3/8" |
| 7192 | 1/2" |
| 7193 | 3/4" |
| 7194 | 1" |
| 7195 | 1-1/4" |
| 7196 | 1-1/2" |
| 7197 | 2" |
| 7198 | 2-1/2" |
| 7199 | 3" |
| 7200 | 4" |

ELBOW 90°, BRASS



| PART# | SIZE |
|-------|--------|
| 7204 | 1/8" |
| 7205 | 1/4" |
| 7206 | 3/8" |
| 7207 | 1/2" |
| 7208 | 3/4" |
| 7209 | 1" |
| 7210 | 1-1/4" |
| 7211 | 1-1/2" |
| 7212 | 2" |
| 7213 | 2-1/2" |
| 7214 | 3" |
| 7216 | 4" |

ELBOW 90° STREET, BRASS



| PART# | SIZE |
|-------|--------|
| 7247 | 1/8" |
| 7248 | 1/4" |
| 7249 | 3/8" |
| 7250 | 1/2" |
| 7251 | 3/4" |
| 7252 | 1" |
| 7253 | 1-1/4" |
| 7254 | 1-1/2" |
| 7255 | 2" |
| 7256 | 2-1/2" |
| 7257 | 3" |
| 7258 | 4" |

FITTINGS & COUPLINGS, BRASS

**ELBOW
90° REDUCING,
BRASS**



| PART# | SIZE | PART# | SIZE | PART# | SIZE |
|-------|-------------|-------|-----------------|-------|-------------|
| 7220 | 1/4" x 1/8" | 7231 | 1" x 3/8" | 7243 | 2-1/2" x 2" |
| 7221 | 3/8" x 1/4" | 7232 | 1-1/4" x 1" | 7244 | 3" x 2" |
| 7222 | 3/8" x 1/8" | 7233 | 1-1/4" x 3/4" | 7245 | 3" x 2-1/2" |
| 7223 | 1/2" x 3/8" | 7234 | 1-1/4" x 1/2" | 7246 | 4" x 3" |
| 7224 | 1/2" x 1/4" | 7236 | 1-1/2" x 1-1/4" | | |
| 7225 | 1/2" x 1/8" | 7237 | 1/2"1-1/2"x 1" | | |
| 7226 | 3/4" x 1/2" | 7238 | 1-1/2" x 3/4" | | |
| 7227 | 3/4" x 3/8" | 7239 | 2" x 1-1/2" | | |
| 7228 | 3/4" x 1/4" | 7240 | 2" x 1-1/4" | | |
| 7229 | 1" x 3/4" | 7241 | 2" x 1" | | |
| 7230 | 1" x 1/2" | 7242 | 2" x 3/4" | | |

**TEE - PIPE,
BRASS**



Threaded - 125 Pound.
LYNCAR Cast Brass Fittings
meet ANSI B16.15 - 1978
Specification for 125 Pound
Thread Fittings

| PART# | SIZE |
|-------|--------|
| 7259 | 1/8" |
| 7260 | 1/4" |
| 7261 | 3/8" |
| 7262 | 1/2" |
| 7263 | 3/4" |
| 7264 | 1" |
| 7265 | 1-1/4" |
| 7266 | 1-1/2" |
| 7267 | 2" |
| 7268 | 2-1/2" |
| 7269 | 3" |
| 7270 | 3-1/2" |
| 7271 | 4" |

**CAP
BRASS**



| PART# | SIZE |
|-------|--------|
| 7404 | 1/8" |
| 7405 | 1/4" |
| 7406 | 3/8" |
| 7407 | 1/2" |
| 7408 | 3/4" |
| 7409 | 1" |
| 7410 | 1-1/4" |
| 7411 | 1-1/2" |
| 7412 | 2" |
| 7413 | 2-1/2" |
| 7414 | 3" |
| 7416 | 4" |

**CROSSES PIPE,
BRASS**



| PART# | SIZE |
|-------|--------|
| 7500 | 1/8" |
| 7501 | 1/4" |
| 7502 | 3/8" |
| 7503 | 1/2" |
| 7504 | 3/4" |
| 7505 | 1" |
| 7506 | 1-1/4" |
| 7507 | 1-1/2" |
| 7508 | 2" |

**FLOOR FLANGES,
BRASS**



| PART# | SIZE |
|-------|--------|
| 7538 | 1/2" |
| 7539 | 3/4" |
| 7540 | 1" |
| 7541 | 1-1/4" |
| 7542 | 1-1/2" |

**EXTENSION
PIECES, BRASS**



| PART# | SIZE |
|-------|--------|
| 7524 | 1/8" |
| 7525 | 1/4" |
| 7526 | 3/8" |
| 7527 | 1/2" |
| 7528 | 3/4" |
| 7529 | 1" |
| 7530 | 1-1/4" |
| 7531 | 1-1/2" |
| 7532 | 2" |

**LOCKNUTS
BRASS, BRASS**

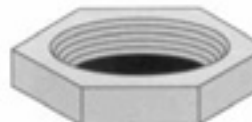

| PART# | SIZE |
|-------|--------|
| 7561 | 1/8" |
| 7562 | 1/4" |
| 7563 | 3/8" |
| 7564 | 1/2" |
| 7565 | 3/4" |
| 7566 | 1" |
| 7567 | 1-1/4" |
| 7568 | 1-1/2" |
| 7569 | 2" |

FITTINGS & COUPLINGS, BRASS

REDUCING TEES, BRASS



| PART# | SIZE | PART# | SIZE | PART# | SIZE |
|-------|--------------------|-------|--------------------------|-------|--------------------------|
| 7283 | 3/8" x 3/8" x 1/4" | 7320 | 1" x 3/4" x 3/4" | 7368 | 2" x 2" x 1/2" |
| 7292 | 1/2" x 1/2" x 3/4" | 7321 | 1" x 3/4" x 1/2" | 7381 | 2-1/2" x 2-1/2" x 2" |
| 7293 | 1/2" x 1/2" x 3/8" | 7323 | 1" x 1/2" x 1" | 7382 | 2-1/2" x 2-1/2" x 1-1/2" |
| 7294 | 1/2" x 1/2" x 1/4" | 7324 | 1" x 1/2" x 3/4" | 7384 | 2-1/2" x 2-1/2" x 1" |
| 7295 | 1/2" x 1/2" x 1/8" | 7325 | 1" x 1/2" x 1/2" | 7386 | 2-1/2" x 2-1/2" x 1/2" |
| 7299 | 1/2" x 1/4" x 1/2" | 7326 | 1" x 1/2" x 3/8" | 7388 | 3" x 3" x 2-1/2" |
| 7302 | 3/4" x 3/4" x 1" | 7328 | 1-1/4" x 1-1/4" x 1" | 7389 | 3" x 3" x 2" |
| 7303 | 3/4" x 3/4" x 1/2" | 7329 | 1-1/4" x 1-1/4" x 3/4" | 7390 | 3" x 3" x 1-1/2" |
| 7304 | 3/4" x 3/4" x 3/8" | 7330 | 1-1/4" x 1-1/4" x 1/2" | 7391 | 3" x 3" x 1-1/4" |
| 7305 | 3/4" x 3/4" x 1/4" | 7333 | 1-1/4" x 1" x 1" | 7392 | 3" x 3" x 1" |
| 7306 | 3/4" x 3/4" x 1/8" | 7342 | 1-1/2" x 1-1/2" x 1-1/4" | 7393 | 3" x 3" x 3/4" |
| 7307 | 3/4" x 1/2" x 3/4" | 7343 | 1-1/2" x 1-1/2" x 1" | 7394 | 3" x 3" x 1/2" |
| 7308 | 3/4" x 1/2" x 1/2" | 7344 | 1-1/2" x 1-1/2" x 3/4" | 7395 | 4" x 4" x 3" |
| 7313 | 1" x 1" x 1-1/2" | 7345 | 1-1/2" x 1-1/2" x 1/2" | 7396 | 4" x 4" x 2-1/2" |
| 7315 | 1" x 1" x 3/4" | 7346 | 2" x 2" x 1-1/2" | 7397 | 4" x 4" x 2" |
| 7316 | 1" x 1" x 1/2" | 7365 | 2" x 2" x 1-1/4" | 7398 | 4" x 4" x 1-1/2" |
| 7317 | 1" x 1" x 3/8" | 7366 | 2" x 2" x 1" | | |
| 7319 | 1" x 3/4" x 1" | 7367 | 2" x 2" x 3/4" | | |

BUSHING - HEX BRONZE, BRASS



| PART# | SIZE | PART# | SIZE | PART# | SIZE |
|-------|-------------|-------|-----------------|-------|-----------------|
| 7436 | 1/4" x 1/8" | 7452 | 1-1/4" x 3/4" | 7468 | 2" x 1/2" |
| 7437 | 3/8" x 1/4" | 7453 | 1-1/4" x 1/2" | 7472 | 2-1/2" x 2" |
| 7438 | 3/8" x 1/8" | 7454 | 1-1/4" x 3/8" | 7473 | 2-1/2" x 1-1/2" |
| 7439 | 1/2" x 3/8" | 7455 | 1-1/4" x 1/4" | 7474 | 2-1/2" x 1-1/4" |
| 7440 | 1/2" x 1/4" | 7456 | 1-1/4" x 1/8" | 7475 | 2-1/2" x 1" |
| 7441 | 1/2" x 1/8" | 7457 | 1-1/2" x 1-1/4" | 7481 | 3" x 2-1/2" |
| 7442 | 3/4" x 1/2" | 7458 | 1-1/2" x 1" | 7482 | 3" x 2" |
| 7443 | 3/4" x 3/8" | 7459 | 1-1/2" x 3/4" | 7483 | 3" x 1-1/2" |
| 7444 | 3/4" x 1/4" | 7460 | 1-1/2" x 1/2" | 7484 | 3" x 1-1/4" |
| 7445 | 3/4" x 1/8" | 7461 | 1-1/2" x 3/8" | 7485 | 3" x 1" |
| 7446 | 1" x 3/4" | 7462 | 1-1/2" x 1/4" | 7486 | 3" x 3/4" |
| 7447 | 1" x 1/2" | 7463 | 1-1/2" x 1/8" | 7487 | 3" x 1/2" |
| 7448 | 1" x 3/8" | 7464 | 2" x 1-1/2" | 7489 | 4" x 3" |
| 7449 | 1" x 1/4" | 7465 | 2" x 1-1/4" | 7490 | 4" x 2-1/2" |
| 7450 | 1" x 1/8" | 7466 | 2" x 1" | 7491 | 4" x 2" |
| 7451 | 1-1/4" x 1" | 7467 | 2" x 3/4" | 7492 | 4" x 1-1/2" |

FITTINGS & COUPLINGS

TEE COUPLING - TEE BRASS



| PART# | CWT | IPS | NPT TEE OUTLET |
|-------|--------|--------|----------------|
| 2935 | 1/2" | 3/8" | 1/2" |
| 2936 | 3/4" | 1/2" | 3/4" |
| 2937 | 1" | 3/4" | 1" |
| 2938 | 3/4" | 1/2" | 1/2" |
| 2939 | 1" | 3/4" | 1/2" |
| 2940 | 1" | 3/4" | 3/4" |
| 2941 | 1-1/4" | 1" | 3/4" |
| 2942 | 1-1/4" | 1" | 1" |
| 2943 | 1-1/2" | 1-1/4" | 1-1/4" |
| 2944 | -- | 1-1/2" | 1-1/2" |
| 2945 | -- | 2" | 1-1/2" |
| 2946 | -- | 2" | 2" |

SQUARE HEAD PLUGS



| PART# | SIZE |
|-------|--------|
| 7420 | 1/8" |
| 7421 | 1/4" |
| 7422 | 3/8" |
| 7423 | 1/2" |
| 7424 | 3/4" |
| 7425 | 1" |
| 7426 | 1-1/4" |
| 7427 | 1-1/2" |
| 7428 | 2" |
| 7429 | 2-1/2" |
| 7430 | 3" |
| 7432 | 4" |

LONG COUPLING - IRON



| PART# | IPS | LENGTH |
|-------|--------|--------|
| 2908 | 1/2" | 3-3/4" |
| 2909 | 3/4" | 4" |
| 2910 | 1" | 4-1/4" |
| 2911 | 1-1/4" | 4-3/4" |
| 2912 | 1-1/2" | 5" |
| 2913 | 2" | 5-3/8" |

LONG COUPLING - BRASS



| PART# | CWT | IPS | LENGTH |
|-------|--------|--------|--------|
| 2921 | 1/2" | 3/8" | 5" |
| 2922 | 3/4" | 1/2" | 5" |
| 2923 | 1" | 3/4" | 5" |
| 2924 | 1-1/4" | 1" | 5" |
| 2925 | 1-1/2" | 1-1/4" | 5" |
| 2926 | 2" | -- | 5" |
| 2929 | -- | 1-1/2" | 5" |
| 2930 | -- | 2" | 5" |

TEE COUPLING - IRON



| PART# | IPS | BRANCH SIZE |
|-------|------|-------------|
| 2914 | 1/2" | 1/2" |
| 2915 | 3/4" | 3/4" |

MALE x COMPRESSION - IRON



| PART# | TUBE O.D. |
|-------|-----------|
| 2950 | 1/2" |
| 2951 | 3/4" |

SHORT COUPLING - IRON



| PART# | IPS | LENGTH |
|-------|--------|--------|
| 2900 | 1/2" | 2-5/8" |
| 2901 | 3/4" | 2-3/4" |
| 2902 | 1" | 3-1/8" |
| 2903 | 1-1/4" | 3-1/4" |
| 2904 | 1-1/2" | 3-3/8" |
| 2905 | 2" | 3-5/8" |
| 2906 | 2-1/2" | 4-3/8" |
| 2907 | 3" | 4-3/4" |

SHORT COUPLING - BRASS



| PART# | CWT | IPS | LENGTH |
|-------|--------|--------|---------|
| 2916 | 1/2" | 3/8" | 2-9/16" |
| 2917 | 3/4" | 1/2" | 2-3/4" |
| 2918 | 1" | 3/4" | 3" |
| 2919 | 1-1/4" | 1" | 3" |
| 2920 | 1-1/2" | 1-1/4" | 3-1/4" |
| 2927 | -- | 1-1/2" | 3-1/2" |

These couplings are intended for temporary repair. Do not use on hot water, steam, oxygen, petroleum or similar explosive or combustible mediums.

NIPPLES - BRASS

Each nipple is cleaned of burrs and cutting oil and manufactured in accordance with ASTM B-687. Sizes 1-1/4" through 4" continued on the next page.



1/8"

1/4"

3/8"

| PART# | LENGTH |
|-------|--------|
| 7700 | CL |
| 7701 | 1-1/2" |
| 7702 | 2" |
| 7703 | 2-1/2" |
| 7704 | 3" |
| 7705 | 3-1/2" |
| 7706 | 4" |
| 7707 | 4-1/2" |
| 7708 | 5" |
| 7709 | 5-1/2" |
| 7710 | 6" |

| PART# | LENGTH |
|-------|--------|
| 7717 | CL |
| 7718 | 1-1/2" |
| 7719 | 2" |
| 7720 | 2-1/2" |
| 7721 | 3" |
| 7722 | 3-1/2" |
| 7723 | 4" |
| 7724 | 4-1/2" |
| 7725 | 5" |
| 7726 | 5-1/2" |
| 7727 | 6" |

| PART# | LENGTH |
|-------|--------|
| 7734 | CL |
| 7735 | 1-1/2" |
| 7736 | 2" |
| 7737 | 2-1/2" |
| 7738 | 3" |
| 7739 | 3-1/2" |
| 7740 | 4" |
| 7741 | 4-1/2" |
| 7742 | 5" |
| 7743 | 5-1/2" |
| 7744 | 6" |

1/2"

3/4"

1"

| PART# | LENGTH |
|-------|--------|
| 7751 | CL |
| 7752 | 1-1/2" |
| 7753 | 2" |
| 7754 | 2-1/2" |
| 7755 | 3" |
| 7756 | 3-1/2" |
| 7757 | 4" |
| 7758 | 4-1/2" |
| 7759 | 5" |
| 7760 | 5-1/2" |
| 7761 | 6" |
| 7762 | 6-1/2" |
| 7763 | 8" |
| 7765 | 10" |
| 7767 | 12" |

| PART# | LENGTH |
|-------|--------|
| 7768 | CL |
| 7769 | 1-1/2" |
| 7770 | 2" |
| 7771 | 2-1/2" |
| 7772 | 3" |
| 7773 | 3-1/2" |
| 7774 | 4" |
| 7775 | 4-1/2" |
| 7776 | 5" |
| 7777 | 5-1/2" |
| 7778 | 6" |
| 7780 | 8" |
| 7782 | 10" |
| 7784 | 12" |

| PART# | LENGTH |
|-------|--------|
| 7785 | CL |
| 7786 | 2" |
| 7787 | 2-1/2" |
| 7789 | 3" |
| 7790 | 3-1/2" |
| 7791 | 4" |
| 7792 | 4-1/2" |
| 7793 | 5" |
| 7794 | 5-1/2" |
| 7795 | 6" |
| 7797 | 8" |
| 7799 | 10" |
| 7801 | 12" |

NIPPLES - BRASS

Each nipple is cleaned of burrs and cutting oil and manufactured in accordance with ASTM B-687.



1-1/4"

| PART# | LENGTH |
|-------|--------|
| 7802 | CL |
| 7803 | 2" |
| 7804 | 2-1/2" |
| 7805 | 3" |
| 7806 | 3-1/2" |
| 7807 | 4" |
| 7808 | 4-1/2" |
| 7809 | 5" |
| 7810 | 5-1/2" |
| 7811 | 6" |
| 7813 | 8" |
| 7815 | 10" |
| 7817 | 12" |

1-1/2"

| PART# | LENGTH |
|-------|--------|
| 7818 | CL |
| 7819 | 2" |
| 7820 | 2-1/2" |
| 7821 | 3" |
| 7822 | 3-1/2" |
| 7823 | 4" |
| 7824 | 4-1/2" |
| 7825 | 5" |
| 7826 | 5-1/2" |
| 7827 | 6" |
| 7829 | 8" |
| 7831 | 10" |
| 7833 | 12" |

2"

| PART# | LENGTH |
|-------|--------|
| 7834 | CL |
| 7835 | 2-1/2" |
| 7836 | 3" |
| 7837 | 3-1/2" |
| 7838 | 4" |
| 7839 | 4-1/2" |
| 7840 | 5" |
| 7841 | 5-1/2" |
| 7842 | 6" |
| 7844 | 8" |
| 7846 | 10" |
| 7848 | 12" |

2-1/2"

| PART# | LENGTH |
|-------|--------|
| 7849 | CL |
| 7850 | 3" |
| 7851 | 3-1/2" |
| 7852 | 4" |
| 7853 | 4-1/2" |
| 7854 | 5" |
| 7855 | 5-1/2" |
| 7856 | 6" |
| 7858 | 8" |
| 7860 | 10" |
| 7862 | 12" |

3"

| PART# | LENGTH |
|-------|--------|
| 7863 | CL |
| 7864 | 3" |
| 7865 | 3-1/2" |
| 7866 | 4" |
| 7867 | 4-1/2" |
| 7868 | 5" |
| 7869 | 5-1/2" |
| 7870 | 6" |
| 7872 | 8" |
| 7874 | 10" |
| 7876 | 12" |

4"

| PART# | LENGTH |
|-------|--------|
| 7888 | CL |
| 7889 | 4" |
| 7890 | 4-1/2" |
| 7891 | 5" |
| 7892 | 5-1/2" |
| 7893 | 6" |
| 7895 | 8" |
| 7897 | 10" |
| 7899 | 12" |

NIPPLE BOXES

NIPPLE BOXES



- Holds 1/2" CL thru 6" nipples
- Fold away handle
- Epoxy coated steel
- Light weight yet strong

| PART# | SIZE | HOLDS |
|-------------|--------|-------|
| 3080 | 1/2" | 77 |
| 3081 | 3/4" | 66 |
| 3082 | 1" | 50 |
| 3083 | 1-1/4" | 40 |
| 3084 | 1-1/2" | 30 |
| 3085 | 2" | 27 |

FITTING TOTE TRAY

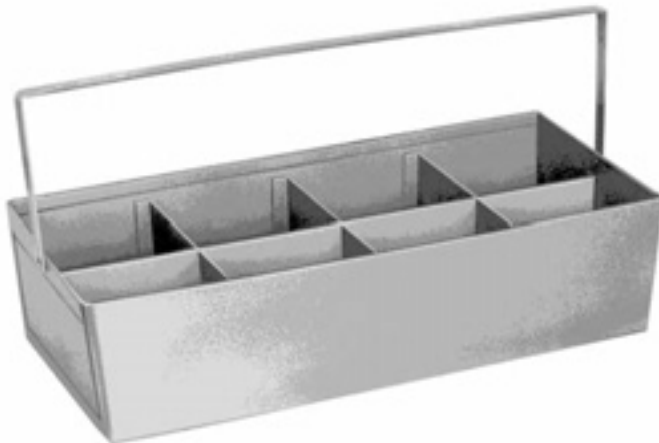

- Excellent for copper fittings
- 18 gauge
- 20" x 10" x 5"
- Fold away handle
- Epoxy coated steel
- With 8 compartments

| PART# | DESCRIPTION |
|-------------|-------------------|
| 3088 | Fitting tote tray |

NIPPLE BOX - 1/2" & 3/4" (COMBO)



- Holds both 1/2" and 3/4" nipples
- Holds (39) 1/2" CL thru 6"
- Holds (33) 3/4" CL thru 6"
- Fold away handle
- Epoxy coated steel

| PART# | DESCRIPTION |
|-------------|---------------|
| 3091 | 1/2" and 3/4" |

CHROME PLATED BRASS FITTINGS

CAP - CHROME



| PART# | SIZE | PART# | SIZE |
|-------|------|-------|--------|
| 7405C | 1/4" | 7409C | 1" |
| 7406C | 3/8" | 7410C | 1-1/4" |
| 7407C | 1/2" | 7411C | 1-1/2" |
| 7408C | 3/4" | 7412C | 2" |

COUPLING - PIPE CP



| PART# | SIZE |
|-------|--------|
| 7101C | 1/4" |
| 7102C | 3/8" |
| 7103C | 1/2" |
| 7104C | 3/4" |
| 7105C | 1" |
| 7106C | 1-1/4" |
| 7107C | 1-1/2" |
| 7108C | 2" |

ELBOW - 90° CP



| PART# | SIZE |
|-------|--------|
| 7205C | 1/4" |
| 7206C | 3/8" |
| 7207C | 1/2" |
| 7208C | 3/4" |
| 7209C | 1" |
| 7210C | 1-1/4" |
| 7211C | 1-1/2" |
| 7212C | 2" |

COUPLING - REDUCING



| PART# | SIZE |
|-------|-------------|
| 7123C | 1/2" x 3/8" |
| 7126C | 3/4" x 1/2" |

ELBOW - 90° REDUCING CP



| PART# | SIZE |
|-------|-------------|
| 7223C | 1/2" x 3/8" |
| 7226C | 3/4" x 1/2" |

UNION - PIPE CP



| PART# | SIZE |
|-------|--------|
| 7163C | 1/4" |
| 7164C | 3/8" |
| 7165C | 1/2" |
| 7166C | 3/4" |
| 7167C | 1" |
| 7168C | 1-1/4" |
| 7169C | 1-1/2" |
| 7170C | 2" |

ELBOW 90° STREET CP



| PART# | SIZE |
|-------|--------|
| 7248C | 1/4" |
| 7249C | 3/8" |
| 7250C | 1/2" |
| 7251C | 3/4" |
| 7252C | 1" |
| 7253C | 1-1/4" |
| 7254C | 1-1/2" |
| 7255C | 2" |

CHROME PLATED BRASS FITTINGS

ELBOW 45° CP



| PART# | SIZE |
|-------|--------|
| 7175C | 1/4" |
| 7176C | 3/8" |
| 7177C | 1/2" |
| 7178C | 3/4" |
| 7179C | 1" |
| 7180C | 1-1/4" |
| 7181C | 1-1/2" |
| 7182C | 2" |

TEE - PIPE CP



| PART# | SIZE |
|-------|--------|
| 7260C | 1/4" |
| 7261C | 3/8" |
| 7262C | 1/2" |
| 7263C | 3/4" |
| 7264C | 1" |
| 7265C | 1-1/4" |
| 7266C | 1-1/2" |
| 7267C | 2" |

ELBOW - 45° STREET CP



| PART# | SIZE |
|-------|------|
| 7192C | 1/2" |

REDUCING TEES CP

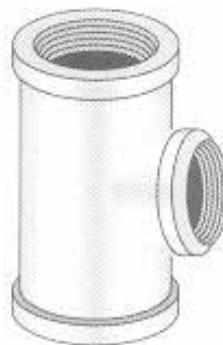

| PART# | SIZE |
|-------|-------------|
| 7203C | 3/4" x 1/2" |

PLUGS



| PART# | SIZE |
|-------|--------|
| 7421C | 1/4" |
| 7422C | 3/8" |
| 7423C | 1/2" |
| 7424C | 3/4" |
| 7425C | 1" |
| 7426C | 1-1/4" |
| 7427C | 1-1/2" |
| 7428C | 2" |

BUSHING - HEX CP



| PART# | SIZE |
|-------|-------------|
| 7437C | 3/8" x 1/4" |
| 7439C | 1/2" x 3/8" |
| 7440C | 1/2" x 1/4" |
| 7442C | 3/4" x 1/2" |
| 7446C | 1" x 3/4" |
| 7451C | 1-1/4" x 1" |

CHROME PLATED BRASS NIPPLES

CHROME PLATED BRASS NIPPLES



1/4"

3/8"

1/2"

3/4"

| PART# | LENGTH | PART# | LENGTH | PART# | LENGTH | PART# | LENGTH |
|-------|--------|-------|--------|-------|--------|-------|--------|
| 7717C | CL | 7734C | CL | 7751C | CL | 7768C | CL |
| 7718C | 1-1/2" | 7735C | 1-1/2" | 7752C | 1-1/2" | 7769C | 1-1/2" |
| 7719C | 2" | 7736C | 2" | 7753C | 2" | 7770C | 2" |
| 7720C | 2-1/2" | 7737C | 2-1/2" | 7754C | 2-1/2" | 7771C | 2-1/2" |
| 7721C | 3" | 7738C | 3" | 7755C | 3" | 7772C | 3" |
| 7722C | 3-1/2" | 7739C | 3-1/2" | 7756C | 3-1/2" | 7773C | 3-1/2" |
| 7723C | 4" | 7740C | 4" | 7757C | 4" | 7774C | 4" |
| 7724C | 4-1/2" | 7741C | 4-1/2" | 7758C | 4-1/2" | 7775C | 4-1/2" |
| 7725C | 5" | 7742C | 5" | 7759C | 5" | 7776C | 5" |
| 7726C | 5-1/2" | 7743C | 5-1/2" | 7760C | 5-1/2" | 7777C | 5-1/2" |
| 7727C | 6" | 7744C | 6" | 7761C | 6" | 7778C | 6" |

1"

1-1/4"

1-1/2"

2"

| PART# | LENGTH | PART# | LENGTH | PART# | LENGTH | PART# | LENGTH |
|-------|--------|-------|--------|-------|--------|-------|--------|
| 7785C | CL | 7802C | CL | 7818C | CL | 7834C | CL |
| 7786C | 2" | 7803C | 2" | 7819C | 2" | 7835C | 2-1/2" |
| 7787C | 2-1/2" | 7804C | 2-1/2" | 7820C | 2-1/2" | 7836C | 3" |
| 7789C | 3" | 7805C | 3" | 7821C | 3" | 7837C | 3-1/2" |
| 7790C | 3-1/2" | 7806C | 3-1/2" | 7822C | 3-1/2" | 7838C | 4" |
| 7791C | 4" | 7807C | 4" | 7823C | 4" | 7839C | 4-1/2" |
| 7792C | 4-1/2" | 7808C | 4-1/2" | 7824C | 4-1/2" | 7840C | 5" |
| 7793C | 5" | 7809C | 5" | 7825C | 5" | 7841C | 5-1/2" |
| 7794C | 5-1/2" | 7810C | 5-1/2" | 7826C | 5-1/2" | 7842C | 6" |
| 7795C | 6" | 7811C | 6" | 7827C | 6" | 7844C | 8" |
| 7797C | 8" | 7813C | 8" | 7829C | 8" | 7846C | 10" |
| 7799C | 10" | 7815C | 10" | 7831C | 10" | 7848C | 12" |
| 7801C | 12" | 7817C | 12" | 7833C | 12" | | |

HANGERS & FITTINGS

BRASS FLARE & COMPRESSION FITTINGS

FLARE - 39 SERIES PLUGS



| PART# | SIZE |
|-------|-------|
| 7-393 | 3/16" |
| 7-394 | 1/4" |
| 7-395 | 5/16" |
| 7-396 | 3/8" |
| 7-398 | 1/2" |

FLARE - 41SC SWIVEL VALVE CONNECT



| PART# | SIZE |
|---------|------|
| 7-41SC4 | 1/4" |
| 7-41SC6 | 3/8" |
| 7-41SC8 | 1/2" |

FLARE - 40 SERIES CAP NUTS



| PART# | SIZE |
|-------|-------|
| 7-403 | 3/16" |
| 7-404 | 1/4" |
| 7-405 | 5/16" |
| 7-406 | 3/8" |
| 7-408 | 1/2" |

FLARE - 41SHN SPACE HEATER NUT



9/16" X 24 Thread

| PART# | SIZE |
|---------|------|
| 7-41SHN | 3/8" |

FLARE - 41F SERIES - FORGED SHORT NUT



| PART# | SIZE |
|---------|-------|
| 7-41F3 | 3/16" |
| 7-41F4 | 1/4" |
| 7-41F5 | 5/16" |
| 7-41F6 | 3/8" |
| 7-41F8 | 1/2" |
| 7-41F10 | 5/8" |

FLARE - 41L SERIES LONG NUT



| PART# | SIZE |
|---------|-------------|
| 7-41L3 | 1/8" |
| 7-41L4 | 3/16" |
| 7-41L5 | 1/4" |
| 7-41L6 | 5/16" |
| 7-41L8 | 3/8" |
| 7-41L10 | 3/8" x 1/4" |

FLARE - 42 SERIES UNIONS



| PART# | SIZE |
|--------|-------------|
| 7-423 | 3/16" |
| 7-424 | 1/4" |
| 7-425 | 5/16" |
| 7-426 | 3/8" |
| 7-4264 | 3/8" x 1/4" |
| 7-428 | 1/2" |
| 7-4284 | 1/2" x 1/4" |
| 7-4286 | 1/2" x 3/8" |
| 7-4210 | 5/8" |

FLARE - 44 SERIES TEES



| PART# | SIZE |
|--------|-------------|
| 7-444 | 1/4" |
| 7-445 | 5/16" |
| 7-446 | 3/8" |
| 7-4464 | 3/8" x 1/4" |
| 7-4468 | 3/8" x 1/2" |
| 7-448 | 1/2" |
| 7-4484 | 1/2" x 1/4" |
| 7-4486 | 1/2" x 3/8" |
| 7-4410 | 5/8" |

BRASS FLARE & COMPRESSION FITTINGS

**FLARE - 41S SERIES
SHORT NUT**



| PART# | SIZE |
|---------|-------------|
| 7-41S2 | 1/8" |
| 7-41S3 | 3/16" |
| 7-41S4 | 1/4" |
| 7-41S5 | 5/16" |
| 7-41S6 | 3/8" |
| 7-41S64 | 3/8" x 1/4" |
| 7-41S7 | 7/16" |
| 7-41S8 | 1/2" |

**FLARE - 45 SERIES
x MIP TEES**

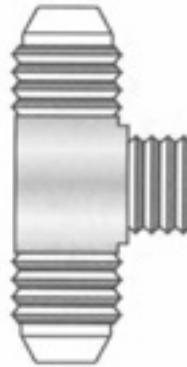

| PART# | SIZE |
|--------|-------------|
| 7-4564 | 3/8" x 1/4" |
| 7-4566 | 3/8" x 3/8" |
| 7-4568 | 3/8" x 1/2" |

**FLARE - 55 SERIES
90° ELBOW**



| PART# | SIZE |
|--------|-------|
| 7-554 | 1/4" |
| 7-555 | 5/16" |
| 7-558 | 1/2" |
| 7-5510 | 5/8" |

**FLARE - 52 SERIES
CROSS**

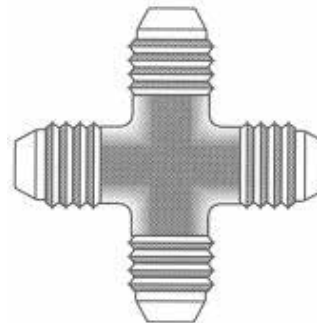

| PART# | SIZE |
|-------|------|
| 7-526 | 3/8" |
| 7-528 | 1/2" |

**FLARE - 50 SERIES X FIP
90° ELBOW**

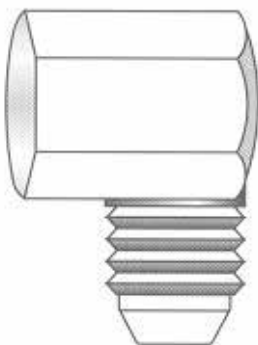

| PART# | SIZE |
|---------|-------------|
| 7-5066 | 3/8" |
| 7-5068 | 3/8" x 1/2" |
| 7-50612 | 3/8" x 3/4" |
| 7-5084 | 1/2" x 1/4" |
| 7-5086 | 1/2" x 3/8" |
| 7-5088 | 1/2" |
| 7-50812 | 1/2" x 3/4" |

**FLARE - 49 SERIES x MIP
90° ELBOW**



| PART# | SIZE |
|---------|--------------|
| 7-4942 | 1/4" x 1/8" |
| 7-4944 | 1/4" |
| 7-4954 | 5/16" x 1/4" |
| 7-4964 | 3/8" x 1/4" |
| 7-4966 | 3/8" |
| 7-4968 | 3/8" x 1/2" |
| 7-4984 | 1/2" x 1/4" |
| 7-4986 | 1/2" x 3/8" |
| 7-4988 | 1/2" |
| 7-49108 | 5/8" x 1/2" |

Two piece: body and nut. Straights and shapes are manufactured from CA360, CA345 or CA377 brass. 45° Flare. Heavy duty flare fittings are manufactured to SAE specifications. Compatible with copper, brass, aluminum and steel hydraulic tubing that can be flared. Used on low, medium and high pressure lines under the most adverse conditions. Fair vibration resistance. The long nut offers greater support. Temperature range from -65° to +250° F.

BRASS FLARE & COMPRESSION FITTINGS

**FLARE - 46
SERIES
x FIP
COUPLING**



| PART# | SIZE |
|----------|--------------|
| 7-4642 | 1/4" x 1/8" |
| 7-4644 | 1/4" |
| 7-4654 | 5/16" x 1/4" |
| 7-4662 | 3/8" x 1/8" |
| 7-4666 | 3/8" |
| 7-4668 | 3/8" x 1/2" |
| 7-4684 | 1/2" x 1/4" |
| 7-4686 | 1/2" x 3/8" |
| 7-4688 | 1/2" |
| 7-46812 | 1/2" x 3/4" |
| 7-46108 | 5/8" x 1/2" |
| 7-461012 | 5/8" x 3/4" |
| 7-461212 | 3/4" x 3/4" |

**COMPRESSION
- 62 SERIES
UNION**



| PART# | SIZE |
|---------|--------------|
| 7-622 | 1/8" |
| 7-623 | 3/16" |
| 7-624 | 1/4" |
| 7-6242 | 1/4" x 1/8" |
| 7-625 | 5/16" |
| 7-6254 | 5/16" x 1/4" |
| 7-626 | 3/8" |
| 7-6264 | 3/8" x 1/4" |
| 7-628 | 1/2" |
| 7-6286 | 1/2" x 3/8" |
| 7-6210 | 5/8" |
| 7-62106 | 5/8" x 3/8" |
| 7-62108 | 5/8" x 1/2" |
| 7-6214 | 7/8" |

**FLARE - 48
SERIES
x MIP
COUPLING**



| PART# | SIZE |
|----------|--------------|
| 7-4842 | 1/4" x 1/8" |
| 7-4844 | 1/4" |
| 7-4846 | 1/4" x 3/8" |
| 7-4848 | 1/4" x 1/2" |
| 7-4854 | 5/16" x 1/4" |
| 7-4856 | 5/16" x 3/8" |
| 7-4864 | 3/8" x 1/4" |
| 7-4866 | 3/8" |
| 7-4868 | 3/8" x 1/2" |
| 7-48612 | 3/8" x 3/4" |
| 7-4884 | 1/2" x 1/4" |
| 7-4886 | 1/2" x 3/8" |
| 7-4888 | 1/2" x 1/2" |
| 7-48108 | 5/8" x 1/2" |
| 7-481012 | 5/8" x 3/4" |
| 7-48812 | 1/2" x 3/4" |

**COMPRESSION
- 66 SERIES x
FIP COUPLING**



| PART# | SIZE |
|---------|--------------|
| 7-6642 | 1/4" x 1/8" |
| 7-6644 | 1/4" |
| 7-6648 | 1/4" x 1/2" |
| 7-6654 | 5/16" x 1/4" |
| 7-6662 | 3/8" x 1/8" |
| 7-6664 | 3/8" x 1/4" |
| 7-6666 | 3/8" |
| 7-6668 | 3/8" x 1/2" |
| 7-6684 | 1/2" x 1/4" |
| 7-6686 | 1/2" x 3/8" |
| 7-6688 | 1/2" |
| 7-66108 | 5/8" x 1/2" |

**COMPRESSION
60 SERIES
SLEEVE**



| PART# | SIZE |
|-------|-------|
| 7-602 | 1/8" |
| 7-603 | 3/16" |
| 7-604 | 1/4" |
| 7-605 | 5/16" |
| 7-606 | 3/8" |
| 7-607 | 7/16" |
| 7-608 | 1/2" |

**COMPRESSION
- 61 SERIES
SHORT NUT**



| PART# | SIZE |
|--------|-------|
| 7-613 | 3/16" |
| 7-614 | 1/4" |
| 7-615 | 5/16" |
| 7-616 | 3/8" |
| 7-618 | 1/2" |
| 7-6110 | 5/8" |

**COMPRESSION
64 SERIES TEE**



| PART# | SIZE |
|--------|-------|
| 7-643 | 3/16" |
| 7-644 | 1/4" |
| 7-645 | 5/16" |
| 7-646 | 3/8" |
| 7-648 | 1/2" |
| 7-6410 | 5/8" |

- Three piece unit: body, nut and sleeve.
- Straights and shapes are manufactured from CA360, CA345, CA377.
- Compatible with copper, brass, aluminum and thermoplastic tubing. (Thermoplastic tubing requires the use of a brass insert for support.)
- Low pressure air, oil, water and gas up to a maximum pressure of 400 psi.
- Fair vibration resistance
- The long nut can be used for greater vibration application.

BRASS FLARE & COMPRESSION FITTINGS

COMPRESSION - 65 SERIES 90° ELBOW



| PART# | SIZE |
|---------|-------------|
| 7-653 | 3/16" |
| 7-654 | 1/4" |
| 7-656 | 3/8" |
| 7-6564 | 3/8" x 1/4" |
| 7-658 | 1/2" |
| 7-6510 | 5/8" |
| 7-65106 | 5/8" x 3/8" |

COMPRESSION - 61C SERIES CAP



| PART# | SIZE |
|--------|------|
| 7-61C4 | 1/4" |
| 7-61C6 | 3/8" |

COMPRESSION - 68 SERIES x MIP COUPLING



| PART# | SIZE | PART# | SIZE |
|--------|--------------|----------|-------------|
| 7-6822 | 1/8" | 7-6866 | 3/8" |
| 7-6842 | 1/4" x 1/8" | 7-6868 | 3/8" x 1/2" |
| 7-6844 | 1/4" | 7-6884 | 1/2" x 1/4" |
| 7-6846 | 1/4" x 3/8" | 7-6886 | 1/2" x 3/8" |
| 7-6848 | 1/4" x 1/2" | 7-6888 | 1/2" |
| 7-6852 | 5/16" x 1/8" | 7-68106 | 5/8" x 3/8" |
| 7-6854 | 5/16" x 1/4" | 7-68108 | 5/8" x 1/2" |
| 7-6862 | 3/8" x 1/8" | 7-681012 | 5/8" x 3/4" |
| 7-6864 | 3/8" x 1/4" | 7-681412 | 7/8" x 3/4" |

COMPRESSION - 69 SERIES x MIP 90° ELBOW



| PART# | SIZE | PART# | SIZE |
|--------|--------------|---------|-------------|
| 7-6944 | 1/4" | 7-6968 | 3/8" x 1/2" |
| 7-6946 | 1/4" x 3/8" | 7-6984 | 1/2" x 1/4" |
| 7-6948 | 1/4" x 1/2" | 7-6986 | 1/2" x 3/8" |
| 7-6952 | 5/16" x 1/8" | 7-6988 | 1/2" |
| 7-6954 | 5/16" x 1/4" | 7-69812 | 1/2" x 3/4" |
| 7-6962 | 3/8" x 1/8" | 7-69106 | 5/8" x 3/8" |
| 7-6964 | 3/8" x 1/4" | 7-69108 | 5/8" x 1/2" |
| 7-6966 | 3/8" | | |

COMPRESSION - 70 SERIES x FIP 90° ELBOW



| PART# | SIZE | PART# | SIZE |
|--------|-------------|--------|-------------|
| 7-7042 | 1/4" x 1/8" | 7-7066 | 3/8" |
| 7-7044 | 1/4" | 7-7068 | 3/8" x 1/2" |
| 7-7062 | 3/8" x 1/8" | 7-7086 | 1/2" x 3/8" |
| 7-7064 | 3/8" x 1/4" | 7-7088 | 1/2" |

SECTION "L" PLUMBERS TOOLS INDEX

| | | | |
|---------------------------------|------|---------------------------------|------|
| ABS Pipe Cutter | L-6 | Key - Sillcock | L-11 |
| Aerator Gauge | L-15 | Key- Water Meter | L-16 |
| Air Test Gauge | L-18 | Knockout Test Caps | L-23 |
| All American Test Plugs | L-25 | Lead Joint Runners | L-17 |
| Antifreeze Tester | L-29 | Lead Ladles | L-17 |
| Auger - CanisterType | L-27 | Lead Pots | L-17 |
| Auger - Closet | L-27 | Mesh - Plumbers | L-8 |
| Auger - Toilet & Urinal | L-26 | MIL 3 PEX Tools | L-3 |
| Auger - Zip Plastic Snake | L-27 | O - Ring Pick | L-9 |
| Basin Wrenches | L-9 | Partition Stop Key - Brass | L-11 |
| Basket Strainer Wrench | L-16 | PEX Tools- Angled Head | L-3 |
| Bibb Seat Tools | L-10 | PEX Clamp Buster | L-5 |
| Big Yank Handle Puller | L-14 | PEX Ring Cutter | L-5 |
| Big Yank Sr.™ Handle Puller | L-14 | PEX Tools | L-1 |
| Bladder - Drain Cleaning | L-22 | PEX Tools - Clamp Removal Tool | L-5 |
| Blow up Test Plugs | L-21 | PEX Tools - Clinch Clamp | L-4 |
| Brush - 4 in 1 | L-9 | PEX Tools - Easy Shear | L-5 |
| Brush - Fitting | L-8 | PEX Tools - MIL 3 | L-3 |
| Cane Rod Plunger | L-29 | PEX Tools - Tubing Cutter | L-6 |
| Cast Iron Test Plugs | L-23 | Pick Up Tool - Magnet | L-7 |
| Caulking Tools | L-17 | Pipe Cutters ABS / PVC | L-6 |
| Cleanout Plug Wrench | L-10 | Pipe Plug | L-13 |
| Clinch Clamp PEX Tool | L-4 | Plumbers Mesh | L-8 |
| Crimp Tools - PEX | L-1 | Plunger - Funneled Nose Plastic | L-28 |
| Cutter - for PEX Rings | L-5 | Plunger - Wood Handle | L-28 |
| Drain Cleaning Bladders | L-22 | PO Plug Wrench | L-15 |
| Easy Cut Jaws | L-13 | Pocket Crimper | L-2 |
| Easy Shear Ring Cutter Tool | L-5 | Quick Nutcracker Tool | L-13 |
| Extension Hoses for Test Plugs | L-21 | Quick Sweat Kit | L-14 |
| Faucet Reseating Tool | L-9 | Radiator Spud Wrench | L-11 |
| Fitting Brushes | L-8 | Rabbits | L-16 |
| Fitting Saver Tool | L-16 | Rod Plumbers | L-29 |
| Flush Valve Wrench | L-20 | Safe-T - Seal Test Plugs | L-24 |
| Four Way Key | L-11 | Sand Cloth - Plumbers | L-8 |
| Gauge - Aerator | L-15 | Sargent PEX Tools | L-1 |
| Gauge - AirTest | L-18 | Seat Gauge | L-15 |
| Gauge - Handle | L-15 | Shower Drain Wrench | L-15 |
| Gauge - Seat & Stem | L-15 | Sink Plunger, Kitchen | L-28 |
| Gauge - Water Test | L-18 | SLOAN - Easy Out Tool | L-10 |
| Grab All Pick up Tool | L-20 | SLOAN Tailpiece Tool | L-19 |
| Hand Spinner - DAHLE | L-25 | Smart Dumbbell | L-12 |
| Hand Spinners | L-26 | Snake Auger - Plastic Zip | L-27 |
| Handle Gauge | L-15 | Spud Wrenches | L-12 |
| Handle Pullers | L-14 | Stem & Cartridge Puller Tool | L-13 |
| Impact Handle Puller | L-14 | Stem Gauge | L-15 |
| Inspection Mirror | L-7 | Strainer Wrench 4 in 1 | L-19 |
| Key - 4 Way | L-11 | Strap Wrench - Rubber Test Caps | L-20 |
| Key - Heater Furnace Loglighter | L-11 | Test Caps | L-23 |
| Key - Partition Stop | L-11 | Test Caps - Knockout | L-23 |

SECTION "L" PLUMBERS TOOLS INDEX

| | | | |
|-----------------------------|------|-------------------------------|------|
| Test Plug - ALL AMERICAN | L-25 | Wrench - Strainer Nut | L-16 |
| Test Plug - Blow Up | L-21 | Wrench - Strap | L-29 |
| Test Plug- Cast Iron | L-23 | Wrench - Torque | L-29 |
| Test Plug - Expandable | L-25 | Wrench - Tub & Shower Valve | L-10 |
| Test Plug - Hoses | L-21 | Wrench - Water Heater Element | L-12 |
| Test Plug - Nylon | L-22 | | |
| Test Plug - Safe-T-Seal | L-24 | | |
| Test Plug - Wing Nut | L-23 | | |
| Tire Pumps | L-18 | | |
| Toilet Auger | L-26 | | |
| Toilet Auger Hand Spinner | L-26 | | |
| Toilet Plungers | L-28 | | |
| Tools - Bibb Seat | L-10 | | |
| Tools - Grab All Pick Up | L-20 | | |
| Tools - Lead | L-17 | | |
| Tools - LED Lighted | L-7 | | |
| Tools - Magnet | L-7 | | |
| Tools - Pex | L-1 | | |
| Tools - Pex Angled Head | L-3 | | |
| Tools - Pex for SS Rings | L-4 | | |
| Tools - SLOAN | L-19 | | |
| Tools - Water Suction | L-19 | | |
| Torque Wrench - No Hub | L-29 | | |
| Tubing Cutters | L-6 | | |
| Urinal Auger | L-26 | | |
| Water Heater Element Wrench | L-12 | | |
| Water Meter Key | L-16 | | |
| Water Suction Tool | L-19 | | |
| Water Test Gauge | L-18 | | |
| Wing Nut Test Plug | L-23 | | |
| Wrench - 3 in 1 Radiator | L-11 | | |
| Wrench - Basin | L-9 | | |
| Wrench - Basin Telescoping | L-9 | | |
| Wrench - Basket Strainer | L-16 | | |
| Wrench - Bubbler | L-9 | | |
| Wrench - Classic Drain | L-15 | | |
| Wrench - Cleanout | L-10 | | |
| Wrench - Closet Seat Nut | L-16 | | |
| Wrench - Dumbell | L-12 | | |
| Wrench - Flush Valve | L-20 | | |
| Wrench - PO Plug | L-15 | | |
| Wrench - Radiator Spud | L-11 | | |
| Wrench - Rubber Strap | L-20 | | |
| Wrench - Socket Nut | L-20 | | |
| Wrench - Spud | L-12 | | |
| Wrench - Spud | L-19 | | |
| Wrench - Strainer 4 in 1 | L-19 | | |
| | | | |

SOFT TOUCH PEX TOOLS



PEX CRIMP TOOL - 12" HANDLE



- For 1/2" or 3/4" PEX pipe sizes
- Crimps conform to A.S.T.M. specifications
- Tools are supplied with a go/no-go gauge
- Tool length is 12" ("S" Length) and weighs 3 lbs.
- The Soft-Touch short handle tools are well suited for manifold and difficult access areas
- High mechanical advantage in a compact design make this product the plumbing contractor's first choice
- Made in USA

PEX CRIMP TOOL - 16" HANDLE



- For 1/2" or 3/4" PEX pipe sizes
- Crimps conform to A.S.T.M. specifications
- Tools are supplied with a go/no-go gauge
- Tool length is 16" ("M" Length) and weighs 4 lbs.
- The Soft-Touch medium handle tools are considered the standard of the industry
- The longer length on this tool promotes productivity and minimizes user fatigue
- Made in USA

| PART# | DESCRIPTION |
|----------------|--------------|
| 9202STS | For 1/2" PEX |
| 9203STS | For 3/4" PEX |

| PART# | DESCRIPTION |
|----------------|--------------|
| 9202STM | For 1/2" PEX |
| 9203STM | For 3/4" PEX |
| 9204STM | For 1" PEX |

PEX CRIMP TOOL - 19" HANDLE



- For 1/2" or 3/4" PEX pipe sizes
- Crimps conform to A.S.T.M. specifications
- Tools are supplied with a go/no-go gauge
- Tool length is 19" ("L" Length) and weighs 4 lbs.
- The Soft-Touch long handle tools provide maximum reach with the lowest crimp loads
- Made in USA

PEX CRIMP TOOL - DUAL 1/2" & 3/4" RINGS



- Dual Tool for 1/2" & 3/4" PEX pipe sizes
- Crimps conform to A.S.T.M. specifications
- Tools are supplied with a go/no-go gauge
- The Soft-Touch medium handle tools are considered the standard of the industry
- The longer length on this tool promotes productivity and minimizes user fatigue
- Made in USA

| PART# | DESCRIPTION |
|----------------|--------------|
| 9202STL | For 1/2" PEX |
| 9203STL | For 3/4" PEX |

| PART# | DESCRIPTION |
|----------------|-----------------------------|
| 9206STS | 12" handle 1/2" & 3/4" tool |
| 9205STM | 16" handle 1/2" & 3/4" tool |
| 9205STL | 19" handle 1/2" & 3/4" tool |

LYNCARS PEX TOOLS

LYNCAR PEX CRIMP TOOL



- LYNCAR'S soft-grip mid-short handle tools are the best value tool for PEX manifold work, also ideal for difficult access areas
- Compact design and high mechanical leverage make this tool the service plumber's first choice
- For 1/2" or 3/4" PEX pipe sizes
- Crimps conform to A.S.T.M. specifications
- Supplied with a go/no-go gauge

| PART# | HANDLE SIZE | DESCRIPTION |
|-------|-------------|--------------------|
| 9301 | 14" | For 1/2" PEX rings |
| 9302 | 14" | For 3/4" PEX rings |
| 9303 | 18" | For 1/2" PEX rings |
| 9304 | 18" | For 3/4" PEX rings |

LYNCAR COMBO PEX CRIMP TOOL
- 1/2" & 3/4"

- LYNCAR'S soft-grip long handle tools are considered the best value in PEX crimp tools
- The longer handle length is better suited for productivity and minimizes user fatigue
- Combo crimp head for 1/2" & 3/4" PEX pipe sizes
- Supplied with a go/no-go gauge
- 14" handle
- Crimps conform to A.S.T.M. specifications

| PART# | DESCRIPTION |
|-------|-------------------|
| 9309 | 1/2" & 3/4" combo |

RIGHT ANGLE SOFT TOUCH CRIMP TOOL



- 12" long
- 1/2" or 3/4" head
- Provides a new level of access in confined crimp locations
- Handles can be opened unobstructed for overhead in between joist crimping, in a cabinet or standing over a pipe which require a flush crimp to any surface
- Crimps to ASTM F1807 specifications
- Crimp head is tilted to 90 degrees
- Toggle action assures all rings are crimped to spec
- Supplied with a go/no go size gauge

| PART# | DESCRIPTION |
|------------|-------------|
| 9202STS90A | 1/2" head |
| 9203STS90A | 3/4" head |

POCKET CRIMPER



- Crimps standard black copper PEX rings
- Preferred by professionals
- Use for 3/8", 1/2" and 3/4"
- Includes tool, pouch and a go/no go size gauge
- 6 pack is a counter display for quick impulse sales

| PART# | DESCRIPTION |
|-------|----------------|
| 9312 | Pocket crimper |

PEX TOOLS

L

MIL 3 ANGLE CRIMPMAKER TOOL



- Easy-to-use PEX MIL 3 tools
- Recognized by plumbers as the premium PEX crimping angle tool
- Compact, can reach into tight spaces
- MIL 3 PEX tools ensure a tight PEX crimp every time
- Made in the U.S.A
- Supplied with a go/no-go gauge

| PART# | DESCRIPTION |
|-------|----------------|
| 9321 | 1/2" PEX rings |
| 9322 | 3/4" PEX rings |

MIL 3 ANGLE CRIMPMAKER 1"



- Easy-to-use PEX MIL 3 tools
- The only 1" Angle Pex Tool available
- Compact, can reach into tight spaces
- MIL 3 PEX tools ensure a tight PEX crimp every time
- Made in the U.S.A
- Supplied with a go/no-go gauge

| PART# | DESCRIPTION |
|-------|--------------|
| 9323 | 1" PEX rings |

ANGLED HEAD COMPACT CRIMP TOOL



- The LYNCAR SoftCrimp **part#9310** & **part#9311** are professional quality heavy-duty crimpers that have an "open-stop" for one handed crimping
- The angled head design make it easily used in all tight spots
- Available for crimp ring size 1/2" and 3/4"
- Made in the U.S.A
- Supplied with a go/no-go gauge

| PART# | DESCRIPTION |
|-------|--------------------|
| 9310 | For 1/2" PEX rings |
| 9311 | For 3/4" PEX rings |

LYNCAR PEX CRIMP TOOL 1"



- LYNCAR'S Soft-Grip mid-short handle tools are the best value tool for PEX manifold work, also ideal for difficult access areas
- Compact design and high mechanical leverage make this tool the service plumber's first choice
- Crimps conform to A.S.T.M. specifications
- Made in the U.S.A
- Supplied with a go/no-go gauge

| PART# | HANDLE SIZE | DESCRIPTION |
|-------|-------------|------------------|
| 93071 | 15" | For 1" PEX Rings |

PLUMBER'S TOOLS

PEX TOOLS

**LYNCAR SSC PEX "CLINCH CLAMP"
RATCHET TOOL**

- Lyncar's SSC style clamp tool makes connections for PEX Tubing with the SSC style clamps of different sizes
- This SSC style PEX Tool is gaining in popularity due to its ease of use
- Covers 5 sizes from 3/8" to 1" SSC PEX Clamp Ring sizes
- Crimps conform to A.S.T.M. specifications
- Tool length is 19" ("L" Length) and weighs 4 lbs.
- Professional Model
- Built for every day use by the construction Plumber
- More comfortable hand grip and a robust crimping mechanism for long tool life.

| PART# | DESCRIPTION |
|--------------|-----------------------------------|
| 9308 | Contractor grade blister packaged |
| 9308P | Professional model heavy duty |

PEX TOOL CLINCH CLAMP TOOL

- Lyncar's unique 3 handle design
- Effective for all size stainless steel clamps (3/8", 1/2", 3/4" and 1")
- Tool calibration gauge included
- Meets ASTM F-2098 standards
- Ratchet mechanism, compact design

| PART# | DESCRIPTION |
|--------------|--|
| 93083 | Clinch clamp tool with third handle design |

PEX TOOL HD FOR SS RING, ONE HAND LED LIGHT

- PEX tool for SSC type clamps
- One hand operation
- LED light confirms a good clamp
- Spring loaded handle for easy operation

| PART# | DESCRIPTION |
|-------------|-------------------------------|
| 9313 | PEX tool H.D., with LED light |

PEX TOOLS

EASY SHEAR BY LYNCAR



- Available exclusively from LYNCAR
- PEX rings are great - but when they have to be removed they become one of the biggest challenges a plumber faces
- Saves all 1/2" and 3/4" PEX fittings
- Saves you TIME and MONEY
- Easy to use even in difficult places
- Needs no adjustments
- High quality replaceable blades
- Will not damage your pipe or fittings
- Tool to be used on copper rings only
- Canadian patent#CA 2274034
- US patent#6,769,181

| PART# | DESCRIPTION |
|---------------|--------------------|
| 7402ES | For 1/2" PEX rings |
| 7403ES | For 3/4" PEX rings |
| 7402B | Replacement blade |

PEX CLAMP BUSTER



- Removes the SSC style fitting clamps in order to remove the PEX tubing
- Includes the socket wrench
- Works on all sizes of SSC style clamps

| PART# | DESCRIPTION |
|---------------|--------------------|
| 9308RT | Clamp removal tool |

PEX RING CUTTER

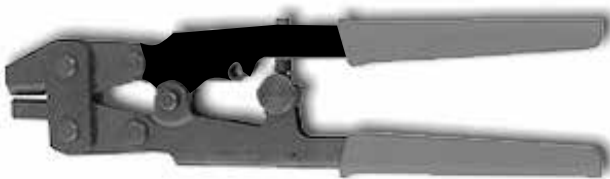

- A fitting recovery tool that does not change sealing surfaces
- Fits all PEX pipe sizes
- Cutting blade will only penetrate the PEX pipe
- No fitting damage with this tool
- Two cuts on the ring will allow the user to reclaim the fitting
- Approx 8" long

| PART# | DESCRIPTION |
|---------------|--------------------------------|
| 7407ES | PEX ring remover, USA made |
| 9315 | PEX ring remover, LYNCAR model |

PEX TOOL COMPOSITE HANDLE KIT



- LYNCAR'S composite handle crimp tool for 3/8", 1/2", 3/4" and 1" PEX copper rings
- This unique tool has built-in jaws for 1/2" and 1" PEX copper rings
- The 1" cavity is designed to accept quick release interchangeable dies for 3/4" PEX copper rings

| PART# | DESCRIPTION |
|-------------|---------------------------|
| 9314 | Composite handle PEX tool |

PEX TOOLS

ABS SUPERPRO PREMIUM CUTTER



- Premium blade cuts ABS & PVC
- Easy one hand operation
- Cuts all types of plastic pipe including ABS
- Blister packaged
- Replaceable stainless steel blade

| PART# | DESCRIPTION |
|-------|------------------------------|
| 4683 | Cutter heavy duty to 2" pipe |
| 4683B | Blade |

ABS HEAVY DUTY CUTTER

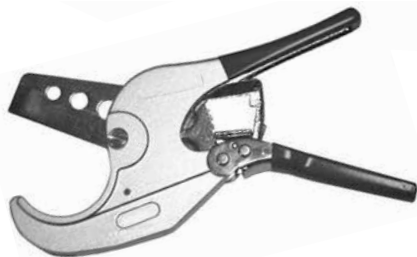

- Heavy duty cutting blade
- Cuts all types of plastic pipe
- Heavy duty steel construction
- Replaceable stainless steel blade

| PART# | DESCRIPTION |
|-------|------------------------------|
| 4682 | Cutter heavy duty to 2" pipe |
| 4682B | Blade |

PVC PIPE CUTTER



- | | |
|----------------------|-------------------------|
| part# 4657 | part# 4658 |
| - 5 Step Action | - 3 Step Action |
| - Carbon steel blade | - Stainless Steel Blade |

- part#4676**
- PVC & ABS Pipe
 - Stainless Steel blade and ratchet

| PART# | DESCRIPTION |
|-------|---|
| 4657 | Complete, cuts up to 1-1/4" plastic |
| 4657B | Blade for part#4657 |
| 4658 | Complete, cuts up to 1" Plastic |
| 4658B | Blade for part#4658 |
| 4676 | Complete, premium, cuts up to 1-1/4" CPVC |
| 4676B | Blade for part#4676 |

PROFESSIONAL PEX CUTTER 1-1/4"



- For cutting up to 1-1/4" soft pipe & hose
- Large blade & mouth
- Spring open & close for easy use

| PART# | DESCRIPTION |
|--------|-------------------|
| 4668P | PEX cutter |
| 4668PB | Replacement blade |

PEX CUTTER



- For cutting up to 1-1/4" soft pipe and hose
- ABS Body

| PART# | DESCRIPTION |
|-------|-------------------|
| 4668 | PEX cutter |
| 4668B | Replacement blade |

PLUMBERS TOOLS

L

MAGNETIC TELESCOPING INSPECTION MIRROR



- Blister packed
- Mirror is 4 cm
- Magnet can hold up to 1 lb
- Telescope extends to 24"

LED TELESCOPIC LIGHT INSPECTION MIRROR



- Blister packed
- Turns on when extended and off when returned to the closed position
- Telescope extends up to 7"

| PART# | DESCRIPTION |
|-------|-------------------|
| 4914 | Inspection mirror |

| PART# | DESCRIPTION |
|-------|---|
| 4915 | Professional inspection mirror with LED light |

FLEXIBLE MAGNET PICK UP TOOL



- Poly bag display
- Magnet & flexible
- Comfort grip handle
- 24" long cable
- 2 kg magnet

| PART# | DESCRIPTION |
|-------|--------------------------|
| 4916 | 2 kg magnet pick up tool |

TELESCOPING WHITE LIGHT LED & MAGNET TOOL



- Blister packed
- Illuminates from the front and from the side
- Turns on when extended and off when returned to the closed position
- Magnet will hold up to 1 lb
- Telescope extends up to 24"

| PART# | DESCRIPTION |
|-------|-----------------------------|
| 4920 | Telescoping white light LED |

PLUMBER'S TOOLS

FITTING BRUSHES

PREMIUM QUALITY FITTING BRUSH



- Consider our premium fitting brush when making your selection
- The highest quality, finest fitting brush available! spring tempered stainless steel wire bristles
- Precision trimmed to ensure maximum contact of the bristle ends and cutting edges
- Interlaced double spiral construction
- Quadruple galvanized steel stems
- Double spiral / double stem stainless steel wire (4 wires)
- Brush bristles are twisted between four stem wires with two layers of bristles
- Each layer is perpendicular to the other

| PART# | DESCRIPTION |
|-------|-------------|
| 5126 | 1/2" |
| 5128 | 3/4" |
| 5130 | 1" |
| 5131 | 1-1/4" |
| 5132 | 1-1/2" |
| 5133 | 2" |

STANDARD QUALITY FITTING BRUSH



- High carbon crimp steel bristles
- Single spiral / single stem (2 wires)
- Brush bristles are twisted between two stem wires with a single wire on each side

| PART# | DESCRIPTION |
|-------|-------------|
| 5114 | 1/2" |
| 5116 | 3/4" |
| 5118 | 1" |
| 5119 | 1-1/4" |
| 5120 | 1-1/2" |
| 5121 | 2" |

OPEN MESH CLOTH - PLUMBERS



- 180 grit
- Aluminum oxide
- Resin bond
- Boxed

| PART# | DESCRIPTION |
|-------|-------------|
| 3108 | 5 yd box |
| 3109 | 10 yd box |

SAND CLOTH - PLUMBERS



- Specially formulated for use in preparing copper fittings and tubing for soldering
- Box packaged

| PART# | DESCRIPTION |
|-------|-------------|
| 3103 | 5 yd box |
| 3102 | 10 yd box |
| 3105 | 25 yd box |

PLUMBERS TOOLS

4 IN 1 BRUSH



- High carbon crimp steel bristles

| PART# | DESCRIPTION |
|-------|----------------------------------|
| 5150 | 1/2" & 3/4" fitting & tube brush |

PROFESSIONAL FAUCET RESEATER KIT



- KIT INCLUDES:
- 4- Hardened steel cutters for various size faucets
 - 1- Guide cone
 - 4- Faucet washer
 - 1- Solid brass screw
 - 1- Long shaft for tub & showers

| PART# | DESCRIPTION |
|--------|---------------|
| 12844P | Reseater tool |

FOUNTAIN 2-IN-1 WRENCH



- Tightens or loosens cartridge retaining bushing
- Prevents bushing thread damage which causes leaks

| PART# | DESCRIPTION |
|-------|------------------|
| 7047 | Key for bubblers |

WRENCH - TELESCOPING BASIN



- Extends from 9" to 16"
- Swivel jaw with spring

| PART# | DESCRIPTION |
|-------|-------------------|
| 4573 | Extends 9" to 16" |

O-RING PICK



- O-ring pick for removal of washers & o-rings
- 18ga wire

| PART# | DESCRIPTION |
|-------|-------------|
| 5200 | O-ring pick |

WRENCH - REGULAR BASIN



- For use on basin nuts, ballcocks & flush valves
- Cadmium plated
- Jaw has springs
- Swivel head operates right or left

| PART# | DESCRIPTION |
|-------|-------------|
| 4574 | 11" wrench |
| 4590 | 15" wrench |

PLUMBERS TOOLS

WRENCH - TUB & SHOWER VALVE



- 5 piece set of wrenches with wire bar
- Total 10 sizes: 21/31", 27/32", 29/32", 31/32", 1-1/32", 1-3/32", 1-5/32", 1-9/32", 1-11/32", 1-7/16"
- For installing or removing recessed valve stems

| PART# | DESCRIPTION |
|-------|-----------------------------|
| 5300 | Wrench - tub & shower valve |

CLEANOUT PLUG WRENCH



- This unique tool fits either slotted or square countersunk cleanout plugs
- Strong, malleable iron

| PART# | DESCRIPTION |
|-------|----------------------|
| 4567 | Cleanout plug wrench |

BIBB SEAT TOOLS

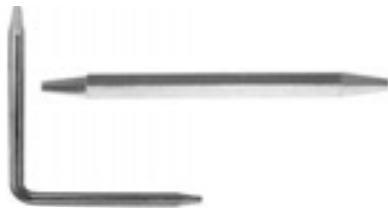

- Straight and angled models
- For all faucet seats
- Cadmium plated
- Heat treated

| PART# | DESCRIPTION |
|-------|-------------------------|
| 4563 | Square x Hex x Straight |
| 4564 | Tapered - Angled |

BIBB SEAT TOOL SET



SET INCLUDES:

- 1- 3/8" x 7/16" ratcheting box wrench
- 1- Small hex/large hex tapered bibb seat tool
- 1- Small square/large square no taper bibb seat tool

| PART# | DESCRIPTION |
|-------|--------------------|
| 4568 | Bibb seat tool set |

CANADIAN STYLE BIBB SEAT TOOL



- For all faucet seats
- Cadmium plated
- Heat treated
- 6 Step - Angled

| PART# | DESCRIPTION |
|-------|-------------------------------|
| 4561 | Canadian style bibb seat tool |

BIBB SEAT TOOL, THREADED ENDS, PROFESSIONAL



- Left hand threads
- Install and remove faucet seats
- Grabs seat when inside surface is corroded
- 6-1/2" long
- Black finished
- Carded

| PART# | DESCRIPTION |
|-------|----------------|
| 4566 | Bibb seat tool |

PLUMBERS TOOLS

EASY OUT TOOL FOR SLOAN FLUSHMATE CARTRIDGE

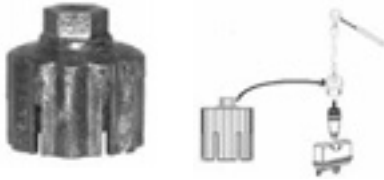

- Fast, heavy duty
- Easy in- easy out
- Eliminate broken cartridges and skinned knuckles
- The original easy-out SLOAN flushmate cartridge extractor tool

| PART# | DESCRIPTION |
|--------------|--|
| 10138 | Easy out tool for cartridge OEM ref#ST100500 |

KEY - SILLCOCK



- Die Cast

| PART# | DESCRIPTION |
|-------------|-------------|
| 1699 | 1/4" key |
| 1700 | 5/16" key |

KEY - HEATER FURNACE LOGLIGHTER



- Die Cast
- Stem length: 10"

| PART# | DESCRIPTION |
|-------------|-------------|
| 1706 | 1/4" |
| 1707 | 5/16" |

KEY - FOUR WAY



- Fits stopcocks, sillcocks and valves
- Sizes are 1/4" to 9/32" and 5/16" to 11/32"
- Precision machined plated steel

| PART# | DESCRIPTION |
|-------------|----------------|
| 1701 | Key - four way |

WRENCH - 3 IN 1 RADIATOR VALVE



- Inserts
- Rethreads
- Extracts

| PART# | DESCRIPTION |
|-------------|---------------------|
| 4947 | Chrome plated brass |

PARTITION STOP KEY - BRASS



- Partition or access keys
- 4 lengths available
- Machined brass

| PART# | DESCRIPTION |
|-------------|-------------|
| 1486 | 3" long |
| 1487 | 6" long |
| 1488 | 9" long |
| 1489 | 12" long |

WRENCH - RADIATOR SPUD



- 6 tiered wrench 1/2" - 2"
- Cast aluminum

| PART# | DESCRIPTION |
|-------------|-------------|
| 4558 | Spud wrench |

PLUMBERS TOOLS

WRENCH WATER HEATER ELEMENT



- Removes water heater elements
- Heavy duty construction for 1-1/2" elements

| PART# | DESCRIPTION |
|-------|-----------------------------|
| 4946 | Wrench water heater element |

DUMBELL WRENCH - DIY



- Import, D.I.Y. grade
- Sorry no guarantee

| PART# | DESCRIPTION |
|-------|----------------|
| 4556 | Dumbell wrench |

SMART DUMBELL



- Installs or removes drains without crossbars (KOHLER, AMERICAN STANDARD)
- Heavy duty die-cast aluminum finishes
- Either a crescent wrench or large phillips screwdriver can be used to turn the tool
- Saves time, money and aggravation

US made, Contractor Grade, Life Time Guarantee

| PART# | DESCRIPTION |
|-------|---------------|
| 4554 | Smart dumbell |

WRENCH - SPUD



- For slip nuts, lock nuts and strainer nuts
- 10" non adjusting, 1" to 3" capacity
- One piece head treated forging

| PART# | DESCRIPTION |
|-------|---------------|
| 4570 | Wrench - spud |

WRENCH - ADJUSTABLE SPUD



- 10" length
- 1" to 3" capacity
- For slip nuts, locknuts and strainer nuts

| PART# | DESCRIPTION |
|-------|--------------------------|
| 4571 | Wrench - adjustable spud |

WRENCH - INTERNAL SPUD



- A must to install or remove urinal and closet spud, waste and overflows, 4" capacity
- Cushioned grip

| PART# | DESCRIPTION |
|-------|------------------------|
| 4562 | Wrench - internal spud |

PLUMBERS TOOLS

QUICK NUTCRACKER™



- Patent Number 4,365,413
- Quickly removes corroded 1/2" zinc locknuts from faucet shanks. Heat treated cutter blades
- Ball thrust bearings
- Durable black oxide finish
- Will work on faucet shanks with only three threads showing
- For use on:
 - 1/2" shank single basin faucet
 - 1/2" shank centres
 - 1/2" shank kitchen faucets

| PART# | DESCRIPTION |
|-------|-------------------|
| 7000 | QUICK NUTCRACKER™ |

MOEN® STEM AND CARTRIDGE PULLER



- Removes MOEN® stems and MOEN® cartridges from faucets and shower valves
- Removes brass cartridges
- Removes brass stems
- Removes plastic stems & cartridges
- Precision made
- High quality steel components
- One piece construction
- Easy to use

| PART# | DESCRIPTION |
|-------|------------------------------|
| 7040 | MOEN stem & cartridge puller |

EASY-CUT JAWS



- EASY-CUT JAWS
- Is a quality professionally engineered tool
 - Has a hardened steel hex end that fits into any drill chuck
 - Has a built-in spring loaded patented safety chip-guard
 - Uses a heat treated bi-metal cutter that cuts through brass, steel and plastic faucet mounting nuts
 - Works on all faucet brands that have 1/2" water supply shanks

| PART# | DESCRIPTION |
|-------|-------------|
| 7018 | Easycut |

PIPE PLUG



- For copper water pipe 1/2" to 2-1/2" diameter
- Perfect for residential, commercial, and industrial plumbing & contracting
- Cut-away pipe shows the pipe plug expanded inside the pipe
- Pipe plug allows leaky valves to be replaced & other pipe modifications made with the minimum of downtime and inconvenience! Pipe plug stops the flow of water so repairs can be made fast and easy
- No need for a separate rod for each pipe size.
- Changing from one pipe size to another is quick and simple. All of the rubber plugs & washers are nested together and secured in a convenient storage tube. Using a combination of standard fittings, the down time can be drastically reduced which allows you to quickly move on to the next job.
- Each kit includes: storage tube, rod(s) with tightening handle, adjustable stop rubber plug set, full instructions

| PART# | DESCRIPTION |
|-------|--------------------------------------|
| 59550 | Pipe plug mini, 1, 3/4, 1/2" |
| 59555 | 1/2, 3/4, 1, 1-1/4, 1-1/2, 2, 2-1/2" |

PLUMBERS TOOLS

BIG YANK HANDLE PULLER



- Removes large and small handles
- Economical yet tough
- One piece forged drive bracket
- 4" bracket width
- 5" gripper fingers

| PART# | DESCRIPTION |
|-------|------------------------|
| 4659 | Big yank handle puller |

BIG YANK SR.™ HANDLE PULLER



- The only handle puller that grips faucet handles with 3 fingers
- One piece forged drive bracket
- Notches in bracket keep fingers from sliding apart
- Engineered for the professional
- 5" gripper fingers

| PART# | DESCRIPTION |
|--------|-----------------------------|
| 4659SR | Big yank sr.™ handle puller |

XPULLER - IMPACT HANDLE



- Sliding impact handle assists in breaking free troublesome handles.

| PART# | DESCRIPTION |
|-------|-------------------------|
| 4660 | XPuller - impact handle |

QUICK SWEAT



- Flexible 24" steel cables will slide through elbows and are interchangeable with the handle to fit different size copper.
- Durable polypropylene handle will fit 1/2" thru 2" cables.
- Long lasting elastomeric plug
- Eliminates "bread" and outperforms all the rest... expensive CO2 freezing devices and copper plug tools.
- PATENT NUMBER 5,819,804

| PART# | DESCRIPTION |
|-------|---|
| 51500 | Kit including: handle & 1- each 1/2", 3/4", 1" cables |
| 51040 | Handle ONLY |
| 51012 | 1/2" cable ONLY |
| 51034 | 3/4" cable ONLY |
| 51010 | 1" cable ONLY |
| 51114 | 1-1/4" cable ONLY |
| 51115 | 1-1/2" cable ONLY |
| 51120 | 2" cable ONLY |

PLUMBERS TOOLS

L

SEAT GAUGE

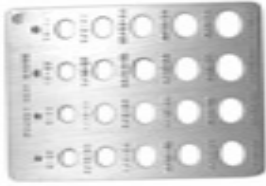

- Faucet seat gauge
- Keep in toolbox or mount in workshop
- 24 sizes

| PART# | DESCRIPTION |
|-------|-------------------|
| 11320 | Faucet seat gauge |

STEM GAUGE



- Measure sizes of faucet stems
- Keep in toolbox or workshop

| PART# | DESCRIPTION |
|-------|-------------------|
| 11325 | Faucet stem gauge |

HANDLE GAUGE, FOR MEASURING STEM BROACHES



- 21 piece set

| PART# | DESCRIPTION |
|-------|---------------------|
| 11321 | Faucet handle gauge |

AERATOR GAUGE

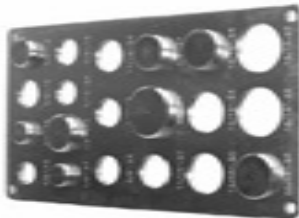

- Measures & tests threads on aerators
- 20 sizes

| PART# | DESCRIPTION |
|-------|---------------|
| 11322 | Aerator gauge |

WRENCH - CLASSIC DRAIN



- Fits 3-1/2" plastic locknuts
- Fits 3-3/8" die cast basket strainer locknuts
- Fits brass locknuts on brass shower stall drains
- Stamped shell
- 13" overall length
- Offset handle for close quarter work
- Cushion grip

| PART# | DESCRIPTION |
|-------|--------------|
| 7095 | Drain wrench |

WRENCH - PO PLUG



- Removes PO plugs and tub drains
- 6" long
- Carded for display

| PART# | DESCRIPTION |
|-------|-------------|
| 4555 | P.O. wrench |

PLUMBER'S TOOLS

PLUMBERS TOOLS

WRENCH - STRAINER NUT



- Cast strainer nut wrench
- Carded for display

| PART# | DESCRIPTION |
|-------|---------------------|
| 4569 | Strainer Nut Wrench |

WRENCH - CLOSET SEAT NUT



- Fits any length bolt
- Fits 99% of closet seat nuts, Die cast
- 3-1/2" long
- Carded for display

| PART# | DESCRIPTION |
|-------|---------------|
| 4557 | Wrench closet |

WRENCH - BASKET STRAINER



- Zinc plated steel
- Handle slides
- Carded for display

| PART# | DESCRIPTION |
|-------|-----------------|
| 4949 | Strainer wrench |

KEY - WATER METER & METER SOCKET HEAD

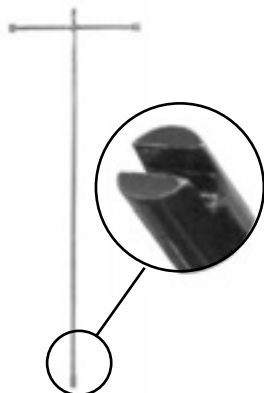

Key Water Meter

- Designed for valves that are hard to turn
- Heavy Duty
- Minimum order of 6 keys required

3/8" Slotted Key

- Designed for the City of Toronto valves

Meter Socket Head

- Make any length meter key using 1/2" IPS threaded pipe and this socket

| PART# | SHAFT | LENGTH | HANDLE |
|--------|-------|--------|--------|
| 4061 | 5/8" | 60" | 14" |
| 4061SP | 5/8" | 60" | 18" |

KEY WATER METER
PART# 4061

3/8" SLOTTED KEY
PART# 4061SP

RAMBIT FITTING SAVER



PATENT NUMBER
4,720,219

SAVES TIME

- Repairing solvent welded closet flanges
- Cut 3" and 4" DWV flush, below slab or sub-floor
- Repairing irrigation and swimming pool manifolds, sprinkler risers and freeze damaged plastic pipe

| PART# | SIZE |
|-------|--------|
| 3237 | 1/2" |
| 3239 | 3/4" |
| 3241 | 1" |
| 3242 | 1-1/4" |
| 3243 | 1-1/2" |
| 3244 | 2" |
| 3253 | 3" |
| 3254 | 4" |

PLUMBERS TOOLS, FOR LEAD

LEAD LADLES



- Cast iron lead melting ladles

| PART# | DESCRIPTION |
|-------|-------------|
| 4585 | 3" |
| 4587 | 4" |

PLUMBERS TYPE LEAD POTS



- Cast iron lead pots

| PART# | SIZE | VOLUME IN WEIGHT |
|-------|------|------------------|
| 4592 | 6" | 30 LBS. |
| 4594 | 8" | 70 LBS. |

CAULKING TOOLS



- For lead & oakum

| PART# | DESCRIPTION |
|-------|--------------------------------|
| 4442 | 5/8" x 7" inside caulker |
| 4443 | 5/8" x 7" outside caulker |
| 4444 | 5/8" x 7" straight caulker |
| 4446 | 1-1/2" curved caulker |
| 4447 | 5/8" x 12" offset yarning iron |
| 4448 | 5/8" x 16" spring yarning iron |

LEAD JOINT RUNNERS



| PART# | RUNNER SIZE | FOR SOIL PIPE SIZE |
|-------|-------------|--------------------|
| 4576 | # 1 | 2" to 4" |
| 4577 | # 2 | 4" to 6" |
| 4578 | # 3 | 6" to 10" |

LEAD MELTING FURNACE



- Accommodates 6" to 8" lead pots
- Works off direct propane cylinder pressure
- Fits 3" cylinder
- Stand converts furnace to free standing unit
- 1/4" I.P.T. connections

| PART# | DESCRIPTION |
|-------|------------------------------------|
| 4597 | Lead melting furnace without stand |
| 4599 | Stand with valve |

PLUMBERS TOOLS, GAUGES

GAUGE - LAZY HAND WATER TEST



- Dual reading dial (KPA and PSI)
- 2-1/2" dial face
- Regular pressure hand (shown at zero) pushes LAZY hand to peak operating or surge pressure point where it remains until you manually reset it
- Excellent to determine if P/T valve is leaking from failure or if leaking is caused by surge

| PART# | PSI |
|-------|--------|
| 1423 | 0-160# |
| 1428 | 0-300# |

WATER TEST GAUGE



- Dual scale dial (KPA and PSI)
- 2-1/2" dial face

| PART# | PSI |
|-------|--------|
| 1430 | 0-300# |

GAUGE - AIR TEST ASSEMBLY



- Plastic face
- All parts precision made and assembled with sealant
- 3/4" FPT
- 2" gauge

| PART# | PSI | INCREMENTS |
|-------|--------|------------|
| 1427 | 0-30# | 1/2# |
| 1421 | 0-100# | 2# |

TIRE PUMP, HEAVY DUTY



- Metal frame
- 160 PSI rated
- 20" tall
- 8" handle
- Large stabilizer base
- 24" hose

| PART# | DESCRIPTION |
|-------|-----------------------|
| 1426 | Tire pump, heavy duty |

DELUXE TIRE PUMP WITH GAUGE



- 24" flexible hose
- With quick connect nozzle
- Foot stabilized
- Chrome cylinder
- Stands 23" tall
- 7" handle
- Complete with gauge

| PART# | DESCRIPTION |
|-------|----------------------|
| 1429 | Tire pump with gauge |

PLUMBERS TOOLS



WATER SUCTION TOOL



- Suctions out the water remaining in the toilet, drain, p-trap etc.
- 9" hose standard but can be lengthened if required
- Saves time and effort over sponges
- Holds up to 10 oz of water

STRAINER WRENCH 4 IN 1



- Made of super tough LEXAN plastic
- Overall 5-1/2" long
- Fits 3/8" strainer locknut
- Slotted inserts fit sink basket strainer locknuts

| PART# | DESCRIPTION |
|-------|-------------|
| 4860 | Suction gun |

| PART# | DESCRIPTION |
|-------|-----------------|
| 4948 | Strainer wrench |

WRENCHES, SPUD



- Unique attachment for installing and removing closet and urinal spuds
- Slots in tools line up and grip the raised edges
- Includes a 3/4" x 1/2" socket adaptor

SLOAN TAILPIECE TOOL



- Fits into the SLOAN tailpiece
- Fits the raised edges and unscrew the tailpiece
- No damage to the chrome finish

| PART# | DESCRIPTION |
|-------|-------------|
| 99500 | 3/4" |
| 99501 | 1-1/4" |
| 99502 | 1-1/2" |
| 99503 | 2" |

| PART# | DESCRIPTION |
|--------|----------------|
| 992180 | Tailpiece tool |

PLUMBER'S TOOLS

PLUMBERS TOOLS

GRAB ALL TOOL



- Perfect tool for retrieving small objects
- Long bendable shaft
- 3 prong claw opening for easy pickup
- 24" long
- Heavy duty professional grade

| PART# | DESCRIPTION |
|-------|---------------|
| 4919 | Grab all tool |

WRENCH FOR FLUSH VALVES



- For chrome finishes on flush valves
- Fits ZURN, SLOAN, DELANY
- Smooth jaw wrench
- Heavy duty construction
- Replacement for ZURN WONDER WRENCH and RIDGID OFFSET WRENCH

| PART# | DESCRIPTION |
|-------|-------------------------|
| 33960 | Wrench for flush valves |

WRENCH, SOCKET NUT



- Handy tool for plastic faucet nut installation and removal
- Fits 2 and 4 lug nuts
- Overall 5" long

| PART# | DESCRIPTION |
|-------|-------------------|
| 5005 | Socket nut wrench |

STRAP WRENCH, RUBBER



- Versatile tool with many uses
- Adjustable strap
- Small and large sizes
- Fits up to 4" or 6" max size
- Flexible band adjusts to any shape

| PART# | DESCRIPTION |
|-------|-------------|
| 5010 | Small to 4" |
| 5015 | Large to 6" |

TEST PLUGS

TEST PLUG - SINGLE SURE TEST



- Maximum Back Pressure
- Air: 10 PSIG
- Water: 30FT. Hd.
- Not sold with inflation hose

| PART# | IPS SIZE | MAX DIAMETER | MAX INFLATION |
|-------------|-----------------|--------------|---------------|
| 4730 | 1-1/4" - 1-1/2" | 1-3/4" | 30 PSI |
| 4731 | 2" | 2-1/4" | 30 PSI |
| 4732 | 3" | 3-1/4" | 30 PSI |
| 4733 | 4" | 4-1/4" | 30 PSI |
| 4734 | 6" | 6-1/4" | 30 PSI |
| 4735 | 8" | 8-1/4" | 25 PSI |
| 4736 | 10" | 10-1/4" | 25 PSI |
| 4737 | 12" | 12-1/4" | 25 PSI |

TEST PLUG - LONG SURE TEST



- Maximum Back Pressure
- Air: 10 PSIG
- Water: 30FT. Hd.
- Sold with 2 ft. extension hose

| PART# | IPS SIZE | MAX DIAMETER | MAX INFLATION |
|-------------|----------|--------------|---------------|
| 4743 | 2" | 2-1/4" | 30 PSI |
| 4744 | 3" | 3-1/4" | 30 PSI |
| 4745 | 4" | 4-1/4" | 30 PSI |
| 4746 | 4" - 6" | 6-1/4" | 30 PSI |

EXTENSION HOSES



- Tire pump connections
- 1/4" Male x 1/4" Female swivel
- Any length hose can be ordered
- Please call for quote

| PART# | LENGTH |
|---------------|--------|
| 4759-2 | 2 ft. |
| 4759-3 | 3 ft. |
| 4759-4 | 4 ft. |
| 4759-5 | 5 ft. |
| 4759-6 | 6 ft. |

TEST PLUG - "SURE TEST" DUAL STAGE LONG



- Maximum back pressure
- Air: 10 PSIG
- Water: 30FT. Hd
- Two-2Ft. hoses are molded as part of the plug
- Additional hose lengths may be required
- This 2-hose plug has twin chamber construction which allows the nose of the plug to be inflated or deflated separately from the back of the plug. This dual stage, 2 hose inflation deflation plug protects the contractor from test water overflow

| PART# | IPS SIZE | MAX DIAMETER | MAX INFLATION |
|-------------|----------|--------------|---------------|
| 4739 | 2- 3" | 3-1/4" | 30 PSI |
| 4740 | 3- 4" | 4-1/4" | 30 PSI |

TEST PLUGS

TEST PLUG - NYLON EXPANSION



- LYNCAR offers a low pressure nylon test plug available from 2" to 6" sizes
- These are a superior and versatile nylon plug that accommodate a wide variety of applications
- They are shatter proof, corrosion resistant, and can be easily cleaned for long use
- All wing nut plugs when tightened will expand to seal in the pipe
- The plugs are hollow, allowing water or gas to be injected or drained as required

| PART # | SIZE | PSI |
|---------------|------|-----|
| R19027 | 2" | 30 |
| R19028 | 3" | 15 |
| R19029 | 4" | 15 |
| R19030 | 5" | 12 |
| R19031 | 6" | 10 |

DRAIN CLEANER BLADDER

**Part# 4624**

- Unclogs 1" - 2" drains
- Use for swimming pool lines, bathtubs & showers, bathroom sinks
- Works with 1-1/4" sink

Part# 4625

- Unclogs 1-1/2" - 3" drains
- Use for washing machine drains, bathtubs & showers, and kitchen sinks

Part # 4626

- Unclogs 3" - 6" drains
- Use for main drains, basement drains and outside sewer drains

| PART# | DESCRIPTION |
|-------------|----------------------------|
| 4624 | Unclogs 1" - 2" drains |
| 4625 | Unclogs 1-1/2" - 3" drains |
| 4626 | Unclogs 3" - 6" drains |

PLUMBERS TOOLS

TEST CAPS KNOCKOUT



- Solvent weld to ABS or PVC DWV pipe
- Fits both sch. 40 as well as foam core DWV
- Sold in poly bags of 100 pcs

| PART NUMBER | SIZE |
|-------------|--------|
| 4842 | 1-1/2" |
| 4843 | 2" |
| 4844 | 3" |
| 4845 | 4" |

TEST CAP & CLEAN OUT

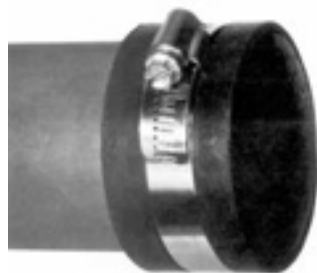

- Fits plastic and hubless cast iron DWV pipe
- Made from high quality rubber with a stainless steel clamp
- Rubber has cross rib for extra strength and inside knurling grips pipe

| PART # | SIZE |
|-------------|--------|
| 4417 | 1-1/2" |
| 4418 | 2" |
| 4419 | 3" |
| 4422 | 4" |
| 4840 | 5" |
| 4841 | 6" |

TEST PLUG - CAST IRON



- These test plugs are manufactured from cast iron, with a long test nipple and durable rubber seals

| PART# | SIZE |
|-------------|------|
| 4605 | 6" |
| 4606 | 8" |
| 4607 | 10" |
| 4608 | 12" |

TEST PLUG - WING NUT ECONOMY



- Designed with a rubber flange that grips the end of the pipe preventing slippage while tightening
- Red rubber body with plated steel top & bottom and wing nut
- 3" & 4" supplied with "Superfly" wing nut
- Use in plastic, cast iron, DWV. plumbing, pool & spa applications

| PART# | SIZE |
|-------------|--------|
| 4801 | 1" |
| 4802 | 1-1/4" |
| 4803 | 1-1/2" |
| 4804 | 2" |
| 4806 | 3" |
| 4808 | 4" |

PLUMBER'S TOOLS

SAFE-T-SEAL BY G.T. WATER

SAFE-T-SEAL TEST PLUGS FITS 1-1/4 - 2" PIPE



part#4627



part#4628



part#4629



part#4630

- G.T. WATER PRODUCTS has developed its SAFE-T-SEAL line with a concern for the consumer's safety. Test plugs are specifically used to pressure test water lines in new construction and in renovation projects.
- The SAFE-T-SEAL brand, as the name implies, has eliminated all of the negative, dangerous features associated with other major brands. SAFE-T-SEAL's distinctive features include: a safety valve to prevent over inflation or blow-out with built in pressure relief valves which are pre-set to release excess pressure through the plug valve; dual inflation capability gives the user the option of air or water; a waffle-patterned exterior to prevent the plug from slipping while in the pipe; two-stage deflation on long test plugs which eliminates back wash and flooding during deflation

| PART# | DESCRIPTION |
|-------|----------------------|
| 4627 | Fits 1-1/4 - 2" pipe |
| 4628 | Fits 3" pipe |
| 4629 | Fits 3"- 4" pipe |
| 4630 | Fits 4"-6" pipe |

TEST PLUGS & AUGERS

EXPANDABLE TEST PLUGS G.T. WATER



- Drain king, cleanout plugs
- No metal parts
- Easy to install and remove

| PART# | SIZE | OEM# |
|-------------|--------|--------|
| 4833 | 1-1/2" | MTP152 |
| 4834 | 2" | MTP202 |
| 4835 | 3" | MTP302 |
| 4836 | 4" | MTP402 |
| 4837 | 6" | MTP602 |

TEST PLUG - FLEXIBLE ALL AMERICAN



- The popular "All American" plug is made with two rubber balls and a non rusting aluminum casting
- They can easily be tightened by hand
- Flexible spring and cable
- Rubber balls provide a sure seal, and retains shape after constant use

| PART# | SIZE |
|---------------|--------|
| 4619AA | 1-1/2" |
| 4620AA | 2" |
| 4621AA | 3" |
| 4622AA | 4" |
| 4623AA | 6" |
| 4624AA | 8" |

HAND SPINNER DAHLE



- A reliable stand-by hand spinner when working with tough kitchen and bathroom sink and bath/shower drains.
- Available with either 1/4", 5/16" cable or the very robust 3/8" cable
- Cable won't slip in chuck, yet easy to tighten/loosen
- Large handle is easy to grip
- Available in Bulb Head or Drop Head versions
- Available in either 10 ft. or 20 ft. length cables

| PART# | DESCRIPTION |
|-------------------|-----------------------------|
| 982D3810 | 1/4" x 10' |
| 982D3820 | 1/4" x 20' |
| 982D40 | 5/16" x 20' with bulb auger |
| 982D4038 | 3/8" x 20' with bulb auger |
| 982D4038DH | 3/8" x 20' with drop head |
| 982D40DH | 5/16" x 20' with drop head |

AUGERS

HEAVY DUTY TOILET AUGER



- Professional quality tools available in a 3 ft. (K3) or 6 ft. length (K6)
- Ideal for quick and safe removal of obstructions in the toilet
- Specially designed to traverse tough traps
- Available with drop head or bulb head design
- Durable, 1/2" inner-core cable
- Large handles are easy to use
- Vinyl guard protects damage to toilets
- D-6 model expandable 3 ft. longer than D-3

| PART# | DESCRIPTION |
|----------------|--------------------------------|
| 981K3 | 3' toilet auger with bulb head |
| 981K3DH | 3' toilet auger with drop head |
| 981K3RB | 3' bulb replacement cable |
| 981K3RD | 3' drop head replacement cable |
| 981K6 | 6' toilet auger with bulb head |
| 981K6DH | 6' toilet auger with drop head |
| 981K6RB | 6' bulb head replacement cable |

URINAL AUGER



- Professional quality tools available in a 3 ft. (K3) or 6 ft. length (K6)
- Ideal for quick and safe removal of obstructions in the toilet
- Specially designed to traverse tough traps
- Available with Drop Head or Bulb Head design
- Durable, 1/2" inner-core cable
- Large handles are easy to use
- Vinyl guard protects damage to toilets
- D-6 model expandable 3 ft. longer than D-3

| PART# | DESCRIPTION |
|---------------|------------------------------------|
| 981D2 | 29" with bulb head |
| 981D4C | 4' inner core cable with bulb head |

STANDARD TOILET AUGER



- Professional quality tools available in a 3 ft. (K3) or 6 ft. length (K6)
- Ideal for quick and safe removal of obstructions in the toilet
- Specially designed to traverse tough traps
- Available with Drop Head or Bulb Head design
- Durable, 1/2" inner-core cable
- Large handles are easy to use
- Vinyl guard protects damage to toilets
- D-6 model expandable 3 ft. longer than D-3

| PART# | DESCRIPTION |
|---------------|--------------------------------|
| 981D1 | 3' x 3/8" cable with bulb head |
| 981D4H | 3' x 1/2" cable with bulb head |

AUGERS

AUGER - CANISTER TYPE



- 3/8"
- Spin thru augers
- Quality economy model
- 15 & 25 foot lengths

| PART# | DESCRIPTION |
|--------------|-------------|
| 15100 | 15 ft |
| 15105 | 25ft |

AUGER - CANISTER DRILL DRIVEN



- 3/8"
- Spin thru augers with drill attachment
- Quality economy model
- 15 & 25 foot lengths

| PART# | DESCRIPTION |
|--------------|-------------|
| 15115 | 15 ft |
| 15120 | 25ft |

AUGER - CLOSET



- Steel tube closet auger
- Quality economy model
- 3 foot length

| PART# | DESCRIPTION |
|--------------|-------------|
| 15110 | 3 ft |

AUGER - ZIP PLASTIC MINI SNAKE



- Quickly unclogs sinks, showers and bath drains
- Retail packaged
- No mess!
- No chemicals!
- Strong resin

| PART# | DESCRIPTION |
|--------------|-------------|
| 15125 | Mini snake |

PLUNGERS

FORCE CUP PLUNGER



- High quality red rubber
- Available in 5" & 6" diameters
- 19" Wood Handle

PLUNGER HEAVY DUTY BOWL FORCE CUP



- Extra large for best pressure with positive seal
- Designed for all types of toilets
- High quality black rubber
- Big bell for big jobs
- 19" Wood Handle

PART# CUP SIZE

| | |
|------|--------|
| 4640 | 5" cup |
| 4641 | 6" cup |

PART# DESCRIPTION

| | |
|------|-------------------------------|
| 4637 | Plunger heavy duty, force cup |
|------|-------------------------------|

SINK PLUNGER, KITCHEN



- 4" diameter cup
- 9" wood handle

PLUNGER - DUAL BLAST FORCE CUP



- High quality rubber
- 19" wood handle
- Bell shape provides positive seal
- Dual action works well on sinks and wash basins, etc

PART# DESCRIPTION

| | |
|------|--------------------------------------|
| 4639 | High quality red rubber, for kitchen |
|------|--------------------------------------|

PART# DESCRIPTION

| | |
|------|------------|
| 4638 | Dual blast |
|------|------------|

PLUNGER - FUNNELED NOSE



- Sold in 12pcs. display pack only
- Funneled nose
- 162 cubic inch displacement
- More plunge per push
- Won't skid
- Fit all toilet bowls

PLUNGER - MASTER PLUMBER'S FORCE CUP



- Heavy duty
- Ribbed cup for strength
- Provides big blast for all stoppages
- High quality rubber
- 19" wood handle

PART# DESCRIPTION

| | |
|------|-----------|
| 4642 | Dark blue |
|------|-----------|

PART# DESCRIPTION

| | |
|------|----------------------|
| 4636 | Professional plunger |
|------|----------------------|

PLUMBERS TOOLS

L

NO-HUB TORQUE WRENCH



- Measures torque when turned in a clockwise direction & ratchets when turned counterclockwise
- When the brand screw is tightened to the correct torque, the wrench ratchets so the handle will continue to turn but the drive socket will not
- Retractable reversing lever
- Chrome vanadium socket for 5/16" Hex head screw
- 6" Long
- Torques to 60 inch lbs.

| PART# | DESCRIPTION |
|-------|---------------------|
| 7020 | Chrome plated brass |

ANTIFREEZE TESTER



- LYNCAR's antifreeze tester (refractometers) is high quality, impact resistant and comes in its own carrying case
- Provides accurate direct reading in both fahrenheit and centigrade of glycol coolants

| PART# | DESCRIPTION |
|--------|---------------------|
| 996055 | Chrome plated brass |

WRENCH - STRAP



- Will not mar chrome, fittings and nipples
- Nylon strap

| PART# | DESCRIPTION |
|-------|-------------|
| 4542 | 7" |
| 4543 | 11" |

CANE ROD PLUNGER



Builds up pressure of water which forces obstruction clear.

- Used to build up water pressure in pipes & flush through any blockages that may have occurred
- Main uses: unblocking main stacks, floor drains, vents & outside downspout drain stock
- The traditional rods use the best quality imported cane that is carefully selected for uniformity & consistency
- It is assembled with high quality solid brass joints that are securely fitted to the rods with brass rivets

| PART# | DESCRIPTION |
|--------|---|
| 99440 | 36" long cane rods (3 pack) |
| 99441 | Rubber plunger head assembly |
| 99441D | Rubber plunger disc replacement rubber only |

PLUMBER'S TOOLS

L

NOTES

PLUMBER'S TOOLS

SECTION "M" TRADESMEN'S TOOLS INDEX

| | | | |
|------------------------------|------|------------------------------|------|
| Adjustable Wrenches | M-3 | Leader Bits - Lenox | M-32 |
| Aluminum Pipe Wrenches | M-1 | LENOX - Arbors | M-34 |
| Arbor Pilot Drills | M-35 | LENOX - Band Saw Blades | M-31 |
| Arbors - Lenox | M-34 | LENOX - Bi Metal Blades | M-28 |
| Band Saw Blades | M-31 | LENOX - Gold Series Blades | M-28 |
| Beam Clamp Wrench | M-12 | LENOX - Hole Saw Kits | M-35 |
| Bi Metal Blades | M-28 | LENOX - Hole Saws | M-33 |
| Blades - Bi Metal | M-28 | LENOX - Jig Saw Blades | M-31 |
| Blades - Hacksaw | M-25 | LENOX - Veri Bit Drill Bits | M-31 |
| Blankets -Solder | M-7 | Levels | M-21 |
| Bolt Cutters | M-2 | Lighter - Spark | M-7 |
| Bulbs - Flashlights | M-22 | Locking Pliers | M-3 |
| Cable Saw | M-27 | MAXPOWER Adjustable Wrenches | M-3 |
| Carbide Bi-Metal Blades | M-20 | MAXPOWER Pipe Wrenches | M-1 |
| Carbide Hole Saws | M-20 | MAXPOWER Tri Stand | M-36 |
| Carbide Hole Saws - Lenox | M-33 | Mini Hacksaws | M-27 |
| Caulking Guns | M-24 | Nipple Extractors | M-5 |
| Caulking Screening Set | M-24 | Nipple Wrenches | M-5 |
| Chalk Refills | M-22 | Nut Drivers | M-12 |
| Copper Pipe Bending Kit | M-19 | Nut Setter Tool | M-11 |
| Copper Sizing Tools | M-17 | On Centre Tool | M-21 |
| Cord Organizer | M-23 | One Tooth Hole Saws | M-32 |
| Cutters - Pipe | M-15 | Pier - Channellock | M-8 |
| Cutters - Threading Machines | M-15 | Pier - Lineman's | M-10 |
| Cutters - Tubing | M-13 | Pier - Locking | M-3 |
| Cutters - Zip Action Tubing | M-13 | Pier - Plumbers | M-2 |
| Deburrer - Plastic Pipe | M-19 | Pier - Tongue & Groove | M-9 |
| Deburring Tool - Copper | M-18 | Pier- Wire Hose | M-9 |
| Drill Bits - Veri Bit Lenox | M-31 | Pier - WITCO | M-10 |
| Drill Sets | M-20 | Pipe Cutters | M-15 |
| Drills - Pilot | M-35 | Pipe Cutting Wheels | M-16 |
| Easy Bend Kit - Copper Pipe | M-19 | Pipe Freezing Kits | M-36 |
| Extension Cords | M-23 | Pipe Shooter | M-26 |
| Flame Blankets | M-7 | Pipe Taps | M-20 |
| Flare Punches - Copper Tube | M-18 | Pipe Wrench Parts | M-4 |
| Flaring Tools | M-19 | Plumb Bobs | M-21 |
| Flashlights | M-22 | Plumb Line Chalk | M-22 |
| Guns - Caulking | M-24 | Plumbers Pier | M-2 |
| Hacksaw - Lenox | M-25 | PVC / ABS Inside Cutter | M-26 |
| Hacksaw Blades | M-25 | PVC / ABS Saws | M-26 |
| Hacksaws | M-25 | Rack Straps | M-6 |
| Hex Keys | M-19 | Ratchet Wrench | M-12 |
| Hole Saw - Carbide | M-20 | Rod Cutter - MAXPOWER | M-16 |
| Hole Saw Kits | M-35 | Roll Groover- MAXPOWER | M-15 |
| Hole Saws | M-33 | Roll Groover - Mini Pace | M-17 |
| Jig Saw Blades | M-31 | Rubber Tie Downs | M-6 |
| Keys - Hex | M-19 | Saw - PVC | M-26 |
| Knife - Disposable | M-11 | Saw Mini - Tri Fold | M-27 |
| Knife - Utility | M-11 | Scissors - Utility | M-11 |

MAXPOWER PIPE WRENCHES & TOOLS

ALUMINUM PIPE WRENCHES

MAXPOWER



Combining Durability & Light Weight

MAXPOWER aluminum pipe wrenches weigh up to 40% less than cast iron, yet stand up to heavy-duty industrial piping jobs.

- One piece housing with I-beam handle offers comfort and ease of use spring combine for easy ratchet action
- Uses the same induction and flame hardened heel and hook jaws as our cast iron handle pipe wrenches known brands
- Manufactured to meet government specification GGGW-651-E, Type II, Class C

| PART# | SIZE | RIDGID | SUPER EGO |
|---------------|------|--------|-----------|
| MP1210 | 10" | 31090 | 1041000 |
| MP1214 | 14" | 31095 | 1041400 |
| MP1218 | 18" | 31100 | 1041800 |
| MP1224 | 24" | 31105 | 1042400 |
| MP1236 | 36" | 31110 | 1043600 |
| MP1248 | 48" | 31115 | 1044800 |

STRAIGHT PIPE WRENCHES STEEL

MAXPOWER



- Cast iron handle
- Outstanding quality AND great value
- Handles the toughest piping jobs
- One piece housing with I-beam handle offers comfort and ease of use
- The forged jaw hook, coil and flat spring combine for easy ratchet action
- Heel and hook jaws are induction and flame hardened, then ground to a smooth surface
- Interchangeable with most well known brands
- Manufactured to meet government specification GGG-W-651-E and ANSI B-107

| PART# | SIZE | RIDGID | SUPER EGO |
|---------------|------|--------|-----------|
| MP1008 | 8" | 31005 | 1020800 |
| MP1010 | 10" | 31010 | 1021000 |
| MP1012 | 12" | 31015 | 1021200 |
| MP1014 | 14" | 31020 | 1021400 |
| MP1018 | 18" | 31025 | 1021800 |
| MP1024 | 24" | 31030 | 1022400 |
| MP1036 | 36" | 31035 | 1023600 |
| MP1048 | 48" | 31040 | 1024800 |

TRADESMEN TOOLS

END PIPE WRENCHES, STEEL



- MAXPOWER pipe wrenches will handle the toughest piping jobs

| PART# | SIZE | RIDGID | SUPER EGO |
|--------|------|--------|-----------|
| MP1110 | 10" | 31060 | 1121000 |
| MP1114 | 14" | 31070 | 1121400 |
| MP1118 | 18" | 31075 | NA |

OFFSET ALUMINUM PIPE WRENCHES



- Combines durability & light weight
- MAXPOWER's 90° offset pipe wrenches are extremely popular because they are over 40% lighter than similar cast iron models
- Where other models have no clearance, this design allows work on pipes close to the wall
- Jaws are parallel to handle allowing tool to fit in tight areas

| PART# | SIZE | RIDGID | SUPER EGO |
|--------|------|--------|-----------|
| MP1314 | 14" | 31120 | 1051400 |
| MP1318 | 18" | 31125 | 1051800 |
| MP1324 | 24" | 31130 | NA |

PIPE OR PLUMBERS PLIER



- Box joint pliers
- Black phosphate finished
- PVC dipped handle

Compares to
- ROTHENBERGER # 70522
- SUPER EGO # 5221000

| PART# | SIZE |
|-------|------|
| 6008 | 10" |
| 6009 | 12" |

BOLT CUTTERS



| PART# | REPLACEMENT HEAD ASSEMBLY | SIZE |
|----------|---------------------------|------|
| 99BC0708 | 99BC0708B | 8" |
| 99BC0712 | 99BC0712B | 12" |
| 99BC0714 | 99BC0714B | 15" |
| 99BC0718 | 99BC0718B | 18" |
| 99BC0724 | 99BC0724B | 24" |
| 99BC0730 | 99BC0730B | 30" |
| 99BC0736 | 99BC0736B | 36" |
| 99BC0742 | 99BC0742B | 42" |

TRADESMEN TOOLS

CURVED JAWS PLIERS



- Curved jaws with wire cutters nickel plated
- Premium quality

| PART# | SIZE |
|-------|------|
| 4580 | 5" |
| 4581 | 7" |
| 4582 | 10" |

LONG NOSE JAWS PLIERS



- Long nose plier, with wire cutter
- Nickel plated
- Premium quality

| PART# | SIZE |
|-------|------|
| 4583 | 7" |
| 4584 | 9" |

ADJUSTABLE WRENCH



- MAXPOWER manufactures more adjustable wrenches than anyone in the world
- As the world's leading manufacturer, they deliver top quality, value and innovation
- The MAXPOWER factory has been ISO-9001 certified since 1996
- Adjustable wrenches exceed ANSI-ASME B107/ 8M-1991 Standards, metallurgy standards and government torque tests
- Chrome Vanadium & Black Phosphate, Red dipped handle
- Easy to read scale, in inches, just below jaws
- Available in chrome plated, black phosphate or coated dipped (red) handle

| PART# | LENGTH | FINISH |
|---------|--------|-------------------|
| MP204 | 4" | Chrome plated |
| MP206 | 6" | Chrome plated |
| MP208 | 8" | Chrome plated |
| MP210 | 10" | Chrome plated |
| MP212 | 12" | Chrome plated |
| MP215 | 15" | Chrome plated |
| MP218 | 18" | Chrome plated |
| MP224 | 24" | Chrome plated |
| MP104 | 4" | Black phosphate |
| MP106 | 6" | Black phosphate |
| MP108 | 8" | Black phosphate |
| MP110 | 10" | Black phosphate |
| MP112 | 12" | Black phosphate |
| MP115 | 15" | Black phosphate |
| MP118 | 18" | Black phosphate |
| MP6004 | 4" | Red coated handle |
| MP6006 | 6" | Red coated handle |
| MP6008 | 8" | Red coated handle |
| MP60010 | 10" | Red coated handle |
| MP60012 | 12" | Red coated handle |
| MP60015 | 15" | Red coated handle |

PIPE WRENCH REPLACEMENT PARTS

HEEL JAW & PIN ASSEMBLY

Interchangeable with: RIDGID, SUPER EGO, BERKLEY, ROTHENBERGER, STANLEY



| PART# | SIZE | REPLACES RIDGID | REPLACES SUPER EGO |
|--------|------|-----------------|--------------------|
| MP1508 | 8" | 31585 | 1020815 |
| MP1510 | 10" | 31610 | 1021015 |
| MP1512 | 12" | 31635 | 1021215 |
| MP1512 | 14" | 31635 | 1021415 |
| MP1518 | 18" | 31675 | 1021815 |
| MP1524 | 24" | 31700 | 1022415 |
| MP1536 | 36" | 31725 | 1023615 |
| MP1548 | 48" | 31750 | 1044815 |

HOOK JAW

Interchangeable with: RIDGID, SUPER EGO, BERKLEY, ROTHENBERGER, STANLEY



| PART# | SIZE | REPLACES RIDGID | REPLACES SUPER EGO |
|--------|------|-----------------|--------------------|
| MP1408 | 8" | 31580 | 1020802 |
| MP1410 | 10" | 31605 | 1021002 |
| MP1412 | 12" | 31630 | 1021202 |
| MP1414 | 14" | 31655 | 1021402 |
| MP1418 | 18" | 31670 | 1021802 |
| MP1424 | 24" | 31695 | 1022402 |
| MP1436 | 36" | 31720 | 1023602 |
| MP1448 | 48" | 31745 | 1044802 |

COIL & FLAT SPRING

Interchangeable with: RIDGID, SUPER EGO, BERKLEY, ROTHENBERGER, STANLEY



| PART# | SIZE | REPLACE RIDGID | REPLACES SUPER EGO |
|--------|------|----------------|--------------------|
| MP1708 | 8" | 31590 | 1020813 |
| MP1710 | 10" | 31620 | 1021013 |
| MP1712 | 12" | 31640 | 1021213 |
| MP1714 | 14" | 31660 | 1021413 |
| MP1718 | 18" | 31680 | 1021813 |
| MP1724 | 24" | 31705 | 1022413 |
| MP1736 | 36" | 31730 | 1023613 |
| MP1748 | 48" | 31755 | 1044813 |

WRENCH NUT

Interchangeable with: RIDGID, SUPER EGO, BERKLEY, ROTHENBERGER, STANLEY



| PART# | SIZE | REPLACES RIDGID | REPLACES SUPER EGO |
|--------|------|-----------------|--------------------|
| MP1608 | 8" | 31595 | 1020804 |
| MP1610 | 10" | 31615 | 1021004 |
| MP1612 | 12" | 31645 | 1021204 |
| MP1614 | 14" | 31665 | 1021404 |
| MP1618 | 18" | 31685 | 1021804 |
| MP1624 | 24" | 31710 | 1022404 |
| MP1636 | 36" | 31760 | 1023604 |
| MP1648 | 48" | 31765 | 1044804 |

TRADESMEN TOOLS

PLUMBER'S EXTRACTOR KIT



- Extract broken bolts quickly
- Carded for display
- 5pcs 1/8", 1/4", 3/8", 1/2", 3/4"

| PART# | DESCRIPTION |
|-------|---------------------------------|
| 52501 | Plumber's 5 piece Extractor kit |

WRENCH - INTERNAL NIPPLE



- CAM type
- Removes or inserts
- Heat treated
- Cadmium plated

| PART# | DESCRIPTION |
|-------|-------------|
| 4530 | 3/8" |
| 4531 | 1/2" |
| 4532 | 3/4" |
| 4533 | 1" |

INTERNAL NIPPLE WRENCH DELUXE

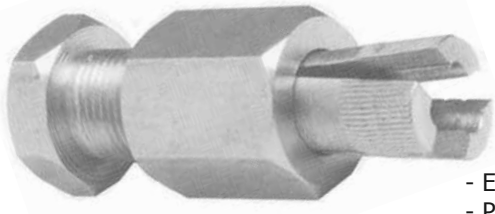

- Excellent for chrome work
- Precision machined and hardened
- Loosens and tightens
- Designed to grip internally the smallest area of a nipple
- Removes broken nipple threads from fittings

| PART# | DESCRIPTION |
|-------|-------------|
| 4511 | 1/2" IPS |
| 4512 | 3/4" IPS |
| 4513 | 1" IPS |

NIPPLE & SCREW EXTRACTORS



- Removes nipples, bolts and screws
- Left hand spiral tapered flute removes broken piece without thread damage

| PART# | IND ID# | TRADE SIZE | DRILL SIZE | BOLT SCREW SIZE |
|-------|---------|------------|------------|-----------------|
| 4827 | 4 | 1/8" | 1/4" | 45/64" |
| 4828 | 5 | 1/4" | 19/64" | 59/64" |
| 4829 | 6 | 3/8" | 13/32" | 1-5/32" |
| 4830 | 7 | 1/2" | 17/32" | 1-1/2" |
| 4831 | 8 | 3/4" | 13/16" | 1-47/64" |
| 4832 | 9 | 1" | 1-1/16" | 2-7/32" |

TRADESMEN TOOLS

RACK STRAP



- Solid steel construction.
- Zinc plated and yellow chromate finished for weather and salt protection
- Polyester strap is 7 feet long and 1-1/2" wide, UV protected and water resistant

| PART# | DESCRIPTION |
|-------|--|
| 99RS | Right angle mounting bracket for square tube racks fits racks built by ADRIAN STEEL, CROSS, TREADS, LEER, TRUCK RACK COMPANY, VANGUARD, WEATHERGUARD, and many others. |
| 99RS4 | Curved mounting bracket for 1-5/8" O.D. round pipe fits racks built by BLACKMAX, VANGUARD and other custom racks. |
| 99SK | Replacement arm |

TIE DOWN STRAPS



- Warning label attached
- Superior quality rubber tie down straps
- Natural rubber & EDPM rubber blend
- Extra material around hooks
- Tensile strength 130kg/285 lbs

| PART# | LENGTH | LENGTH STRETCHED |
|-------|--------|------------------|
| 4901 | 9" | 14" |
| 4903 | 15" | 20" |
| 4905 | 20" | 25" |
| 4907 | 31" | 36" |
| 4909 | 41" | 46" |

TRADESMEN TOOLS

FLAME-GUARD



- Protects wood, painted or metal surfaces from the heat and flame of a torch!
- Designed for soldering and brazing using propane and MAPP gas

| PART# | SIZE |
|-------|-----------|
| 59500 | 9" x 12" |
| 59501 | 24" x 24" |

FLAME BLANKET EXTRA HEAT



- Flame-blanket protects wood, painted or metal surfaces from the heat and flame of a torch!
- Designed for soldering and brazing using propane and MAPP gas
- You can't buy a more durable or longer lasting flexible heat & flame protective product
- No toxic smoke

| PART# | DESCRIPTION |
|-------|-------------|
| 59502 | 12" x 12" |
| 59503 | 9" x 12" |

LIGHTER SPARK



- Round, single, or triple flint
- Large hood traps more gas
- File has keen cutting surface
- File rotates providing a fresh surface for the flint
- Flints good for 1,500 ignitions

| PART# | DESCRIPTION | PACKAGE |
|-------|------------------|---------|
| 4430 | Lighter complete | 12 |
| 4432 | Extra flints | 5 |

LIGHTER - SHURLITE SPARK



- Round, single, or triple flint
- Large hood traps more gas
- File has keen cutting surface
- File rotates providing a fresh surface for the flint
- Flints good for 1,500 ignitions

| PART# | DESCRIPTION | PACKAGE |
|-------|------------------|---------|
| 4437 | Lighter complete | 12 |
| 4438 | Extra Flints | 3 |

TIN SNIPS



- Hand guards
- Cushion grips
- Forged blades
- Edges honed
- Size 10"
- Cut 1-1/2"

| PART# | DIRECTION OF CUT |
|-------|------------------|
| 4340 | Left |
| 4341 | Right |
| 4342 | Straight |

TRADESMEN TOOLS

WIRING TOOL CHANNELLOCK



- Strips wire with no damage to conductor
- Crimps both insulated and non-insulated wire

| PART# | DESCRIPTION |
|-------|-------------|
| C908 | 8-1/4" long |

PLIER - DIAGONAL CUTTER CHANNELLOCK



- Lap joint plier
- Polished high carbon drop forged steel
- Perfectly mated cutter, heat treated to hold it's edge

| PART# | DESCRIPTION |
|-------|------------------|
| C337 | Diagonal cutting |

PLIER - LINEMANS



- Polished high carbon drop forged steel
- Perfectly mated cutter, heat treated to hold it's edge

| PART# | DESCRIPTION |
|-------|-------------|
| C317 | 7-1/2" long |

PLIER - PLUMBERS HELPER CHANNELLOCK



- Heavy duty construction
- Perfectly mated cutters, scientifically heat treated to hold its edge
- Round nose design
- Enclosed-joint design holds cutters in perfect alignment for the life of the plier

| PART# | DESCRIPTION |
|-------|-------------------------|
| C349 | Plier Linemans 9" plier |

PLIER - GRIPLOCK CHANNELLOCK



- Ergonomically designed offset head for greater leverage
- Patented PermaLock® fastener eliminates nut and bolt failure
- CHANNELLOCK BLUE comfort grips.

| PART# | LENGTH | ADJ | CAP |
|-------|--------|-----|--------|
| CGL6 | 6" | 5 | 1-1/4" |
| CGL10 | 10" | 5 | 1-3/4" |
| CGL12 | 12" | 6 | 2-7/8" |

TRADESMEN TOOLS

PLIER TONGUE & GROOVE CHANNELLOCK

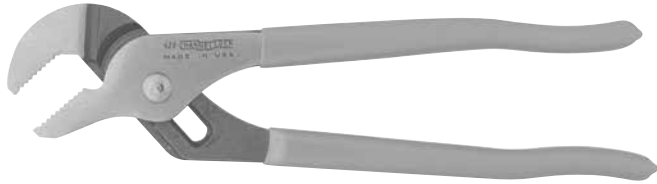

- Right angle teeth grip in all directions for maximum bite and minimum wear.
- Patented undercut tongue and groove design assures no slip jaw action.
- Patented reinforcing edge minimizes stress breakage.
- Patented PermaLock® fastener eliminates nut and bolt failures.
- Distinctive CHANNELLOCK BLUE comfort grips

| PART# | LENGTH | ADJ | CAP |
|-------------|---------|-----|--------|
| C420 | 9-1/2" | 5" | 1-1/2" |
| C426 | 6-1/2" | 5" | 7/8" |
| C430 | 10" | 7" | 2" |
| C440 | 12" | 7" | 2-1/4" |
| C460 | 16" | 8" | 4-1/4" |
| C480 | 20-1/4" | 12" | 5-1/2" |

PLIER - CURVED JAW CHANNELLOCK



- Curved jaw for use on round stock and tubing
- Right angle teeth grip in all directions for maximum bite and minimum wear.
- Patented undercut tongue and groove design assures no slip jaw action.
- Patented reinforcing edge minimizes stress breakage.
- Patented PermaLock® fastener eliminates nut and bolt failures.
- Distinctive CHANNELLOCK BLUE comfort grips

| PART # | LENGTH | ADJ | CAP |
|-------------|--------|-----|--------|
| C422 | 9-1/2" | 5" | 1-1/2" |
| C442 | 12" | 7" | 2-1/4" |

PLIER - WIRE HOSE CLAMP CHANNELLOCK



- Heavy-duty design for industrial use
- Cross hatching on jaws grabs work tightly
- Precision made of fine polished, high carbon drop forged steel.
- Patented PermaLock® fastener eliminates nut and bolt failures.
- CHANNELLOCK BLUE® comfort grips.

| PART# | LENGTH |
|-------------|--------|
| C558 | 8" |

TRADESMEN TOOLS

PLIER - LINEMANS SIDE CUTTERS



- Vinyl grip handles
- Polished head
- Honed by hand
- Standard duty

| PART# | LENGTH |
|-------|-------------------|
| 4101 | 7" plier linemans |

WIRE STRIPPER



- Adjusting stop on the gripping handles permits adjustment for wire size
- Vinyl grip handles

| PART# | DESCRIPTION |
|-------|---------------|
| 4107 | Wire stripper |

ANGLE NOSE SLIP JOINT PLIER WITCO



- Easily fit 1-1/2" slip joint nuts
- Forged and chromed
- Vinyl grip handles

| PART# | LENGTH |
|-------|--------|
| 4062 | 6-3/4" |
| 4065 | 8" |
| 4063 | 10" |

SMOOTH JAW ANGLE NOSE SLIP JOINT PLIER WITCO



- Smooth jaw plier for gripping plated fittings
- Satin chrome finish
- Vinyl grip handles

| PART# | DESCRIPTION |
|-------|-------------|
| 4064 | 10" |

TRADESMEN TOOLS

UTILITY SCISSORS



- Versatile, rugged, and multipurpose, these Utility Scissors feature stainless steel offset blades and molded plastic handles for a firm comfortable grip
- Your hands are always positioned above the materials for safer cutting.
- These scissors are powerful enough to cut most metals, yet great for tapes, wire, plastics
- Their handy 7" size make them a great addition to the contractors tool box

| PART# | DESCRIPTION |
|-------|---------------------|
| 4572 | Utility scissors 7" |

KNIFE - DISPOSABLE UTILITY



- 8 part breakaway blade
- Disposable
- Plastic case
- Metal blade
- 6" long

| PART# | DESCRIPTION |
|-------|--------------------|
| 4322 | Knife - disposable |

KNIFE - UTILITY



- Utility knife is retractable
- Blades are heavy duty, universal size and are reversible for extra life
- Carded for display

| PART# | DESCRIPTION |
|-------|------------------------------|
| 4323 | Utility knife with blades |
| 4325 | 5 pack of replacement blades |

KNIFE - UTILITY HEAVY DUTY

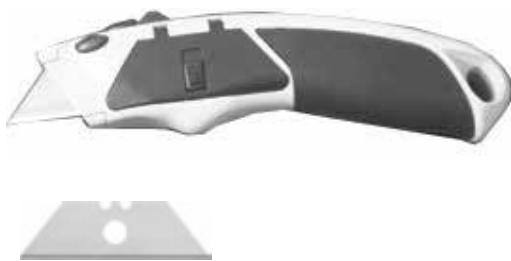

- Auto loading utility knife
- Zinc die casting body with rubber grip with 8pc blade
- Carded for display

| PART# | DESCRIPTION |
|-------|--|
| 4326 | Utility knife - heavy duty with blades |
| 4325 | 5 pack of replacement blades |

NUT SETTER



- Use with 1/4" drill to drive hex sheet metal and anchor screws
- Magnetic socket and heat treated
- 1/4" drill shank
- 1-3/4" length

| PART# | DESCRIPTION |
|-------|-------------|
| 1594 | 1/4" |
| 1595 | 5/16" |

TRADESMEN TOOLS

NUT DRIVERS



- LYNCAR nut drivers
- High quality contractor grade
- Card packaged each
- Item 4124 is a box set of 7 pieces

| PART# | DESCRIPTION |
|-------|-------------|
| 4125 | 3/16" |
| 4127 | 1/4" |
| 4129 | 5/16" |
| 4130 | 11/32" |
| 4131 | 3/8" |
| 4132 | 7/16" |
| 4133 | 1/2" |

BEAM CLAMP WRENCH



- A specialty made ratchet wrench for easy installation of beam clamps

| PART# | DESCRIPTION |
|-------|-------------------|
| 9955 | Beam clamp wrench |

WRENCH - RATCHETING BOX



- OFFSET
- Opening 12 pt.

| PART# | TYPE | SIZE | LENGTH |
|-------|----------|--------------|--------|
| 4497 | Offset | 3/8" x 7/16" | 8" |
| 4491 | Straight | 3/8" x 7/16" | 5-1/2" |
| 4492 | Straight | 1/2" x 9/16" | 6-3/4" |
| 4494 | Straight | 5/8" x 3/4" | 6-3/4" |
| 4495 | Straight | 3/4" x 7/8" | 6-3/4" |
| 4496 | Straight | 1/2" x 7/16" | 6-3/4" |

MULTI BIT SCREWDRIVER 19 IN 1 RATCH STYLE



| Square | Phillips | Hex | Hex | Slotted | Nut Driver |
|--------|----------|---------|---------|---------|------------|
| □ #0 | ⊕ #1 | ⦿ 5/64" | ⦿ 5/32" | ▬ 3/16" | ⦿ 1/4" |
| □ #1 | ⊕ #2 | ⦿ 3/32" | ⦿ 3/16" | ▬ 1/4" | ⦿ 5/16" |
| □ #2 | ⊕ #3 | ⦿ 1/8" | ⦿ 1/4" | ▬ 5/16" | ⦿ 7/16" |
| □ #3 | | | | | |

- Blister packaged
- Great counter seller
- Robertson bits, nut drivers

| PART# | DESCRIPTION |
|-------|---------------------|
| 4200 | 19 in 1 screwdriver |

TRADESMEN TOOLS

MINI TUBING CUTTER



- Good quality DIY mini cutter
- Cuts 1/8" to 7/8"
- Compare to RIDGID #103

| PART# | DESCRIPTION |
|-------|--------------|
| 4351 | Mini cutter |
| 4349 | Cutter wheel |

WIDE MOUTH MINI TUBING CUTTER



- For cutting copper, brass, aluminum, thin-walled steel tubing as well as PVC, synthetic resin and plastic sleeved tubing
- Convenient shape with very small working radius (42 mm) facilitating work in confined spaces and on parallel tubing.
- Large knurled wheel for effortless pressure adjustment.
- Twin grooved rollers for cutting close to flared ends.
- Good quality professional mini cutter
- Cuts 1/8 to 1 1/8"
- Compare to SUPER EGO 728 and RIDGID #101

| PART# | DESCRIPTION |
|-------|-------------------|
| 4353 | Wide mouth cutter |
| 4349 | Cutter wheel |

STANDARD TUBING CUTTER



- Sturdy body for DIY or service use
- Grooved roller
- Cuts 1/8" to 1-1/8" tubing
- Retractable Deburring tool attached
- Compare to SUPER EGO 725 or RIDGID #10

| PART# | DESCRIPTION |
|-------|------------------------|
| 4350 | Standard tubing cutter |
| 4349 | Cutter wheel |

LYNCAR ZIP ACTION TUBE CUTTER



- Professional duty zip-action tube cutter!
- Four Roller top support
- Cuts 1/4" to 2 1/2"
- One wheel for copper & one wheel for plastic
- Deburring tool attached
- Compare to SUPER EGO 750, RIDGID 152, ROTHENBERGER R70030
- Fast ratchet smooth action telescopic tube cutter for cutting copper, plastic, brass, aluminum and thin walled steel tubing.

| PART# | DESCRIPTION |
|--------|--------------------------|
| 4354 | Cutter |
| 4352WP | Cutter wheel for plastic |
| 4352W | Cutter wheel for copper |

TRADESMEN TOOLS

TUBING CUTTER, BEARING TYPE, TELESCOPIC



- Bearing action for ease of use
- Professional duty telescopic tube cutter!
- Four roller top support
- Cuts 1/8" to 1-5/8"
- Deburring tool stored in frame
- Carded packaging
- Professional quality

| PART# | DESCRIPTION |
|--------|---|
| 4359 | Tubing cutter, bearing type, telescopic |
| 4352WP | Wheel for plastic |
| 4352W | Wheel for copper |

LYNCAR TUBE CUTTER HD38



- Professional duty telescopic tube cutter!
- Four roller top support
- Cuts 1/8" to 1-5/8"
- Deburring tool stored in frame
- Compare to SUPER EGO 735, RIDGID 150L, ROTHENBERGER R70027
- Carded packaging

| PART# | DESCRIPTION |
|--------|-------------------|
| 4352 | Cutter |
| 4352WP | Wheel for Plastic |
| 4352W | Wheel for Copper |

TUBE CUTTERS LENOX



- Four roller tracking system keeps tube from threading
- Will not damage cutting wheels
- Full-stop feed system prevents wheels and rollers from coming into contact
- Professional deburring
- Cleanly and easily deburr pipes with the replaceable machinist's reamer

| PART# | TYPE | DESCRIPTION |
|--------|--------------------------|--|
| L21010 | Tubing cutter | 1/8" - 1-1/8" |
| L21011 | Tubing cutter | 1/8" - 1-3/8" |
| L21012 | Tubing cutter | 1/8" - 1-3/4" |
| L21013 | Tubing cutter | 1/4" - 2-5/8" |
| L21015 | Replacement cutter wheel | For aluminum, brass, copper, thin wall steel |
| L21016 | Replacement cutter wheel | For plastic/PVC |
| L21017 | Replacement cutter wheel | For copper and aluminum |

HANDY TUBING CUTTER



- For copper & plastic
- Clip on & rotate

| PART# | DESCRIPTION |
|-------|-------------------------------------|
| 4362 | Cuts 1/2" |
| 4362W | Extra wheels for part#4362 (3 pack) |
| 4363 | Cuts 3/4" |
| 4363W | Extra wheels for part#4363 (3 pack) |

TRADESMEN TOOLS

PIPE CUTTERS - METAL FOR BERKLEY & RIDGID



- Malleable iron frames for durability
- Wide rollers help ensure blade tracking
- Rollers can be removed and replaced with blades to speed cutting
- Replaceable cutter wheels which can be selected to suit the application
- BT-30033 is designed to fit the BERKLEY BT-5020/MP50301 power drive as well as the RIDGID™ model No. 300 and 55
- BT-50000 is a hand cutter designed to cut pipe up to 2" diameter

| PART# | RIDGID X-REF | DESCRIPTION |
|---------|--------------|--------------------------|
| BT30033 | 42370 | Power drive cutter |
| BT60000 | 34775 | Roller wheel 1-2" cap. |
| BT60002 | 34780 | Cutter wheel pin |
| BT60003 | 34785 | Roller wheel 2-1/2" - 6" |
| BT60004 | 34790 | Cutter wheel pin |

HEAVY DUTY STEEL PIPE CUTTER MAXPOWER

MAXPOWER



| PART# | TYPE | DESCRIPTION |
|--------|---------------------------|-----------------------------|
| MP42A | Cutter | 2A style cuts up to 2" pipe |
| MP4000 | Cutter | 4A style cuts up to 4" pipe |
| MP4003 | Replacement cutter wheels | For 2A heavy duty cutter |
| MP4004 | Replacement cutter wheels | For 4A heavy duty cutter |

ROLL GROOVER, MAXPOWER



- Cast iron body roll groover
- Net weight: 17kg
- Grooves 1-1/4" - 6" schedule 10, and 1-1/4"-3" schedule 40
- Mounts on most standard threaders, including RIDGID and MAXPOWER

| PART# | DESCRIPTION |
|----------|-------------|
| MP91600G | Groover |

POWER THREADER MAXPOWER



- Compact design for easy transportation
- Versatile design
- Motor: 1500W universal type, 110V, Speed: 38 RPM
- Cast aluminum body
- Capacity: 1/2" - 2"
- Automatic die head and oiler with gun
- Two sets of dies and 4 litres of oil included
- T type transporter is optional

| PART# | DESCRIPTION |
|---------|----------------|
| MP50301 | Power threader |

TRADESMEN TOOLS

PIPE CUTTER WHEEL BERKLEY

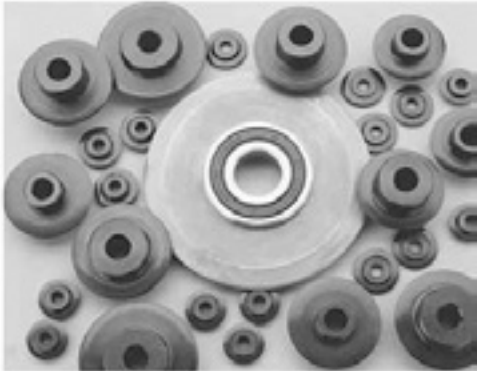

- BERKLEY pipe and tubing cutter wheels are made in the USA using the highest quality tool steel
- Wheels are then heat treated to exacting standards to ensure durability

| PART# | RIDGID X-REF | DESCRIPTION |
|---------|--------------|---|
| BT01000 | 33105 | Heavy duty pipe cutter wheel 2" |
| BT01100 | 33100 | Thin pipe cutter wheel 2" |
| BT01200 | 33110 | Stainless steel pipe cutter wheel 2" |
| BT02000 | 44185 | Pipe cutter wheel 2" |
| BT02100 | 44190 | Pipe cutter wheel 2"stainless steel |
| BT04000 | 33125 | Heavy duty pipe cutter wheel 4" |
| BT06000 | 33145 | Pipe cutter wheel 6" |
| BT01500 | 33160 | Thin tubing cutter wheel for models 10,15,20 |
| BT01210 | 33165 | Heavy duty tubing cutter wheel for models 10,15,20 |
| BT02110 | 33175 | Heavy duty tubing cutter wheel for models 30,40,136,136P |
| BT03400 | 33185 | Thin tubing cutter wheel for models 103,104,105,131,132,205 |
| BT04400 | 03504 | Cutter wheel for std. steel pipe 2" - 4" |
| BT06600 | 03506 | Cutter wheel for std. steel pipe 6" |
| BT06700 | 03524 | Cutter wheel for cast iron pipe 6" - 12" |
| BT08000 | 03508 | Cutter wheel for std. steel pipe 8" - 12" |

THREADED ROD CUTTER



- Designed for cutting mild steel threaded rod
- Deburring work after cut can be ELIMINATED because of unique blades and mechanism
- FASTER, CLEANER and SAFER!
- The answer to the occupational safety ban on using chop saws for deburring threaded rod!
- Approximately 600 cuts per side of double sided blades

| PART# | DESCRIPTION |
|----------|------------------------------------|
| MP991090 | Standard rod cutter with 3/8" dies |
| MP991092 | Replacement 3/8" Dies |

TRADESMEN TOOLS

PACE 1039 MINI-MITE™ SERVICE GROOVER



- Goes from in-place grooving to machine grooving in one motion without the need of spending valuable time looking for tools
- Self-contained
- Can be entirely operated with its own multi-function crank
- Portable & rugged construction with a larger top roller bearing, heavier top slide, and more material in the housing to make for more durability
- All hex drives on the PACE 1039 Mini-Mite™ are 15/16" so one wrench fits everything!
- Chucks in a RIDGID 300, BERKLEY BT3000/BT5020/MAXPOWER 50301

| PART# | DESCRIPTION |
|--------|-------------------------------|
| 991039 | 1¼" – 6" schedule 40 capacity |

HYDROSTATIC TEST PUMPS



- LYNCAR offers general pump equipment line of electrical hydrostatic test pumps
- The leader in this field since 1969
- Housed in a protective metal case and can be used with water or gravity feed
- Shipped with an adjustable relief valve
- Tests fire hose and fire sprinkler systems

| PART# | DESCRIPTION |
|------------|----------------------------------|
| 996334250 | 250 PSI, 1/2 HP, 3 GPM - 60 LBS |
| 996334350 | 350 PSI, 3/4 HP, 3 GPM - 64 LBS |
| 996334550 | 550 PSI, 3/4 HP, 2 GPM - 65 LBS |
| 996334750 | 750 PSI, 1 HP, 2 GPM - 70 LBS |
| 9963341000 | 1000 PSI, 1.5 HP, 2 GPM - 92 LBS |

HAND OPERATED TEST PUMP MAXPOWER

MAXPOWER



- Ideal for pressure testing residential water tanks and solar systems to 200 PSI
- Comes with shut-off valve gauge and connector hose

| PART# | DESCRIPTION |
|--------|-------------------------|
| MP8125 | Hand operated test pump |

SWEDGING TOOL

- For copper tubular
- Swedge copper
- From 3/8" to 3/4" sizes



| PART# | DESCRIPTION |
|-------|--------------|
| 4330 | 3/8" to 3/4" |

COPPER SIZING TOOLS



- Impact type to re-round copper tubing
- For "M" copper tubing

| PART# | DESCRIPTION |
|-------|-------------|
| 4343 | 1/2" |
| 4344 | 3/4" |
| 4345 | 1" |

TRADESMEN TOOLS

TUBE SPRING BENDERS



- For copper, aluminum & soft thin wall tubing
- Length - 10"

PART# DESCRIPTION

| | |
|------|------|
| 5160 | 1/4" |
| 5162 | 3/8" |
| 5164 | 1/2" |
| 5165 | 5/8" |

WRENCH - ADJUSTABLE CHANNELLOCK



- Measurement scales (in. on front mm on reverse) are handy for sizing nuts, pipe and tube diameters
- Easier use in more confined spaces
- Ergonomic handle is wider for more comfortable grip
- Chrome vanadium steel construction with (2NI-1Cr) coating
- Exceeds ASME B 107.8 M, B.S. 6333 and DIN 31117 standard

PART# DESCRIPTION

| | |
|------|-----|
| C804 | 4" |
| C806 | 6" |
| C808 | 8" |
| C810 | 10" |
| C812 | 12" |

COPPER TUBE FLARE PUNCHES



- Soft copper tubing
- Rerounds & flares copper pipe

PART# DESCRIPTION

| | |
|------|------|
| 4367 | 3/4" |
| 4368 | 1" |

COPPER DEBURRING TOOL



- Die cast
- Debur up to 1-1/4" copper or CPVC

PART# DESCRIPTION

| | |
|------|------------|
| 4356 | Metal body |
|------|------------|

TRADESMEN TOOLS

FLARING TOOL - DELUXE



- Deluxe flaring tool with swing release
- Comfort grip handles
- Adjustable gripping pressure
- 3/16" to 5/8" tubing
- Accommodates wide range of tubing

| PART# | DESCRIPTION |
|-------|-------------|
|-------|-------------|

| | |
|------|-----------------------|
| 4361 | Flaring tool - deluxe |
|------|-----------------------|

FLARING TOOL - ECONOMY



- For O.D. sizes: 3/16", 1/4", 5/16", 3/8", 1/2", 5/8"
- Makes smooth flare
- Packed in pouch

| PART# | DESCRIPTION |
|-------|-------------|
|-------|-------------|

| | |
|------|------------------------|
| 4360 | Flaring tool - economy |
|------|------------------------|

DEBURRER HSS



- For quick deburring of edges, tubular and sheet materials
- Replaceable blade and plastic handle

| PART# | DESCRIPTION |
|-------|-------------|
|-------|-------------|

| | |
|-------|-------------------|
| 21655 | Deburrer HSS |
| 21652 | Replacement blade |

EASY BEND KIT FOR SOFT COPPER



- Easily puts a 90° bend on 3/4" tube in less than 10 seconds!
- One hand manual ratchet operation
- Soft copper
- Thin wall hydraulic tubing
- Coated soft copper pipe
- Plastic coated aluminum composite pipe
- **Kit Includes:** 1 ratchet handle, 2 crossbars, 5 bending formers, 1 o.d. / i.d. reamer, 1 tubing cutter 1/8" to 1-1/8" with 1 spare blade, heavy-duty carrying case
- complete package for o.d. 3/8"- 1/2"- 5/8"- 3/4"- 7/8

| PART# | DESCRIPTION |
|-------|-------------|
|-------|-------------|

| | |
|--------|---------------|
| 991555 | Easy bend kit |
|--------|---------------|

HEX KEY TOOL CADDY



- Hex key sets
- Carded for display
- High contractor quality
- Popular sizes for plumbers

| PART# | # OF KEYS | KEY SIZES |
|-------|-----------|-----------|
|-------|-----------|-----------|

| | | |
|------|---|--|
| 3040 | 9 | 5/64", 3/32", 7/64", 1/8", 9/64", 5/32", 3/16" 7/32", 1/4" |
| 3041 | 8 | .050", 1/16", 5/64", 3/32", 7/64", 1/8", 9/64", 5/32" |
| 3042 | 5 | 3/16", 7/32", 1/4", 5/16", 3/8" |
| 3043 | 8 | 3/32", 7/64", 1/8", 9/64", 5/32", 3/16", 7/32", 1/4" |

TRADESMEN TOOLS

PIPE TAPS

- High carbon steel
- Tapered thread taps



| PART# | PIPE SIZE | # OF NPT | TAP DRILL SIZE |
|-------|-----------|----------|----------------|
| 4812 | 1/8" | 27 | 1/8" |
| 4813 | 1/4" | 18 | 7/16" |
| 4814 | 3/8" | 18 | 37/64" |
| 4815 | 1/2" | 14 | 45/64" |
| 4816 | 3/4" | 14 | 59/64" |
| 4817 | 1" | 11-1/2 | 1-5/32" |
| 4818 | 1-1/4" | 11-1/2 | 1-1/2" |
| 4819 | 1-1/2" | 11-1/2 | 1-47/64" |
| 4820 | 2" | 11-1/2 | 2-7/32" |

DRILL SET - 29 PIECE



- Sizes 1/16" to 1/2" by 64ths
- Polished flutes
- High speed steel industrial quality
- Compact steel case
- Guaranteed quality
- Drill Compartment which serves as handy drill gauges

| PART# | DESCRIPTION |
|-------|--------------------|
| 4664 | Drill set 29 piece |

DRILL SET
13 PIECE



- Sizes 1/16" to 1/4" by 64ths
- Polished flutes
- High speed steel for wood, plastic and soft or thin gauge metal
- Plastic case
- Blister carded for peg board

| PART# | DESCRIPTION |
|-------|--------------------|
| 4663 | Drill set 13 piece |

CARBIDE HOLE
SAWS

- Cuts ceramic tile & stainless steel
- Complete with d-drive arbor & carbide drill



| PART# | DESCRIPTION |
|-------|--------------------------|
| 3912 | 1-1/4" |
| 3913 | 1-3/8" |
| 3915 | 1-3/4" |
| 3916 | Arbor with carbide drill |

CARBIDE BI-METAL
BLADES

- 6" or 9" blades x 3/4" width
- Fits most reciprocating saws
- Flexible alloy steel
- Diamond hard tungsten carbide grit

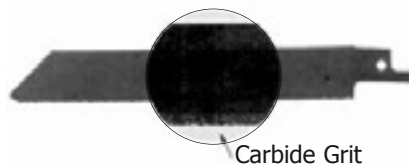

| PART# | DESCRIPTION |
|-------|-------------|
| 3835 | 6" blade |
| 3845 | 9" blade |

TRADESMEN TOOLS

ON CENTRE TOOL



- Accurately locates position of holes to be drilled into pipe
- Excellent for field or shop use
- The housing is aluminum
- The mineral spirit leveling vials are inset, protected by the housing and visible from 2 sides
- They are made from tough acrylic plastic and can be replaced if damaged

| PART# | DESCRIPTION |
|-------|----------------|
| 990N | On centre tool |

SPOT RIGHT LEVEL



- Both a torpedo level and a gunner nipple in one handy tool
- Also has 1/2", 3/4", and 1" threaded ends for multiple use

| PART# | DESCRIPTION |
|-------|------------------|
| 99SR | Spot right level |

PLUMB BOBS



- Nickel plated
- True hanging

| PART# | DESCRIPTION |
|-------|--------------|
| 4450 | 3-3/8" x 5oz |
| 4451 | 3-3/4" x 8oz |

TORPEDO LEVEL



- Magnet and grooved
- Coloured liquid in vials
- 9" length
- Magnet for iron pipe
- Black plastic

| PART# | DESCRIPTION |
|-------|-------------------|
| 4472 | Level, plastic 9" |

TAPE MEASURE - K74 DURA-COAT



- Power return
- Belt Clip
- Yellow Steel & Tape
- Nylon Coated Blade
- Metric & Imperial Rule

| PART# | DESCRIPTION |
|-------|-------------|
| 3948 | 3/4" x 16' |
| 3949 | 1" x 25' |

MAGNETIC TAPE MEASURE



- Large magnetic end hook
- Nylon coated blade for maximum durability
- Impact absorbing rubber jacket protects case
- Private label opportunity on orders over 500pcs

| PART# | DESCRIPTION |
|--------|----------------------------|
| 3947LC | 1" x 25' metric & imperial |

TRADESMEN TOOLS

CHALK PLUMB LINE



- Will mark on any surface (wood, brick, stone, & metal)
- Die cast aluminum case
- Durable grey enamel finish
- Slide action lock and hook ring provides true plumb bob action
- Lock releases automatically on rewind
- Opens for easy filling of powdered chalk
- Nylon line on pop - in reel is easily replaced

| PART# | DESCRIPTION |
|-------|--------------------|
| 5193 | Chalk & Plumb Line |

CHALK REFILLS



- For self chalking reels
- High visibility
- Long lasting

| PART# | DESCRIPTION |
|-------|-----------------|
| 5196 | Red 12 x 8 oz. |
| 5195 | Blue 12 x 8 oz. |

FLASHLIGHT RAYOVAC



- Flashlights by RAYOVAC, water resistant construction polypropylene shock proof, and chemical / grease proof.
- Superior light performance.
- All flashlights take size "D" batteries.

| PART# | DESCRIPTION |
|-------|----------------|
| 362 | Regular 2 cell |
| 363 | Long 3 cell |
| 365 | Magnet 2 cell |

FLASHLIGHT INDUSTRIAL



- Industrial grade flashlights, good quality , tough and built to last.

| PART# | DESCRIPTION |
|-------|----------------|
| 367 | Regular 2 cell |
| 369 | Magnet 2 cell |

LANTERNS



- Two types of Lantern flashlights available, standard or on a swivel base
- 6 volt batteries

| PART# | DESCRIPTION |
|-------|-------------|
| 325 | Swivel |
| 326 | Standard |

FLASHLIGHT BULBS



- Replacement bulbs for LynCar and other standard flashlights

| PART# | DESCRIPTION |
|-------|-----------------|
| 383 | For 2 "D" cells |
| 384 | For 3 "D" cells |

TRADESMEN TOOLS

TROUBLE LIGHTS



- LYNCAR'S trouble lights are professional quality with metal bulb guards.
- All models have a 13A electrical rating and 16/3 core rated cords.
- **Part# 8072 & part#8073** have "ARCTIC CORDS" a premium outdoor cord good for up to -58 degrees !
- cUL listed

| PART# | LENGTH | CORD TYPE |
|-------------|--------|-----------|
| 8072 | 25 ft | Arctic |
| 8073 | 50 ft | Arctic |
| 8165 | 25 ft | Standard |
| 8166 | 50 ft | Standard |

VINYL OUTDOOR EXTENSION CORDS



- Three conductor
- Lighted ends
- Meets OSHA requirements for outdoor use
- Vinyl jacket resists moisture, abrasion and prolonged exposure to sunlight
- 12/3 SJTW, 15A rating
- cUL listed

| PART# | DESCRIPTION |
|-------------|-------------|
| 8167 | 50' |
| 8168 | 100' |

E/Z WIND CORD ORGANIZER



- Holds up to 100' of electrical extension cord
- Holds 2 different cords
- Comfort grips

| PART# | DESCRIPTION |
|-------------|----------------|
| 4862 | Cord organizer |

TRADESMEN TOOLS

CAULKING GUN - DROP IN HALF BARREL



- Drop in half barrel type caulk gun
- Steel body construction
- Smooth rod with hook end for easy dispensing
- Thumbs release and spring release
- Fits all standard size tubes

CAULKING GUN - SKELETON TYPE



- Skeleton type caulk gun
- Steel construction
- Hex rod
- Built in ladder hook and catch plate

| PART# | DESCRIPTION |
|-------|---------------------|
| 5100 | Drop in half barrel |

| PART# | DESCRIPTION |
|-------|---------------|
| 5105 | Skeleton type |

SCREEDING PADS SET



- Fills cracks and removes extra filler
- Fills cracks between the tiles
- 4 pc set for up to 18 shapes
- Carded for display

| PART# | DESCRIPTION |
|-------|----------------|
| 5050 | Screeding pads |

SILICONE SCRAPER



- Silicone scraper with stainless steel blade
- Multi function design
- Works in forward or backward position
- Cleaning blade in handle
- Carded for display

| PART# | DESCRIPTION |
|-------|------------------|
| 5045 | Silicone scraper |

HAND & CUTTING TOOLS

HACKSAW



- Adjusts to 4 lengths, plated frame
- DIY quality

| PART# | DESCRIPTION |
|-------|--------------------|
| 4254 | Adjusts 10" to 12" |

SUPER HACKSAW



- Comfort front end grip
- Tension wheel for tighter blade
- Stores extra blades
- Cuts sideways
- Cuts flush to surface
- 4" Depth
- Supplied with 12" blades

| PART# | DESCRIPTION |
|-------|---------------|
| 4267 | Super hacksaw |

HACKSAW LENOX



- Lever tensions the 12" (300mm) hacksaw blade to 30,000 psi (21 kg. mm2), about twice that of ordinary frames
- Mount blade at 45° for flush cutting jobs
- Use frame as jab saw. Set screw holds blade in position
- Use as a compass saw with No.20585-156R reciprocating blade
- Store spare blades inside tubular back

| PART# | DESCRIPTION |
|-------|-------------|
| L4012 | Hacksaw |

HACKSAW BLADES LENOX



- Electron beam weld
- High speed steel edge
- Tuff tooth
- Flexible spring steel back

| PART# | LENGTH | TPI |
|-------|--------|-----|
| L018 | 10" | 18 |
| L024 | 10" | 24 |
| L032 | 10" | 32 |
| L214 | 12" | 14 |
| L218 | 12" | 18 |
| L224 | 12" | 24 |
| L232 | 12" | 32 |

TRADESMEN'S TOOLS

HAND & CUTTING TOOLS

JOURNEYMAN PLASTIC PIPE SAW



- Cuts PVC, ABS, fiber pipe, wood and drywall
- Unbreakable aluminum die cast handle
- Large, comfortable grip
- Flame hardened blade
- Replacement blade changes in seconds
- Ten teeth per inch

| PART# | DESCRIPTION | DESCRIPTION |
|--------|-------------------------|------------------------------|
| 4331 | MITY MITE 13" saw | Complete saw w/ metal handle |
| 4333 | JOURNEY MAN 18" saw | Complete saw w/ metal handle |
| 4333H | Handle only for PVC saw | Aluminum die cast handle |
| 4333UH | Handle only for PVC saw | Unbreakable plastic handle |
| 4331B | Blade only for PVC saw | 13" Blade |
| 4333B | Blade only for PVC saw | 18" Blade |

PVC/ABS SAW LENOX



- Wide, rigid carbon steel blade with hardened teeth will breeze through any diameter plastic pipe, wood and nail-embedded wood
- Its heavy-duty, lightweight aluminum handle features a comfortable hand grip and a large opening for maximum finger clearance, allowing room for work gloves

| PART# | TYPE | SIZE |
|---------|--------------|-----------------------------|
| LHSF120 | Complete saw | 12" |
| LHSF180 | Complete saw | 18" |
| LHSB12 | Blade only | 12" |
| LHSB18 | Blade only | 18" |
| L-FCBA | Blade only | Blade adaptor flush cutting |

PIPE SHOOTER - PVC INSIDE CUTTER



- Internal PVC cutter
- Fits all electric drills, Pipe Shooter is the fast and easy way to make cuts for closet flange, tub waste overflow and shower drains
- The blade is hardened steel for tough, long lasting cutting of pipes 1 1/2" and larger
- Saves installation time

Cuts Fast! Easy to Use! Cutoff:

- PVC / ABS Closet Flange
- Tub Waste and Overflow
- Shower Drains
- Many Hard to Reach Applications
- Also Cuts Wood for Sink Rim Lugs



| PART# | DESCRIPTION |
|---------|--------------------------|
| 99PS100 | 4-1/2" - length shaft |
| 99PS110 | 7-1/2" - length shaft |
| 99PS102 | Replacement cutter wheel |

TRADESMEN TOOLS

TINY TIM HACKSAW



- Cuts wood, plaster, steel, brass, etc.
- Vinyl grip handle
- 1/4" x 6" x 32T
- Tube of 10 replacement blades (**part# 4292**)

| PART# | DESCRIPTION |
|-------------|----------------------------|
| 4290 | Hacksaw with blade |
| 4292 | 10 pack replacement blades |

CLOSE QUARTER® SAW LENOX



- Close cutter saw to cut in tight areas

| PART# | DESCRIPTION |
|-------------|------------------|
| L908 | Hacksaw w/ blade |
| L906 | Blades 10Pk |

TRI-FOLD SAW LENOX



- Fits in your pocket
- Three locking positions
- For wood and /or drywall
- Uses standard blades
- Comfortable hand grip

| PART# | DESCRIPTION |
|----------------|------------------|
| L3618 | For metal |
| L3636 | Wood, drywall |
| L618636 | With both blades |

PVC CABLE SAW

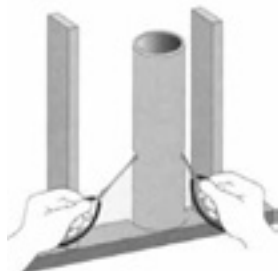

- 24" stainless steel cable
- Great for tight spots, need only 1/4" clearance
- Easily stored
- 30" overall

| PART# | DESCRIPTION |
|-------------|---------------|
| 4336 | PVC cable saw |

SAW BLADES - BI-METAL RECIPROCATING - LENOX

LENOX 414R BLADE



- Heavy gauge metal 1/4"-1/2" / 6-13mm, hard rubber, fiber & angle iron
- TPI = 14T

LENOX 418R BLADE



- Heavy gauge metal 1/8"-1/4" / 3.2-6mm, conduit & tubing, opening wood crates, removing wood siding or shingles
- TPI = 18T

| PART# | # PER PACK | SIZE |
|--------|------------|----------------|
| L414R | 5 | 4 x 3/4 x .035 |
| L414RQ | 25 BULK | 4 x 3/4 x .035 |

| PART# | # PER PACK | SIZE |
|--------|------------|----------------|
| L418R | 5 | 4 x 3/4 x .035 |
| L418RQ | 25 BULK | 4 x 3/4 x .035 |

LENOX 610R BLADE



- Wood, compositions, plastic, cast aluminum & non-ferrous metals
- TPI=10T

| PART# | # PER PACK | SIZE |
|--------|------------|----------------|
| L610R | 5 | 6 x 3/4 x .035 |
| L610RQ | 25 BULK | 6 x 3/4 x .035 |

LENOX 614R BLADE



- Heavy gauge metal 1/4"-1/2" / 6-13mm, hard rubber, fiber & angle iron
- TPI=14T

| PART# | # PER PACK | SIZE |
|--------|------------|----------------|
| L614R | 5 | 6 x 3/4 x .035 |
| L614RG | 5 GOLD | 6 x 3/4 x .035 |
| L614RQ | 25 BULK | 6 x 3/4 x .035 |

LENOX 618R BLADE



- Heavy gauge metal 1/8"-1/4" / 3.2-6mm, conduit & tubing, wood siding or shingles
- TPI=18T

| PART# | # PER PACK | SIZE |
|--------|------------|----------------|
| L618R | 5 | 6 x 3/4 x .035 |
| L618RG | 5 GOLD | 6 x 3/4 x .035 |
| L618RQ | 25 BULK | 6 x 3/4 x .035 |

LENOX 624R BLADE



- Finer teeth for faster cutting of metal to 1/8", galvanized pipe
- TPI=24T

| PART# | # PER PACK | SIZE |
|--------|------------|----------------|
| L624R | 5 | 6 x 3/4 x .035 |
| L624RG | 5 GOLD | 6 x 3/4 x .035 |
| L624RQ | 25 BULK | 6 x 3/4 x .035 |

TRADESMEN TOOLS

LENOX 636RP BLADE



- For plaster, plaster board and lath
- Bi-directional cutting
- TPI= 6T

| PART# | # PER PACK | SIZE |
|---------------|------------|-----------------|
| L636RP | 5 | 6 x 3/4 x .050" |
| L636RQ | 25 BULK | 6 x 3/4 x .050" |

LENOX 650R BLADE



- Heavy duty. Extended life when cutting pipe, structural steel, stainless steel: 3/16"-3/4"/ 5-20mm. Fire and rescue
- TPI=10/14T

| PART# | # PER PACK | SIZE |
|--------------|------------|-----------------|
| L650R | 2 | 6 x 3/4 x .050" |

LENOX 656R BLADE



- Rough work in wood, fast cutting, used in remodeling and demolition work
- TPI=6T

| PART# | # PER PACK | SIZE |
|---------------|------------|-----------------|
| L656R | 5 | 6 x 3/4 x .050" |
| L656RG | 5 GOLD | 6 x 3/4 x .050" |
| L656RQ | 25 BULK | 6 x 3/4 x .050" |

LENOX 676RC BLADE



- Wood contours
- TPI=6T

| PART# | # PER PACK | SIZE |
|---------------|------------|-----------------|
| L676RC | 5 | 6 x 7/16 x .050 |

LENOX 810R BLADE

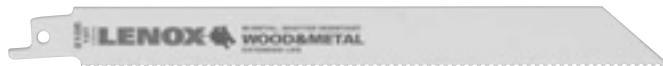

- Wood, compositions, plastic, cast aluminum, light non-ferrous metals & stainless steel
- TPI=10T

| PART# | # PER PACK | SIZE |
|---------------|------------|-----------------|
| L810R | 5 | 8 x 3/4 x .050" |
| L810RG | 5 GOLD | 8 x 3/4 x .050" |
| L810RQ | 25 BULK | 8 x 3/4 x .050" |

LENOX 818R BLADE

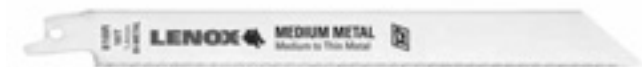

- Heavy gauge metal 1/8"-1/4" / 3.2-6mm, conduit & tubing, opening wood crates, removing wood siding or shingles
- TPI=18T

| PART# | # PER PACK | SIZE |
|---------------|------------|-----------------|
| L818R | 5 | 8 x 3/4 x .035" |
| L818RG | 5 GOLD | 8 x 3/4 x .035" |
| L818RQ | 25 BULK | 8 x 3/4 x .035" |

TRADESMEN TOOLS

LENOX 850R BLADE



- Heavy duty. Extended life when cutting pipe, structural steel, stainless steel: 3/16"-3/4"/ 5- 20mm. Fire and rescue
- TPI= 10/14T

| PART# | # PER PACK | SIZE |
|--------|------------|-----------------|
| L850R | 5 | 8 x 3/4 x .050" |
| L850RQ | 25 BULK | 8 x 3/4 x .050" |

LENOX 956R BLADE



- Rough work in wood, fast cutting, used in remodeling and demolition work.
- TPI= 6T

| PART# | # PER PACK | SIZE |
|--------|------------|----------------|
| L956R | 5 | 9 x 3/4 x .050 |
| L956RG | 5 GOLD | 9 x 3/4 x .050 |

LENOX 960R BLADE



- Demolition work in wood and metal. Fire and rescue.
- TPI= 10T

| PART# | # PER PACK | SIZE |
|--------|------------|----------------|
| L960 | 2 | 9 x 7/8 x .062 |
| L960RQ | 25 | 9 x 7/8 x .062 |

LENOX 966R BLADE



- Demolition work in nail-embedded wood.
- TPI= 6T

| PART# | # PER PACK | SIZE |
|-------|------------|----------------|
| L966R | 2 | 9 x 7/8 x .062 |

LENOX 110R BLADE



- All woods, plastic, cast aluminum & light non-ferrous metals, stainless steel.
- TPI= 10/14T

| PART# | # PER PACK | SIZE |
|--------|------------|-----------------|
| L110R | 5 | 12 x 3/4 x .050 |
| L110RQ | 25 BULK | 12 x 3/4 x .050 |

LENOX 118R BLADE



- Heavy gauge metal 1/4"-1/2" /6-13mm, hard rubber, fiber & angle iron
- TPI= 18T

| PART# | # PER PACK | SIZE |
|-------|------------|-----------------|
| L118R | 5 | 12 x 3/4 x .035 |

LENOX 156R BLADE



- Rough work in wood, fast cutting, used in remodeling and demolition work.
- TPI= 6T

| PART# | # PER PACK | SIZE |
|--------|------------|-----------------|
| L156R | 5 | 12 x 3/4 x .050 |
| L156RG | 5 GOLD | 12 x 3/4 x .050 |
| L156RQ | 25 BULK | 12 x 3/4 x .050 |

ABRASIVE RECIPROCATING SAW BLADE



- 3/4" Width
- Fits most reciprocating saws
- Flexible alloy steel
- Diamond hard tungsten carbide grit makes this blade last up to 20 times longer than conventional blades

| PART# | SIZE |
|--------|------|
| L600RG | 6" |
| L800RG | 8" |
| L100RG | 10" |

TRADESMEN TOOLS

JIG SAW BLADE LENOX

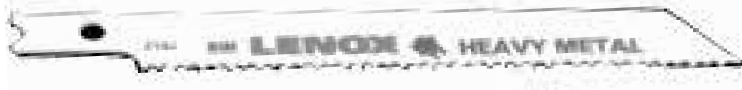

- 2 per pack

| PART# | SIZE | TPI | CUTS THESE MATERIALS |
|--------------|--------------------|-----|--|
| L314J | 3 x 3/8 x .037 | 14 | Steels: 3/32" to 1/4" non-ferrous metal: 3/32" to 3/8" |
| L318J | 3 x 3/8 x .037 | 18 | Stainless steel, structural steel: 1/16" to 3/16" |
| L480J | 4-1/2 x 3/8 x .050 | 10 | Wood, nail-embedded wood: 1/4" to 2" thick. all steels: 1/8" to 1/2" soft metals: 1/8" to 1" |
| L406S | 4-1/2 x 3/8 x .050 | 6 | Fast, rough cutting in wood and composition material: 3/8" to 2" thick. chromium jig saw blade |

SAW BLADES - BI-METAL PORTABLE BAND SAW



| PART# | SIZE | TPI | CUTS THESE MATERIALS |
|---------------|---------------------|-------|--|
| L80146 | 53-3/4 x 1/2 x .025 | 10/14 | 1/4" & larger, metals, including stainless steel |
| L80147 | 53-3/4 x 1/2 x .025 | 14/18 | 1/8"- 5/16," metals, including stainless steel |
| L80112 | 44-7/8 x 1/2 x .023 | 14/18 | 1/8"- 5/16," most metals |
| L80142 | 44-7/8 x 1/2 x .025 | 14/18 | 1/8"- 5/16," metals, including stainless steel |
| L80144 | 44-7/8 x 1/2 x .025 | 10/14 | 1/4" & larger, metals, including stainless steel |

VARI-BIT® STEP DRILL BITS



- High speed steel construction and steam oxide coating
- Two cutting flutes allow for clean burr-free holes. These bits will cut through materials faster than standard bits, including stainless steel up to 1/8" (3.2mm) thick

| PART# | SIZE |
|--------------|----------------|
| LVB1 | 1/8" to 1/2" |
| LVB2 | 1/2" to 1" |
| LVB8 | 3/16" to 7/8" |
| LVB12 | 7/8" to 1-3/8" |

WOOD BORING

WOOD HOLE CUTTER ONE TOOTH

LENOX



- The LENOX® Advantage™ Patented Design 3 Times faster than regular hole saws
- Safer/less torque than self feed bits, therefore...
- Causes less fatigue on the user
- Can be run on lower power machines
- Can also run at higher speeds (1200 rpm)
- Easy plug ejection
- Cuts wet, frozen, pressure treated, and hard wood without binding (unlike self-feed bits)
- Resharpenable, cuts more than 300 holes before resharpening is even needed
- Deep enough to go through 2 x 4 and 3/4" plywood.

| PART# | SIZE | APPLICATION |
|-------|---------|--------------------------------------|
| 6920 | 2-1/8" | 1-1/2" pipe, lock installation |
| 6921 | 2-1/4" | 1-1/2" pipe & 45°/90° bend couplings |
| 6922 | 2-9/16" | 2" pipe |
| 6923 | 2-3/4" | 2" pipe & 45°/90° bend couplings |
| 6924 | 3-3/8" | 3" duct pipe & bendable duct pipe |
| 6925 | 3-5/8" | 3" pipe |
| 6926 | 4" | 3" pipe & coupling, dryer vent |
| 6927 | 4-5/16" | 4" duct pipe & bendable duct pipe |
| 6928 | 4-5/8" | 4" pipe |
| 6929 | 5" | 4" pipe & coupling |
| 6930 | | 3/8" Stubby Spade Bit |

LEADER BITS

LENOX



LENOX® Leader® bits with their precision ground teeth and outside diameter threads are designed for automatic feeding. Forged body design and strong construction allow free-flow chip removal.

Leader bits cut very deeply, going through a 4x4 wooden beam without needing an extension and can be resharpened with a file.

| PART# | SIZE | PIPE & RIGID CONDUIT | TUBING |
|-------|---------|----------------------|--------|
| LL100 | 1" | 1/2" | 7/8" |
| LL112 | 1-1/8" | 1/2" | 1" |
| LL125 | 1-1/4" | 3/4" | 1-1/8" |
| LL137 | 1-3/8" | 1 | 1-1/4" |
| LL150 | 1-1/2" | | 1-3/8" |
| LL175 | 1-3/4" | 1-1/4" | 1-1/2" |
| LL200 | 2 | 1-1/2" | 1-7/8" |
| LL212 | 2-1/8" | | 2" |
| LL256 | 2-9/16" | 2 | 2-1/2" |
| L12LS | | Lead Screw 5-PK | |

TRADESMEN TOOLS

HOLE SAW - LENOX



| PART# | SIZE | PART# | SIZE | PART# | SIZE | PART# | SIZE |
|-------|---------|-------|----------|-------|---------|-------|--------|
| L9L | 9/16" | L21L | 1-5/16" | L36L | 2-1/4" | L56L | 3-1/2" |
| L10L | 5/8" | L22L | 1-3/8" | L37L | 2-5/16" | L58L | 3-5/8" |
| L11L | 11/16" | L23L | 1-7/16" | L38L | 2-3/8" | L60L | 3-3/4" |
| L12L | 3/4" | L24L | 1-1/2" | L40L | 2-1/2" | L62L | 3-7/8" |
| L13L | 13/16" | L26L | 1-5/8" | L41L | 2-9/16" | L64L | 4" |
| L14L | 7/8" | L27L | 1-11/16" | L42L | 2-5/8" | L66L | 4-1/8" |
| L15L | 15/16" | L28L | 1-3/4" | L44L | 2-3/4" | L68L | 4-1/4" |
| L16L | 1" | L29L | 1-13/16" | L46L | 2-7/8" | L70L | 4-3/8" |
| L17L | 1-1/16" | L30L | 1-7/8" | L48L | 3" | L72L | 4-1/2" |
| L18L | 1-1/8" | L32L | 2" | L50L | 3-1/8" | L76L | 4-3/4" |
| L19L | 1-3/16" | L33L | 2-1/16" | L52L | 3-1/4" | L80L | 5" |
| L20L | 1-1/4" | L34L | 2-1/8" | L54L | 3-3/8" | L88L | 5-1/2" |
| | | | | | | L96L | 6" |

**CARBIDE HOLE SAW
LENOX**



| PART# | SIZE | TYPE |
|-------|--------|-------------|
| L12CT | 3/4" | Carbide tip |
| L14CT | 7/8" | Carbide tip |
| L16CT | 1" | Carbide tip |
| L20CT | 1-1/4" | Carbide tip |
| L22CT | 1-3/8" | Carbide tip |
| L24CT | 1-1/2" | Carbide tip |
| L28CT | 1-3/4" | Carbide tip |
| L48CT | 3" | Carbide tip |
| L58CT | 3-5/8" | Carbide tip |
| L76CT | 4-3/4" | Carbide tip |

ARBORS FROM LENOX

LENOX 011L ARBOR



- Shank= HEX
- Chuck=1/2" & Larger

PART# FITS HOLE SAW

L011L L9L-L19L

LENOX 011SL ARBOR



- Shank= SDS
- Chuck= -

PART# FITS HOLE SAW

L011SL L9L-L19L

LENOX 022L ARBOR



- Shank= HEX
- Chuck= 1/2" & Larger

PART# FITS HOLE SAW

L022L L20L-L96L

LENOX 022SL ARBOR



- Shank=SDS
- Chuck= -

PART# FITS HOLE SAW

L022SL L20L-L96L

LENOX 033L ARBOR



- Shank=SOLID / HEX
- Chuck= 1/2" & Larger

PART# FITS HOLE SAW

L033L L20L-L96L

LENOX 044L ARBOR



- Shank=3 SIDED
- Chuck= 1/4" & Larger

PART# FITS HOLE SAW

L044L L9L-L19L

LENOX ARBORS & TOOLS

LENOX 055L ARBOR



- Shank= HEX
- Chuck= 3/8" & Larger

| PART# | DESCRIPTION |
|-------|-------------|
| L055L | L9L-L19L |

LENOX 066L ARBOR



- Shank= HEX
- Chuck= 3/8" & Larger

| PART# | DESCRIPTION |
|-------|-------------|
| L066L | L20L-L96L |

LENOX 077L ARBOR



- Shank= HEX
- Chuck= 3/8" & Larger

| PART# | DESCRIPTION |
|-------|-------------|
| L077L | L24L-L96L |

**ARBOR PILOT DRILLS
LENOX**



| PART# | # IN PACK | DESCRIPTION |
|--------|---------------------|--|
| L4321 | Pilot drill 10 pack | L011L, L022L, L044L |
| LB4321 | Pilot drill 25 pack | L011L, L022L, L044L |
| L56PD | Pilot drill 1 pack | L011SL, L022SL, L033L, L055L, L066L, L077L |

**HOLE SAW (BI-METAL)
PLUMBER KIT - LENOX**



- PLUMBER KIT, small 6pcs
Contains holesaws:
- 3/4" to 2-1/4"
- PLUMBER KIT, Large, 12pcs
Contains holesaws:
- 3/4" to 4-1/2"
- 12 hole saws

| PART# | DESCRIPTION |
|--------|------------------------------|
| L600P | Plumbers kit - small (6 pcs) |
| L1200P | Plumbers kit, large (12 pcs) |

**HOLE SAW (BI-METAL)
BIG DADDY KIT - LENOX**



- BIG DADDY KIT
- Contains holesaws:
3/4", 7/8", 1", 1 1/8", 1 3/8", 1 1/2", 1 3/4", 2", 2 1/8", 2 1/4", 2 1/2", 2 11/16", 3", 3 1/4", 3 3/8", 3 5/8", 3 3/4", 4 1/8", 4 1/2", 4 3/4" (19, 22, 25, 29, 35, 38, 44, 51, 54, 57, 64, 68, 76, 83, 86, 92, 95, 105, 114, 121mm). Arbors: 1L, 2L, 5L.
 - Two 4321 and one 56PD pilot drills.

| PART# | DESCRIPTION |
|--------|---------------|
| L2000G | Big daddy kit |

TRADESMEN TOOLS

COB PIPE FREEZING SYSTEM



The COB pipe freezing system by LYNCAR, is a jacket system using CO². Available from 1/2" to 8" jackets. Tanks sold separately.

You can rent CO² tanks from your local gas supplier dealer. By wrapping the jacket around the pipe of stagnant water, then applying CO², this will form dry ice, in turn freezing the water causing an ice plug

- All kits are supplied with carrying case, jackets, hoses, connections for tank, instructions, mallet & gloves and timing pad. You may increase the size of your kit anytime, we offer all items separately, please call LYNCAR for details

| PART# | DESCRIPTION |
|--------|--|
| QF1500 | Freeze kit 3/8" to 1-1/2" pipe |
| QF2000 | Freeze kit 3/4" to 1-1/2" pipe |
| QF2200 | Freeze kit 3/8" to 1-1/2" pipe (double freeze) |
| QF3000 | Freeze kit 3/8" to 3" pipe |
| QF4000 | Freeze kit 3/8" to 4" pipe |
| QFAL20 | Alum. tank w/ tube 20lb |

ROFROST CO2 PIPE FREEZING UNIT



- Simple, quick, safe freezing using carbon dioxide
- No CFC's
- Copper tubes 10 - 60 mm OD 1/2" - 2 1/8" OD steel pipes 1/8" - 2" OD
- Economic and environmentally friendly option for the plumbing and heating engineer when servicing, repairing or extending pipe systems, without the need for time consuming draining down
- Good for customer relations – no prolonged discussion about when to do the job, and no inconvenience is caused to third parties not involved by having to have their water turned off
- Ideal when replacing faulty parts, e.g. thermostatic regulator valves etc
- Eliminates the risk of air-locks heating systems.

| PART# | DESCRIPTION |
|--------|--------------------------------|
| R65030 | ROFROST CO2 Pipe Freezing Unit |

TRI STAND MAXPOWER



- Comparable to:
- RIDGID™ 460
 - BERKLEY™ BT335, BT333
 - Ships fully assembled
 - Chain vise stand tri-stand vise has folding lower tray for ease of transporting, while providing additional workspace to hold tool, or oil cans within convenient reach
 - Vise base has integral pipe rest and pipe bending slots and hardened replaceable jaws
 - Parts interchangeable with competitive style units

| PART# | DESCRIPTION |
|-------|-------------|
| MP200 | Tri Stand |

| | | | | | | | | | | | | | |
|--------|-----|-------|-----|------|-----|-------|-----|-------|-----|-------|-----|--------|------|
| 13866 | 3.5 | 1449 | 2.5 | 1428 | 3.1 | 1774 | 2.2 | 2001 | 3.1 | 20158 | 2.5 | 205425 | 2.42 |
| 13888 | 3.5 | 1449C | 2.5 | 1425 | 3.1 | 1774A | 2.2 | 2007 | 3.1 | 20157 | 2.5 | 205427 | 2.42 |
| 13890 | 3.5 | 1450 | 2.5 | 1424 | 3.1 | 1774 | 2.2 | 2007A | 3.1 | 20159 | 2.5 | 205430 | 2.42 |
| 13891 | 3.5 | 1450M | 2.5 | 1422 | 3.1 | 1774A | 2.2 | 2007Z | 3.1 | 20160 | 2.5 | 205432 | 2.42 |
| 13897 | 3.5 | 1451 | 2.5 | 1418 | 3.1 | 1776 | 2.2 | 2007A | 3.1 | 20161 | 2.5 | 205433 | 2.42 |
| 13895 | 3.5 | 1457 | 2.5 | 1424 | 3.1 | 1776A | 2.2 | 2007B | 3.1 | 20162 | 2.5 | 205434 | 2.42 |
| 13896 | 3.5 | 1458 | 2.5 | 1422 | 3.1 | 1777 | 2.2 | 2007C | 3.1 | 20163 | 2.5 | 205435 | 2.42 |
| 13897 | 3.7 | 1459 | 2.5 | 1421 | 3.1 | 1777A | 2.2 | 2007D | 3.1 | 20164 | 2.5 | 205436 | 2.42 |
| 13900 | 3.7 | 1460 | 2.5 | 1427 | 3.1 | 1777A | 2.2 | 2007E | 3.1 | 20165 | 2.5 | 205437 | 2.42 |
| 13902 | 3.7 | 1466 | 2.5 | 1428 | 3.1 | 1782 | 2.2 | 2007F | 3.1 | 20166 | 2.5 | 205438 | 2.42 |
| 13910 | 3.5 | 1467 | 2.5 | 1429 | 3.1 | 1782S | 2.2 | 2007G | 3.1 | 20167 | 2.5 | 205439 | 2.42 |
| 13912 | 3.4 | 1468 | 2.5 | 1430 | 3.1 | 1783 | 2.2 | 2007H | 3.1 | 20168 | 2.5 | 205440 | 2.42 |
| 13913 | 3.4 | 1469 | 2.5 | 1431 | 3.1 | 1783 | 2.2 | 2007I | 3.1 | 20169 | 2.5 | 205441 | 2.42 |
| 13915 | 3.4 | 149 | 2.2 | 1432 | 3.1 | 1801 | 3.2 | 2007J | 3.1 | 20170 | 2.5 | 205442 | 2.42 |
| 13917 | 3.4 | 1500 | 2.5 | 1433 | 3.1 | 1804 | 3.2 | 2007K | 3.1 | 20171 | 2.5 | 205443 | 2.42 |
| 13918 | 3.4 | 1501 | 2.5 | 1435 | 3.1 | 1804 | 3.2 | 2007L | 3.1 | 20172 | 2.5 | 205444 | 2.42 |
| 13919 | 3.7 | 1501A | 2.5 | 1435 | 3.1 | 1804 | 3.2 | 2007M | 3.1 | 20173 | 2.5 | 205445 | 2.42 |
| 13919M | 3.7 | 1500 | 2.5 | 1437 | 3.1 | 1804 | 3.2 | 2007N | 3.1 | 20174 | 2.5 | 205446 | 2.42 |
| 13922 | 3.4 | 1505 | 2.5 | 1440 | 3.1 | 1805 | 3.2 | 2007O | 3.1 | 20175 | 2.5 | 205447 | 2.42 |
| 13923 | 3.4 | 1510 | 2.5 | 1441 | 3.1 | 1807 | 3.2 | 2007P | 3.1 | 20176 | 2.5 | 205448 | 2.42 |
| 13924 | 3.4 | 1511 | 2.5 | 1443 | 3.1 | 1807 | 3.2 | 2007Q | 3.1 | 20177 | 2.5 | 205449 | 2.42 |
| 13925 | 3.7 | 1512 | 2.5 | 1443 | 3.1 | 1807 | 3.2 | 2007R | 3.1 | 20178 | 2.5 | 205450 | 2.42 |
| 13926 | 3.7 | 1512S | 2.5 | 1443 | 3.1 | 1807 | 3.2 | 2007S | 3.1 | 20179 | 2.5 | 205451 | 2.42 |
| 13927 | 3.7 | 1514 | 2.5 | 1447 | 3.1 | 1808 | 3.2 | 2007T | 3.1 | 20180 | 2.5 | 205452 | 2.42 |
| 13928 | 3.7 | 1514 | 2.5 | 1447 | 3.1 | 1808 | 3.2 | 2007U | 3.1 | 20181 | 2.5 | 205453 | 2.42 |
| 13929 | 3.7 | 1515 | 2.5 | 1447 | 3.1 | 1807 | 3.2 | 2007V | 3.1 | 20182 | 2.5 | 205454 | 2.42 |
| 13930 | 3.7 | 1520 | 2.5 | 1448 | 3.1 | 1808 | 3.2 | 2007W | 3.1 | 20183 | 2.5 | 205455 | 2.42 |
| 13940 | 3.4 | 1521 | 2.5 | 1449 | 3.1 | 1808 | 3.2 | 2007X | 3.1 | 20184 | 2.5 | 205456 | 2.42 |
| 13941 | 3.4 | 1521B | 2.5 | 1449 | 3.1 | 1808 | 3.2 | 2007Y | 3.1 | 20185 | 2.5 | 205457 | 2.42 |
| 13942 | 3.4 | 1525 | 2.5 | 1455 | 3.1 | 1809 | 3.2 | 2007Z | 3.1 | 20186 | 2.5 | 205458 | 2.42 |
| 13943 | 3.4 | 1527 | 2.5 | 1456 | 3.1 | 1809 | 3.2 | 2008 | 3.1 | 20187 | 2.5 | 205459 | 2.42 |
| 13952 | 3.4 | 1528 | 2.5 | 1456 | 3.1 | 1809 | 3.2 | 2008A | 3.1 | 20188 | 2.5 | 205460 | 2.42 |
| 13953 | 3.4 | 1529 | 2.5 | 1456 | 3.1 | 1809 | 3.2 | 2008B | 3.1 | 20189 | 2.5 | 205461 | 2.42 |
| 13953M | 3.4 | 1528 | 2.5 | 1457 | 3.1 | 1809 | 3.2 | 2008C | 3.1 | 20190 | 2.5 | 205462 | 2.42 |
| 13954 | 3.7 | 1528 | 2.5 | 1457 | 3.1 | 1809 | 3.2 | 2008D | 3.1 | 20191 | 2.5 | 205463 | 2.42 |
| 13955 | 3.7 | 1528 | 2.5 | 1457 | 3.1 | 1809 | 3.2 | 2008E | 3.1 | 20192 | 2.5 | 205464 | 2.42 |
| 13955M | 3.7 | 1528 | 2.5 | 1457 | 3.1 | 1809 | 3.2 | 2008F | 3.1 | 20193 | 2.5 | 205465 | 2.42 |
| 13960 | 3.4 | 1530 | 2.5 | 1459 | 3.1 | 1809 | 3.2 | 2008G | 3.1 | 20194 | 2.5 | 205466 | 2.42 |
| 13962 | 3.4 | 1532 | 2.5 | 1460 | 3.1 | 1809 | 3.2 | 2008H | 3.1 | 20195 | 2.5 | 205467 | 2.42 |
| 14000 | 3.7 | 1533 | 2.5 | 1460 | 3.1 | 1809 | 3.2 | 2008I | 3.1 | 20196 | 2.5 | 205468 | 2.42 |
| 14001 | 3.7 | 1533 | 2.5 | 1460 | 3.1 | 1809 | 3.2 | 2008J | 3.1 | 20197 | 2.5 | 205469 | 2.42 |
| 14002 | 3.7 | 1533 | 2.5 | 1460 | 3.1 | 1809 | 3.2 | 2008K | 3.1 | 20198 | 2.5 | 205470 | 2.42 |
| 14003 | 3.7 | 1533 | 2.5 | 1460 | 3.1 | 1809 | 3.2 | 2008L | 3.1 | 20199 | 2.5 | 205471 | 2.42 |
| 14004 | 3.7 | 1533 | 2.5 | 1460 | 3.1 | 1809 | 3.2 | 2008M | 3.1 | 20200 | 2.5 | 205472 | 2.42 |
| 14005 | 3.7 | 1533 | 2.5 | 1460 | 3.1 | 1809 | 3.2 | 2008N | 3.1 | 20201 | 2.5 | 205473 | 2.42 |
| 14006 | 3.7 | 1533 | 2.5 | 1460 | 3.1 | 1809 | 3.2 | 2008O | 3.1 | 20202 | 2.5 | 205474 | 2.42 |
| 14007 | 3.7 | 1533 | 2.5 | 1460 | 3.1 | 1809 | 3.2 | 2008P | 3.1 | 20203 | 2.5 | 205475 | 2.42 |
| 14008 | 3.7 | 1533 | 2.5 | 1460 | 3.1 | 1809 | 3.2 | 2008Q | 3.1 | 20204 | 2.5 | 205476 | 2.42 |
| 14009 | 3.7 | 1533 | 2.5 | 1460 | 3.1 | 1809 | 3.2 | 2008R | 3.1 | 20205 | 2.5 | 205477 | 2.42 |
| 14010 | 3.7 | 1533 | 2.5 | 1460 | 3.1 | 1809 | 3.2 | 2008S | 3.1 | 20206 | 2.5 | 205478 | 2.42 |
| 14011 | 3.7 | 1533 | 2.5 | 1460 | 3.1 | 1809 | 3.2 | 2008T | 3.1 | 20207 | 2.5 | 205479 | 2.42 |
| 14012 | 3.7 | 1533 | 2.5 | 1460 | 3.1 | 1809 | 3.2 | 2008U | 3.1 | 20208 | 2.5 | 205480 | 2.42 |
| 14013 | 3.7 | 1533 | 2.5 | 1460 | 3.1 | 1809 | 3.2 | 2008V | 3.1 | 20209 | 2.5 | 205481 | 2.42 |
| 14014 | 3.7 | 1533 | 2.5 | 1460 | 3.1 | 1809 | 3.2 | 2008W | 3.1 | 20210 | 2.5 | 205482 | 2.42 |
| 14015 | 3.7 | 1533 | 2.5 | 1460 | 3.1 | 1809 | 3.2 | 2008X | 3.1 | 20211 | 2.5 | 205483 | 2.42 |
| 14016 | 3.7 | 1533 | 2.5 | 1460 | 3.1 | 1809 | 3.2 | 2008Y | 3.1 | 20212 | 2.5 | 205484 | 2.42 |
| 14017 | 3.7 | 1533 | 2.5 | 1460 | 3.1 | 1809 | 3.2 | 2008Z | 3.1 | 20213 | 2.5 | 205485 | 2.42 |
| 14018 | 3.7 | 1533 | 2.5 | 1460 | 3.1 | 1809 | 3.2 | 2009 | 3.1 | 20214 | 2.5 | 205486 | 2.42 |
| 14019 | 3.7 | 1533 | 2.5 | 1460 | 3.1 | 1809 | 3.2 | 2009A | 3.1 | 20215 | 2.5 | 205487 | 2.42 |
| 14020 | 3.7 | 1533 | 2.5 | 1460 | 3.1 | 1809 | 3.2 | 2009B | 3.1 | 20216 | 2.5 | 205488 | 2.42 |
| 14021 | 3.7 | 1533 | 2.5 | 1460 | 3.1 | 1809 | 3.2 | 2009C | 3.1 | 20217 | 2.5 | 205489 | 2.42 |
| 14022 | 3.7 | 1533 | 2.5 | 1460 | 3.1 | 1809 | 3.2 | 2009D | 3.1 | 20218 | 2.5 | 205490 | 2.42 |
| 14023 | 3.7 | 1533 | 2.5 | 1460 | 3.1 | 1809 | 3.2 | 2009E | 3.1 | 20219 | 2.5 | 205491 | 2.42 |
| 14024 | 3.7 | 1533 | 2.5 | 1460 | 3.1 | 1809 | 3.2 | 2009F | 3.1 | 20220 | 2.5 | 205492 | 2.42 |
| 14025 | 3.7 | 1533 | 2.5 | 1460 | 3.1 | 1809 | 3.2 | 2009G | 3.1 | 20221 | 2.5 | 205493 | 2.42 |
| 14026 | 3.7 | 1533 | 2.5 | 1460 | 3.1 | 1809 | 3.2 | 2009H | 3.1 | 20222 | 2.5 | 205494 | 2.42 |
| 14027 | 3.7 | 1533 | 2.5 | 1460 | 3.1 | 1809 | 3.2 | 2009I | 3.1 | 20223 | 2.5 | 205495 | 2.42 |
| 14028 | 3.7 | 1533 | 2.5 | 1460 | 3.1 | 1809 | 3.2 | 2009J | 3.1 | 20224 | 2.5 | 205496 | 2.42 |
| 14029 | 3.7 | 1533 | 2.5 | 1460 | 3.1 | 1809 | 3.2 | 2009K | 3.1 | 20225 | 2.5 | 205497 | 2.42 |
| 14030 | 3.7 | 1533 | 2.5 | 1460 | 3.1 | 1809 | 3.2 | 2009L | 3.1 | 20226 | 2.5 | 205498 | 2.42 |
| 14031 | 3.7 | 1533 | 2.5 | 1460 | 3.1 | 1809 | 3.2 | 2009M | 3.1 | 20227 | 2.5 | 205499 | 2.42 |
| 14032 | 3.7 | 1533 | 2.5 | 1460 | 3.1 | 1809 | 3.2 | 2009N | 3.1 | 20228 | 2.5 | 205500 | 2.42 |
| 14033 | 3.7 | 1533 | 2.5 | 1460 | 3.1 | 1809 | 3.2 | 2009O | 3.1 | 20229 | 2.5 | 205501 | 2.42 |
| 14034 | 3.7 | 1533 | 2.5 | 1460 | 3.1 | 1809 | 3.2 | 2009P | 3.1 | 20230 | 2.5 | 205502 | 2.42 |
| 14035 | 3.7 | 1533 | 2.5 | 1460 | 3.1 | 1809 | 3.2 | 2009Q | 3.1 | 20231 | 2.5 | 205503 | 2.42 |
| 14036 | 3.7 | 1533 | 2.5 | 1460 | 3.1 | 1809 | 3.2 | 2009R | 3.1 | 20232 | 2.5 | 205504 | 2.42 |
| 14037 | 3.7 | 1533 | 2.5 | 1460 | 3.1 | 1809 | 3.2 | 2009S | 3.1 | 20233 | 2.5 | 205505 | 2.42 |
| 14038 | 3.7 | 1533 | 2.5 | 1460 | 3.1 | 1809 | 3.2 | 2009T | 3.1 | 20234 | 2.5 | 205506 | 2.42 |
| 14039 | 3.7 | 1533 | 2.5 | 1460 | 3.1 | 1809 | 3.2 | 2009U | 3.1 | 20235 | 2.5 | 205507 | 2.42 |
| 14040 | 3.7 | 1533 | 2.5 | 1460 | 3.1 | 1809 | 3.2 | 2009V | 3.1 | 20236 | 2.5 | 205508 | 2.42 |
| 14041 | 3.7 | 1533 | 2.5 | 1460 | 3.1 | 1809 | 3.2 | 2009W | 3.1 | 20237 | 2.5 | 205509 | 2.42 |
| 14042 | 3.7 | 1533 | 2.5 | 1460 | 3.1 | 1809 | 3.2 | 2009X | 3.1 | 20238 | 2.5 | 205510 | 2.42 |
| 14043 | 3.7 | 1533 | 2.5 | 1460 | 3.1 | 1809 | 3.2 | 2009Y | 3.1 | 20239 | 2.5 | 205511 | 2.42 |
| 14044 | 3.7 | 1533 | 2.5 | 1460 | 3.1 | 1809 | 3.2 | 2009Z | 3.1 | 20240 | 2.5 | 205512 | 2.42 |
| 14045 | 3.7 | 1533 | 2.5 | 1460 | 3.1 | 1809 | 3.2 | 2010 | 3.1 | 20241 | 2.5 | 205513 | 2.42 |
| 14046 | 3.7 | 1533 | 2.5 | 1460 | 3.1 | 1809 | 3.2 | 2010A | 3.1 | 20242 | 2.5 | 205514 | 2.42 |
| 14047 | 3.7 | 1533 | 2.5 | 1460 | 3.1 | 1809 | 3.2 | 2010B | 3.1 | 20243 | 2.5 | 205515 | 2.42 |
| 14048 | 3.7 | 1533 | 2.5 | 1460 | 3.1 | 1809 | 3.2 | 2010C | 3.1 | 20244 | 2.5 | 205516 | 2.42 |
| 14049 | 3.7 | 1533 | 2.5 | 1460 | 3.1 | 1809 | 3.2 | 2010D | 3.1 | 20245 | 2.5 | 205517 | 2.42 |
| 14050 | 3.7 | 1533 | 2.5 | 1460 | 3.1 | 1809 | 3.2 | 2010E | 3.1 | 20246 | 2.5 | 205518 | 2.42 |
| 14051 | 3.7 | 1533 | 2.5 | 1460 | 3.1 | 1809 | 3.2 | 2010F | 3.1 | 20247 | 2.5 | 205519 | 2.42 |
| 14052 | 3.7 | 1533 | 2.5 | 1460 | 3.1 | 1809 | 3.2 | 2010G | 3.1 | 20248 | 2.5 | 205520 | 2.42 |
| 14053 | 3.7 | 1533 | 2.5 | 1460 | 3.1 | 1809 | 3.2 | 2010H | 3.1 | 20249 | 2.5 | 205521 | 2.42 |
| 14054 | 3.7 | 1533 | 2.5 | 1460 | 3.1 | 1809 | 3.2 | 2010I | 3.1 | 20250 | 2.5 | | |

| | | | | | | | | | | | | | |
|------|----|-------|----|------|----|------|----|------|----|------|----|-------|----|
| 2119 | 21 | 21650 | 21 | 2191 | 21 | 2126 | 21 | 2141 | 21 | 2116 | 21 | 21060 | 21 |
| 2120 | 21 | 21651 | 21 | 2192 | 21 | 2127 | 21 | 2142 | 21 | 2117 | 21 | 21061 | 21 |
| 2121 | 21 | 21652 | 21 | 2193 | 21 | 2128 | 21 | 2143 | 21 | 2118 | 21 | 21062 | 21 |
| 2122 | 21 | 21653 | 21 | 2194 | 21 | 2129 | 21 | 2144 | 21 | 2119 | 21 | 21063 | 21 |
| 2123 | 21 | 21654 | 21 | 2195 | 21 | 2130 | 21 | 2145 | 21 | 2120 | 21 | 21064 | 21 |
| 2124 | 21 | 21655 | 21 | 2196 | 21 | 2131 | 21 | 2146 | 21 | 2121 | 21 | 21065 | 21 |
| 2125 | 21 | 21656 | 21 | 2197 | 21 | 2132 | 21 | 2147 | 21 | 2122 | 21 | 21066 | 21 |
| 2126 | 21 | 21657 | 21 | 2198 | 21 | 2133 | 21 | 2148 | 21 | 2123 | 21 | 21067 | 21 |
| 2127 | 21 | 21658 | 21 | 2199 | 21 | 2134 | 21 | 2149 | 21 | 2124 | 21 | 21068 | 21 |
| 2128 | 21 | 21659 | 21 | 2200 | 21 | 2135 | 21 | 2150 | 21 | 2125 | 21 | 21069 | 21 |
| 2129 | 21 | 21660 | 21 | 2201 | 21 | 2136 | 21 | 2151 | 21 | 2126 | 21 | 21070 | 21 |
| 2130 | 21 | 21661 | 21 | 2202 | 21 | 2137 | 21 | 2152 | 21 | 2127 | 21 | 21071 | 21 |
| 2131 | 21 | 21662 | 21 | 2203 | 21 | 2138 | 21 | 2153 | 21 | 2128 | 21 | 21072 | 21 |
| 2132 | 21 | 21663 | 21 | 2204 | 21 | 2139 | 21 | 2154 | 21 | 2129 | 21 | 21073 | 21 |
| 2133 | 21 | 21664 | 21 | 2205 | 21 | 2140 | 21 | 2155 | 21 | 2130 | 21 | 21074 | 21 |
| 2134 | 21 | 21665 | 21 | 2206 | 21 | 2141 | 21 | 2156 | 21 | 2131 | 21 | 21075 | 21 |
| 2135 | 21 | 21666 | 21 | 2207 | 21 | 2142 | 21 | 2157 | 21 | 2132 | 21 | 21076 | 21 |
| 2136 | 21 | 21667 | 21 | 2208 | 21 | 2143 | 21 | 2158 | 21 | 2133 | 21 | 21077 | 21 |
| 2137 | 21 | 21668 | 21 | 2209 | 21 | 2144 | 21 | 2159 | 21 | 2134 | 21 | 21078 | 21 |
| 2138 | 21 | 21669 | 21 | 2210 | 21 | 2145 | 21 | 2160 | 21 | 2135 | 21 | 21079 | 21 |
| 2139 | 21 | 21670 | 21 | 2211 | 21 | 2146 | 21 | 2161 | 21 | 2136 | 21 | 21080 | 21 |
| 2140 | 21 | 21671 | 21 | 2212 | 21 | 2147 | 21 | 2162 | 21 | 2137 | 21 | 21081 | 21 |
| 2141 | 21 | 21672 | 21 | 2213 | 21 | 2148 | 21 | 2163 | 21 | 2138 | 21 | 21082 | 21 |
| 2142 | 21 | 21673 | 21 | 2214 | 21 | 2149 | 21 | 2164 | 21 | 2139 | 21 | 21083 | 21 |
| 2143 | 21 | 21674 | 21 | 2215 | 21 | 2150 | 21 | 2165 | 21 | 2140 | 21 | 21084 | 21 |
| 2144 | 21 | 21675 | 21 | 2216 | 21 | 2151 | 21 | 2166 | 21 | 2141 | 21 | 21085 | 21 |
| 2145 | 21 | 21676 | 21 | 2217 | 21 | 2152 | 21 | 2167 | 21 | 2142 | 21 | 21086 | 21 |
| 2146 | 21 | 21677 | 21 | 2218 | 21 | 2153 | 21 | 2168 | 21 | 2143 | 21 | 21087 | 21 |
| 2147 | 21 | 21678 | 21 | 2219 | 21 | 2154 | 21 | 2169 | 21 | 2144 | 21 | 21088 | 21 |
| 2148 | 21 | 21679 | 21 | 2220 | 21 | 2155 | 21 | 2170 | 21 | 2145 | 21 | 21089 | 21 |
| 2149 | 21 | 21680 | 21 | 2221 | 21 | 2156 | 21 | 2171 | 21 | 2146 | 21 | 21090 | 21 |
| 2150 | 21 | 21681 | 21 | 2222 | 21 | 2157 | 21 | 2172 | 21 | 2147 | 21 | 21091 | 21 |
| 2151 | 21 | 21682 | 21 | 2223 | 21 | 2158 | 21 | 2173 | 21 | 2148 | 21 | 21092 | 21 |
| 2152 | 21 | 21683 | 21 | 2224 | 21 | 2159 | 21 | 2174 | 21 | 2149 | 21 | 21093 | 21 |
| 2153 | 21 | 21684 | 21 | 2225 | 21 | 2160 | 21 | 2175 | 21 | 2150 | 21 | 21094 | 21 |
| 2154 | 21 | 21685 | 21 | 2226 | 21 | 2161 | 21 | 2176 | 21 | 2151 | 21 | 21095 | 21 |
| 2155 | 21 | 21686 | 21 | 2227 | 21 | 2162 | 21 | 2177 | 21 | 2152 | 21 | 21096 | 21 |
| 2156 | 21 | 21687 | 21 | 2228 | 21 | 2163 | 21 | 2178 | 21 | 2153 | 21 | 21097 | 21 |
| 2157 | 21 | 21688 | 21 | 2229 | 21 | 2164 | 21 | 2179 | 21 | 2154 | 21 | 21098 | 21 |
| 2158 | 21 | 21689 | 21 | 2230 | 21 | 2165 | 21 | 2180 | 21 | 2155 | 21 | 21099 | 21 |
| 2159 | 21 | 21690 | 21 | 2231 | 21 | 2166 | 21 | 2181 | 21 | 2156 | 21 | 21100 | 21 |
| 2160 | 21 | 21691 | 21 | 2232 | 21 | 2167 | 21 | 2182 | 21 | 2157 | 21 | 21101 | 21 |
| 2161 | 21 | 21692 | 21 | 2233 | 21 | 2168 | 21 | 2183 | 21 | 2158 | 21 | 21102 | 21 |
| 2162 | 21 | 21693 | 21 | 2234 | 21 | 2169 | 21 | 2184 | 21 | 2159 | 21 | 21103 | 21 |
| 2163 | 21 | 21694 | 21 | 2235 | 21 | 2170 | 21 | 2185 | 21 | 2160 | 21 | 21104 | 21 |
| 2164 | 21 | 21695 | 21 | 2236 | 21 | 2171 | 21 | 2186 | 21 | 2161 | 21 | 21105 | 21 |
| 2165 | 21 | 21696 | 21 | 2237 | 21 | 2172 | 21 | 2187 | 21 | 2162 | 21 | 21106 | 21 |
| 2166 | 21 | 21697 | 21 | 2238 | 21 | 2173 | 21 | 2188 | 21 | 2163 | 21 | 21107 | 21 |
| 2167 | 21 | 21698 | 21 | 2239 | 21 | 2174 | 21 | 2189 | 21 | 2164 | 21 | 21108 | 21 |
| 2168 | 21 | 21699 | 21 | 2240 | 21 | 2175 | 21 | 2190 | 21 | 2165 | 21 | 21109 | 21 |
| 2169 | 21 | 21700 | 21 | 2241 | 21 | 2176 | 21 | 2191 | 21 | 2166 | 21 | 21110 | 21 |
| 2170 | 21 | 21701 | 21 | 2242 | 21 | 2177 | 21 | 2192 | 21 | 2167 | 21 | 21111 | 21 |
| 2171 | 21 | 21702 | 21 | 2243 | 21 | 2178 | 21 | 2193 | 21 | 2168 | 21 | 21112 | 21 |
| 2172 | 21 | 21703 | 21 | 2244 | 21 | 2179 | 21 | 2194 | 21 | 2169 | 21 | 21113 | 21 |
| 2173 | 21 | 21704 | 21 | 2245 | 21 | 2180 | 21 | 2195 | 21 | 2170 | 21 | 21114 | 21 |
| 2174 | 21 | 21705 | 21 | 2246 | 21 | 2181 | 21 | 2196 | 21 | 2171 | 21 | 21115 | 21 |
| 2175 | 21 | 21706 | 21 | 2247 | 21 | 2182 | 21 | 2197 | 21 | 2172 | 21 | 21116 | 21 |
| 2176 | 21 | 21707 | 21 | 2248 | 21 | 2183 | 21 | 2198 | 21 | 2173 | 21 | 21117 | 21 |
| 2177 | 21 | 21708 | 21 | 2249 | 21 | 2184 | 21 | 2199 | 21 | 2174 | 21 | 21118 | 21 |
| 2178 | 21 | 21709 | 21 | 2250 | 21 | 2185 | 21 | 2200 | 21 | 2175 | 21 | 21119 | 21 |
| 2179 | 21 | 21710 | 21 | 2251 | 21 | 2186 | 21 | 2201 | 21 | 2176 | 21 | 21120 | 21 |
| 2180 | 21 | 21711 | 21 | 2252 | 21 | 2187 | 21 | 2202 | 21 | 2177 | 21 | 21121 | 21 |
| 2181 | 21 | 21712 | 21 | 2253 | 21 | 2188 | 21 | 2203 | 21 | 2178 | 21 | 21122 | 21 |
| 2182 | 21 | 21713 | 21 | 2254 | 21 | 2189 | 21 | 2204 | 21 | 2179 | 21 | 21123 | 21 |
| 2183 | 21 | 21714 | 21 | 2255 | 21 | 2190 | 21 | 2205 | 21 | 2180 | 21 | 21124 | 21 |
| 2184 | 21 | 21715 | 21 | 2256 | 21 | 2191 | 21 | 2206 | 21 | 2181 | 21 | 21125 | 21 |
| 2185 | 21 | 21716 | 21 | 2257 | 21 | 2192 | 21 | 2207 | 21 | 2182 | 21 | 21126 | 21 |
| 2186 | 21 | 21717 | 21 | 2258 | 21 | 2193 | 21 | 2208 | 21 | 2183 | 21 | 21127 | 21 |
| 2187 | 21 | 21718 | 21 | 2259 | 21 | 2194 | 21 | 2209 | 21 | 2184 | 21 | 21128 | 21 |
| 2188 | 21 | 21719 | 21 | 2260 | 21 | 2195 | 21 | 2210 | 21 | 2185 | 21 | 21129 | 21 |
| 2189 | 21 | 21720 | 21 | 2261 | 21 | 2196 | 21 | 2211 | 21 | 2186 | 21 | 21130 | 21 |
| 2190 | 21 | 21721 | 21 | 2262 | 21 | 2197 | 21 | 2212 | 21 | 2187 | 21 | 21131 | 21 |
| 2191 | 21 | 21722 | 21 | 2263 | 21 | 2198 | 21 | 2213 | 21 | 2188 | 21 | 21132 | 21 |
| 2192 | 21 | 21723 | 21 | 2264 | 21 | 2199 | 21 | 2214 | 21 | 2189 | 21 | 21133 | 21 |
| 2193 | 21 | 21724 | 21 | 2265 | 21 | 2200 | 21 | 2215 | 21 | 2190 | 21 | 21134 | 21 |
| 2194 | 21 | 21725 | 21 | 2266 | 21 | 2201 | 21 | 2216 | 21 | 2191 | 21 | 21135 | 21 |
| 2195 | 21 | 21726 | 21 | 2267 | 21 | 2202 | 21 | 2217 | 21 | 2192 | 21 | 21136 | 21 |
| 2196 | 21 | 21727 | 21 | 2268 | 21 | 2203 | 21 | 2218 | 21 | 2193 | 21 | 21137 | 21 |
| 2197 | 21 | 21728 | 21 | 2269 | 21 | 2204 | 21 | 2219 | 21 | 2194 | 21 | 21138 | 21 |
| 2198 | 21 | 21729 | 21 | 2270 | 21 | 2205 | 21 | 2220 | 21 | 2195 | 21 | 21139 | 21 |
| 2199 | 21 | 21730 | 21 | 2271 | 21 | 2206 | 21 | 2221 | 21 | 2196 | 21 | 21140 | 21 |
| 2200 | 21 | 21731 | 21 | 2272 | 21 | 2207 | 21 | 2222 | 21 | 2197 | 21 | 21141 | 21 |
| 2201 | 21 | 21732 | 21 | 2273 | 21 | 2208 | 21 | 2223 | 21 | 2198 | 21 | 21142 | 21 |
| 2202 | 21 | 21733 | 21 | 2274 | 21 | 2209 | 21 | 2224 | 21 | 2199 | 21 | 21143 | 21 |
| 2203 | 21 | 21734 | 21 | 2275 | 21 | 2210 | 21 | 2225 | 21 | 2200 | 21 | 21144 | 21 |
| 2204 | 21 | 21735 | 21 | 2276 | 21 | 2211 | 21 | 2226 | 21 | 2201 | 21 | 21145 | 21 |
| 2205 | 21 | 21736 | 21 | 2277 | 21 | 2212 | 21 | 2227 | 21 | 2202 | 21 | 21146 | 21 |
| 2206 | 21 | 21737 | 21 | 2278 | 21 | 2213 | 21 | 2228 | 21 | 2203 | 21 | 21147 | 21 |
| 2207 | 21 | 21738 | 21 | 2279 | 21 | 2214 | 21 | 2229 | 21 | 2204 | 21 | 21148 | 21 |
| 2208 | 21 | 21739 | 21 | 2280 | 21 | 2215 | 21 | 2230 | 21 | 2205 | 21 | 21149 | 21 |
| 2209 | 21 | 21740 | 21 | 2281 | 21 | 2216 | 21 | 2231 | 21 | 2206 | 21 | 21150 | 21 |
| 2210 | 21 | 21741 | 21 | 2282 | 21 | 2217 | 21 | 2232 | 21 | 2207 | 21 | 21151 | 21 |
| 2211 | 21 | 21742 | 21 | 2283 | 21 | 2218 | 21 | 2233 | 21 | 2208 | 21 | 21152 | 21 |
| 2212 | 21 | 21743 | 21 | 2284 | 21 | 2219 | 21 | 2234 | 21 | 2209 | 21 | 21153 | 21 |
| 2213 | 21 | 21744 | 21 | 2285 | 21 | 2220 | 21 | 2235 | 21 | 2210 | 21 | 21154 | 21 |
| 2214 | 21 | 21745 | 21 | 2286 | 21 | 2221 | 21 | 2236 | 21 | 2211 | 21 | 21155 | 21 |
| 2215 | 21 | 21746 | 21 | 2287 | 21 | 2222 | 21 | 2237 | 21 | 2212 | 21 | 21156 | 21 |
| 2216 | 21 | 21747 | 21 | 2288 | 21 | 2223 | 21 | 2238 | 21 | 2213 | 21 | 21157 | 21 |
| 2217 | 21 | 21748 | 21 | 2289 | 21 | 2224 | 21 | 2239 | 21 | 2214 | 21 | 21158 | 21 |
| 2218 | 21 | 21749 | 21 | 2290 | 21 | 2225 | 21 | 2240 | 21 | 2215 | 21 | 21159 | 21 |
| 2219 | 21 | 21750 | 21 | 2291 | 21 | 2226 | 21 | 2241 | 21 | 2216 | 21 | 21160 | 21 |
| 2220 | 21 | 21751 | 21 | 2292 | 21 | 2227 | 21 | 2242 | 21 | 2217 | 21 | 21161 | 21 |
| 2221 | 21 | 21752 | 21 | 2293 | 21 | 2228 | 21 | 224 | | | | | |

| | | | | | | | | | | | | | |
|------|------|-----------|------|-------|------|--------|------|-------|-----|-------|-----|---------|------|
| 4802 | 2.1 | 5040205 | 4.1 | 53501 | 3.5 | 552230 | 2.2 | 64103 | 1.4 | 69404 | 5.8 | 69814 | 6.9 |
| 4803 | 1.21 | 504031 | 4.12 | 53509 | 1.1 | 552231 | 1.1 | 64105 | 1.4 | 69410 | 1.4 | 69815 | 6.9 |
| 4804 | 1.1 | 504124 | 4.8 | 53514 | 1.12 | 552232 | 1.26 | 64106 | 1.2 | 69411 | 6.5 | 69816 | 6.9 |
| 4806 | 1.21 | 506032 | 4.24 | 5351 | 1.1 | 552231 | 1.1 | 64107 | 1 | 69490 | 1.2 | 69817 | 6.17 |
| 4808 | 1.21 | 506033 | 4.12 | 5354 | 1.21 | 552232 | 1.21 | 64108 | 1 | 69411 | 1.4 | 69818 | 6.17 |
| 4812 | 1.21 | 506014 | 4.8 | 54 | 1.6 | 552222 | 1 | 64109 | 1 | 69412 | 6.4 | 69819 | 6.17 |
| 4813 | 1.21 | 506025 | 4.22 | 55 | 1.21 | 552411 | 1 | 64110 | 1 | 69490 | 1.1 | 69820 | 6.17 |
| 4814 | 1.21 | 506036 | 4.12 | 5401 | 1.1 | 59201 | 1.2 | 64111 | 1 | 69411 | 1.2 | 7-10921 | 1 |
| 4815 | 1.21 | 506037 | 4.1 | 53500 | 1.1 | 59202 | 1.1 | 64112 | 1 | 69701 | 1.2 | 7-1091 | 1.2 |
| 4816 | 1.21 | 506058 | 4.1 | 53501 | 1.1 | 59201 | 1.1 | 64201 | 1.1 | 69701 | 1.1 | 7-191 | 1.2 |
| 4817 | 1.21 | 506059 | 4.14 | 53522 | 1.1 | 59205 | 1.1 | 6420 | 1.1 | 69704 | 1.1 | 7-194 | 1.2 |
| 4818 | 1.21 | 506060 | 4.11 | 53524 | 1.1 | 59204 | 1.1 | 6421 | 1.1 | 69705 | 1.1 | 7-195 | 1.2 |
| 4819 | 1.21 | 506043 | 4.2 | 53524 | 1.1 | 59270 | 1.1 | 6422 | 1.1 | 69706 | 1.1 | 7-196 | 1.2 |
| 4820 | 1.21 | 506070 | 4.8 | 53526 | 1.1 | 59275 | 1.1 | 6423 | 1.1 | 69707 | 1.1 | 7-198 | 1.2 |
| 4822 | 1.21 | 506072 | 4.6 | 53527 | 1.1 | 59280 | 1.1 | 6424 | 1.1 | 69708 | 1.1 | 7-201 | 1.2 |
| 4828 | 1.21 | 506075 | 4.8 | 53528 | 1.1 | 59281 | 1.1 | 6425 | 1.1 | 69709 | 1.1 | 7-204 | 1.2 |
| 4829 | 1.21 | 506080 | 4.7 | 53529 | 1.1 | 59283 | 1.1 | 6426 | 1.1 | 69710 | 1.1 | 7-205 | 1.2 |
| 4830 | 1.21 | 536090 | 4.8 | 53530 | 1.1 | 59284 | 1.1 | 6427 | 1.1 | 69711 | 1.1 | 7-206 | 1.2 |
| 4831 | 1.21 | 506095 | 4.1 | 53531 | 1.1 | 59285 | 1.1 | 6428 | 1.1 | 69712 | 1.1 | 7-208 | 1.2 |
| 4832 | 1.21 | 5061044 | 4.12 | 53532 | 1.1 | 59300 | 1.1 | 6429 | 1.1 | 69713 | 1.1 | 7-210 | 1.2 |
| 4833 | 1.21 | 50612041 | 4.1 | 53534 | 1.1 | 59305 | 1.1 | 6430 | 1.1 | 69714 | 1.1 | 7-211 | 1.2 |
| 4834 | 1.21 | 506130787 | 4.1 | 53534 | 1.1 | 59310 | 1.1 | 6430 | 1.1 | 69715 | 1.1 | 7-215 | 1.2 |
| 4835 | 1.21 | 50610041 | 4.1 | 53534 | 1.1 | 59315 | 1.1 | 6431 | 1.1 | 69716 | 1.1 | 7-216 | 1.2 |
| 4836 | 1.21 | 101 | 1.1 | 53536 | 1.1 | 59300 | 1.1 | 6432 | 1.1 | 69717 | 1.1 | 7-218 | 1.2 |
| 4837 | 1.21 | 509300 | 4.1 | 53536 | 1.1 | 59301 | 1.1 | 6433 | 1.1 | 69718 | 1.1 | 7-219 | 1.2 |
| 4840 | 1.21 | 509310 | 4.1 | 53538 | 1.1 | 59302 | 1.1 | 6434 | 1.1 | 69719 | 1.1 | 7-219 | 1.2 |
| 4841 | 1.21 | 509300 | 4.1 | 53538 | 1.1 | 59301 | 1.1 | 6435 | 1.1 | 69720 | 1.1 | 7-219 | 1.2 |
| 4842 | 1.21 | 53 | 1.14 | 53530 | 1.1 | 53530 | 1.1 | 6436 | 1.1 | 69721 | 1.1 | 7-219 | 1.2 |
| 4843 | 1.21 | 100 | 1.1 | 53532 | 1.1 | 53535 | 1.1 | 6437 | 1.1 | 69722 | 1.1 | 7-219 | 1.2 |
| 4844 | 1.21 | 1000 | 1.1 | 53534 | 1.1 | 6000 | 1.1 | 6438 | 1.1 | 69723 | 1.1 | 7-219 | 1.2 |
| 4845 | 1.21 | 10100 | 1.1 | 53536 | 1.1 | 6000 | 1.1 | 6439 | 1.1 | 69724 | 1.1 | 7-219 | 1.2 |
| 4846 | 1.21 | 50112 | 1.24 | 53530 | 1.1 | 6000 | 1.1 | 6440 | 1.1 | 69725 | 1.1 | 7-219 | 1.2 |
| 4847 | 1.21 | 10011 | 1.1 | 53537 | 1.1 | 6000 | 1.1 | 6441 | 1.1 | 69726 | 1.1 | 7-219 | 1.2 |
| 4851 | 1.21 | 53040 | 1.1 | 53534 | 1.1 | 600 | 1.1 | 6442 | 1.1 | 69727 | 1.1 | 7-219 | 1.2 |
| 4852 | 1.21 | 501 | 1.1 | 53536 | 1.1 | 6054 | 1.1 | 6443 | 1.1 | 69728 | 1.1 | 7-219 | 1.2 |
| 4853 | 1.21 | 50114 | 1.1 | 53538 | 1.1 | 606 | 1.1 | 6444 | 1.1 | 69729 | 1.1 | 7-219 | 1.2 |
| 4857 | 1.21 | 53115 | 1.1 | 53540 | 1.1 | 607 | 1.1 | 6445 | 1.1 | 69730 | 1.1 | 7-219 | 1.2 |
| 4859 | 1.21 | 51120 | 1.14 | 53540 | 1.1 | 608 | 1.1 | 6446 | 1.1 | 69731 | 1.1 | 7-219 | 1.2 |
| 4864 | 1.1 | 1014 | 1.1 | 53540 | 1.1 | 608 | 1.1 | 6447 | 1.1 | 69732 | 1.1 | 7-219 | 1.2 |
| 4865 | 1.1 | 1016 | 1.1 | 53542 | 1.1 | 608 | 1.1 | 6448 | 1.1 | 69733 | 1.1 | 7-219 | 1.2 |
| 4866 | 1.1 | 5118 | 1.1 | 53520 | 1.1 | 608 | 1.1 | 6449 | 1.1 | 69734 | 1.1 | 7-219 | 1.2 |
| 4868 | 1.21 | 5019 | 1.1 | 53540 | 1.1 | 608 | 1.1 | 6450 | 1.1 | 69735 | 1.1 | 7-219 | 1.2 |
| 4870 | 1.1 | 5020 | 1.1 | 53545 | 1.1 | 608 | 1.1 | 6451 | 1.1 | 69736 | 1.1 | 7-219 | 1.2 |
| 4882 | 1.1 | 5021 | 1.1 | 53546 | 1.1 | 608 | 1.1 | 6452 | 1.1 | 69737 | 1.1 | 7-219 | 1.2 |
| 4883 | 1.1 | 5021 | 1.1 | 53546 | 1.1 | 608 | 1.1 | 6453 | 1.1 | 69738 | 1.1 | 7-219 | 1.2 |
| 4887 | 1.1 | 1026 | 1.1 | 53547 | 1.1 | 6100 | 1.1 | 6454 | 1.1 | 69739 | 1.1 | 7-219 | 1.2 |
| 4888 | 1.21 | 5028 | 1.1 | 53548 | 1.1 | 6100 | 1.1 | 6455 | 1.1 | 69740 | 1.1 | 7-219 | 1.2 |
| 4889 | 1.1 | 5130 | 1.1 | 53549 | 1.1 | 6101 | 1.1 | 6456 | 1.1 | 69741 | 1.1 | 7-219 | 1.2 |
| 4890 | 1.1 | 5031 | 1.1 | 53550 | 1.1 | 6101 | 1.1 | 6457 | 1.1 | 69742 | 1.1 | 7-219 | 1.2 |
| 4891 | 1.1 | 5031 | 1.1 | 53550 | 1.1 | 6101 | 1.1 | 6458 | 1.1 | 69743 | 1.1 | 7-219 | 1.2 |
| 4896 | 1.1 | 5033 | 1.1 | 53552 | 1.1 | 6102 | 1.1 | 6459 | 1.1 | 69744 | 1.1 | 7-219 | 1.2 |
| 490 | 1.1 | 5134 | 1.1 | 53553 | 1.1 | 6102 | 1.1 | 6460 | 1.1 | 69745 | 1.1 | 7-219 | 1.2 |
| 4904 | 1.1 | 5035 | 1.1 | 53554 | 1.1 | 6103 | 1.1 | 6461 | 1.1 | 69746 | 1.1 | 7-219 | 1.2 |
| 4910 | 1.1 | 5136 | 1.1 | 53555 | 1.1 | 6103 | 1.1 | 6462 | 1.1 | 69747 | 1.1 | 7-219 | 1.2 |
| 4915 | 1.1 | 5137 | 1.1 | 53556 | 1.1 | 6103 | 1.1 | 6463 | 1.1 | 69748 | 1.1 | 7-219 | 1.2 |
| 4916 | 1.1 | 5138 | 1.1 | 53557 | 1.1 | 6104 | 1.1 | 6464 | 1.1 | 69749 | 1.1 | 7-219 | 1.2 |
| 4917 | 1.1 | 5139 | 1.1 | 53558 | 1.1 | 6104 | 1.1 | 6465 | 1.1 | 69750 | 1.1 | 7-219 | 1.2 |
| 4918 | 1.1 | 5140 | 1.1 | 53559 | 1.1 | 6104 | 1.1 | 6466 | 1.1 | 69751 | 1.1 | 7-219 | 1.2 |
| 4919 | 1.1 | 5141 | 1.1 | 53560 | 1.1 | 6104 | 1.1 | 6467 | 1.1 | 69752 | 1.1 | 7-219 | 1.2 |
| 4920 | 1.1 | 5142 | 1.1 | 53561 | 1.1 | 6104 | 1.1 | 6468 | 1.1 | 69753 | 1.1 | 7-219 | 1.2 |
| 4921 | 1.1 | 5143 | 1.1 | 53562 | 1.1 | 6104 | 1.1 | 6469 | 1.1 | 69754 | 1.1 | 7-219 | 1.2 |
| 4922 | 1.1 | 5144 | 1.1 | 53563 | 1.1 | 6104 | 1.1 | 6470 | 1.1 | 69755 | 1.1 | 7-219 | 1.2 |
| 4923 | 1.1 | 5145 | 1.1 | 53564 | 1.1 | 6104 | 1.1 | 6471 | 1.1 | 69756 | 1.1 | 7-219 | 1.2 |
| 4924 | 1.1 | 5146 | 1.1 | 53565 | 1.1 | 6104 | 1.1 | 6472 | 1.1 | 69757 | 1.1 | 7-219 | 1.2 |
| 4925 | 1.1 | 5147 | 1.1 | 53566 | 1.1 | 6104 | 1.1 | 6473 | 1.1 | 69758 | 1.1 | 7-219 | 1.2 |
| 4926 | 1.1 | 5148 | 1.1 | 53567 | 1.1 | 6104 | 1.1 | 6474 | 1.1 | 69759 | 1.1 | 7-219 | 1.2 |
| 4927 | 1.1 | 5149 | 1.1 | 53568 | 1.1 | 6104 | 1.1 | 6475 | 1.1 | 69760 | 1.1 | 7-219 | 1.2 |
| 4928 | 1.1 | 5150 | 1.1 | 53569 | 1.1 | 6104 | 1.1 | 6476 | 1.1 | 69761 | 1.1 | 7-219 | 1.2 |
| 4929 | 1.1 | 5151 | 1.1 | 53570 | 1.1 | 6104 | 1.1 | 6477 | 1.1 | 69762 | 1.1 | 7-219 | 1.2 |
| 4930 | 1.1 | 5152 | 1.1 | 53571 | 1.1 | 6104 | 1.1 | 6478 | 1.1 | 69763 | 1.1 | 7-219 | 1.2 |
| 4931 | 1.1 | 5153 | 1.1 | 53572 | 1.1 | 6104 | 1.1 | 6479 | 1.1 | 69764 | 1.1 | 7-219 | 1.2 |
| 4932 | 1.1 | 5154 | 1.1 | 53573 | 1.1 | 6104 | 1.1 | 6480 | 1.1 | 69765 | 1.1 | 7-219 | 1.2 |
| 4933 | 1.1 | 5155 | 1.1 | 53574 | 1.1 | 6104 | 1.1 | 6481 | 1.1 | 69766 | 1.1 | 7-219 | 1.2 |
| 4934 | 1.1 | 5156 | 1.1 | 53575 | 1.1 | 6104 | 1.1 | 6482 | 1.1 | 69767 | 1.1 | 7-219 | 1.2 |
| 4935 | 1.1 | 5157 | 1.1 | 53576 | 1.1 | 6104 | 1.1 | 6483 | 1.1 | 69768 | 1.1 | 7-219 | 1.2 |
| 4936 | 1.1 | 5158 | 1.1 | 53577 | 1.1 | 6104 | 1.1 | 6484 | 1.1 | 69769 | 1.1 | 7-219 | 1.2 |
| 4937 | 1.1 | 5159 | 1.1 | 53578 | 1.1 | 6104 | 1.1 | 6485 | 1.1 | 69770 | 1.1 | 7-219 | 1.2 |
| 4938 | 1.1 | 5160 | 1.1 | 53579 | 1.1 | 6104 | 1.1 | 6486 | 1.1 | 69771 | 1.1 | 7-219 | 1.2 |
| 4939 | 1.1 | 5161 | 1.1 | 53580 | 1.1 | 6104 | 1.1 | 6487 | 1.1 | 69772 | 1.1 | 7-219 | 1.2 |
| 4940 | 1.1 | 5162 | 1.1 | 53581 | 1.1 | 6104 | 1.1 | 6488 | 1.1 | 69773 | 1.1 | 7-219 | 1.2 |
| 4941 | 1.1 | 5163 | 1.1 | 53582 | 1.1 | 6104 | 1.1 | 6489 | 1.1 | 69774 | 1.1 | 7-219 | 1.2 |
| 4942 | 1.1 | 5164 | 1.1 | 53583 | 1.1 | 6104 | 1.1 | 6490 | 1.1 | 69775 | 1.1 | 7-219 | 1.2 |
| 4943 | 1.1 | 5165 | 1.1 | 53584 | 1.1 | 6104 | 1.1 | 6491 | 1.1 | 69776 | 1.1 | 7-219 | 1.2 |
| 4944 | 1.1 | 5166 | 1.1 | 53585 | 1.1 | 6104 | 1.1 | 6492 | 1.1 | 69777 | 1.1 | 7-219 | 1.2 |
| 4945 | 1.1 | 5167 | 1.1 | 53586 | 1.1 | 6104 | 1.1 | 6493 | 1.1 | 69778 | 1.1 | 7-219 | 1.2 |
| 4946 | 1.1 | 5168 | 1.1 | 53587 | 1.1 | 6104 | 1.1 | 6494 | 1.1 | 69779 | 1.1 | 7-219 | 1.2 |
| 4947 | 1.1 | 5169 | 1.1 | 53588 | 1.1 | 6104 | 1.1 | 6495 | 1.1 | 69780 | 1.1 | 7-219 | 1.2 |
| 4948 | 1.1 | 5170 | 1.1 | 53589 | 1.1 | 6104 | 1.1 | 6496 | 1.1 | 69781 | 1.1 | 7-219 | 1.2 |
| 4949 | 1.1 | 5171 | 1.1 | 53590 | 1.1 | 6104 | 1.1 | 6497 | 1.1 | 69782 | 1.1 | 7-219 | 1.2 |
| 4950 | 1.1 | 5172 | 1.1 | 53591 | 1.1 | 6104 | 1.1 | 6498 | 1.1 | 69783 | 1.1 | 7-219 | 1.2 |
| 4951 | 1.1 | 5173 | 1.1 | 53592 | 1.1 | 6104 | 1.1 | 6499 | 1.1 | 69784 | 1.1 | 7-219 | 1.2 |
| 4952 | 1.1 | 5174 | 1.1 | 53593 | 1.1 | 6104 | 1.1 | 6500 | 1.1 | 69785 | 1.1 | 7-219 | 1.2 |
| 4953 | 1.1 | 5175 | 1.1 | 53594 | 1.1 | 6104 | 1.1 | 6501 | 1.1 | 69786 | 1.1 | 7-219 | 1.2 |
| 4954 | 1.1 | 5176 | 1.1 | 53595 | 1.1 | 6104 | 1.1 | 6502 | 1.1 | 69787 | 1.1 | 7-219 | 1.2 |
| 4955 | 1.1 | 5177 | 1.1 | 53596 | 1.1 | 6104 | 1.1 | 6503 | 1.1 | 69788 | 1.1 | 7-219 | 1.2 |
| 4956 | 1.1 | 517 | | | | | | | | | | | |

| | | | | | | | | | | | | | |
|----------|------|----------|------|-------|------|-------|------|-------|------|-------|------|--------|------|
| 7-4830L3 | 7-24 | 7-445 | 7-23 | 7087 | 7-22 | 7184 | 7-22 | 7187 | 7-22 | 7252 | 7-22 | 7394 | 7-22 |
| 7-4842 | 7-24 | 7-446 | 7-23 | 7050 | 7-21 | 7127 | 7-22 | 7192C | 7-22 | 7272 | 7-22 | 7388 | 7-22 |
| 7-4844 | 7-24 | 7-448 | 7-23 | 7050Q | 7-21 | 7114 | 7-22 | 7193 | 7-22 | 7251 | 7-22 | 7389 | 7-22 |
| 7-4845 | 7-24 | 7-4530 | 7-23 | 7052 | 7-21 | 7125 | 7-22 | 7194 | 7-22 | 7243C | 7-22 | 7390 | 7-22 |
| 7-4846 | 7-24 | 7-4530G | 7-23 | 7053Q | 7-21 | 7136 | 7-22 | 7195 | 7-22 | 7254 | 7-22 | 7391 | 7-22 |
| 7-4854 | 7-24 | 7-451 | 7-23 | 7054 | 7-21 | 7137 | 7-22 | 7196 | 7-22 | 7244C | 7-22 | 7402B | 7-22 |
| 7-4856 | 7-24 | 7-452 | 7-23 | 7055Q | 7-21 | 7148 | 7-22 | 7197 | 7-22 | 7255 | 7-22 | 7402BA | 7-22 |
| 7-48612 | 7-24 | 7-456 | 7-23 | 7057 | 7-21 | 7149 | 7-22 | 7198 | 7-22 | 7256C | 7-22 | 7402BB | 7-22 |
| 7-4862 | 7-24 | 7-4564 | 7-23 | 7057D | 7-21 | 7140 | 7-22 | 7199 | 7-22 | 7256 | 7-22 | 7424 | 7-22 |
| 7-4863 | 7-24 | 7-458 | 7-23 | 7061 | 7-21 | 7142 | 7-22 | 7200 | 7-22 | 7257 | 7-22 | 7425 | 7-22 |
| 7-48813 | 7-24 | 7-4610B | 7-24 | 7066 | 7-21 | 7147 | 7-22 | 7201C | 7-22 | 7258 | 7-22 | 7426 | 7-22 |
| 7-4884 | 7-24 | 7-4642 | 7-24 | 7067 | 7-21 | 7143 | 7-22 | 7204 | 7-22 | 7259 | 7-22 | 7427 | 7-22 |
| 7-4886 | 7-24 | 7-4644 | 7-24 | 7049 | 7-21 | 7148 | 7-22 | 7205 | 7-22 | 7260 | 7-22 | 7428 | 7-22 |
| 7-4888 | 7-24 | 7-4644 | 7-24 | 7090 | 7-21 | 7145 | 7-22 | 7205C | 7-22 | 7260C | 7-22 | 7429 | 7-22 |
| 7-4910B | 7-24 | 7-4654 | 7-24 | 7070 | 7-21 | 7146 | 7-22 | 7206 | 7-22 | 7261 | 7-22 | 7430 | 7-22 |
| 7-4922 | 7-24 | 7-4662 | 7-24 | 7070Q | 7-21 | 7147 | 7-22 | 7206A | 7-22 | 7261C | 7-22 | 7431A | 7-22 |
| 7-4941 | 7-24 | 7-4668 | 7-24 | 7073 | 7-21 | 7148 | 7-22 | 7207 | 7-22 | 7262 | 7-22 | 7431 | 7-22 |
| 7-4954 | 7-24 | 7-4669 | 7-24 | 7073Q | 7-21 | 7149 | 7-22 | 7207C | 7-22 | 7262C | 7-22 | 7432 | 7-22 |
| 7-4956 | 7-24 | 7-4669 | 7-24 | 7072 | 7-21 | 7150 | 7-22 | 7208 | 7-22 | 7263 | 7-22 | 7433 | 7-22 |
| 7-4961 | 7-24 | 7-4684 | 7-24 | 7072J | 7-21 | 7151 | 7-22 | 7208C | 7-22 | 7263C | 7-22 | 7434 | 7-22 |
| 7-4962 | 7-24 | 7-4686 | 7-24 | 7071 | 7-21 | 7152 | 7-22 | 7209 | 7-22 | 7264 | 7-22 | 7435 | 7-22 |
| 7-4964 | 7-24 | 7-4688 | 7-24 | 7071Q | 7-21 | 7153 | 7-22 | 7209C | 7-22 | 7264C | 7-22 | 7436 | 7-22 |
| 7-4984 | 7-24 | 7-465012 | 7-24 | 7074 | 7-21 | 7156 | 7-22 | 7210 | 7-22 | 7265 | 7-22 | 7437 | 7-22 |
| 7-4988 | 7-24 | 7-46504 | 7-24 | 7076Q | 7-21 | 7157 | 7-22 | 7210C | 7-22 | 7266 | 7-22 | 7438 | 7-22 |
| 7-50612 | 7-24 | 7-4610A | 7-24 | 7077 | 7-21 | 7158 | 7-22 | 7211 | 7-22 | 7267 | 7-22 | 7439 | 7-22 |
| 7-5066 | 7-24 | 7-461432 | 7-24 | 7077Q | 7-21 | 7167 | 7-22 | 7211C | 7-22 | 7267C | 7-22 | 7440 | 7-22 |
| 7-5068 | 7-24 | 7-4622 | 7-24 | 7078 | 7-21 | 7161 | 7-22 | 7212 | 7-22 | 7268 | 7-22 | 7441 | 7-22 |
| 7-50812 | 7-24 | 7-4642 | 7-24 | 7078Q | 7-21 | 7162C | 7-22 | 7212C | 7-22 | 7269 | 7-22 | 7442 | 7-22 |
| 7-5084 | 7-24 | 7-4644 | 7-24 | 7079 | 7-21 | 7163 | 7-22 | 7213 | 7-22 | 7270 | 7-22 | 7443 | 7-22 |
| 7-5086 | 7-24 | 7-4646 | 7-24 | 7079Q | 7-21 | 7164C | 7-22 | 7214 | 7-22 | 7270C | 7-22 | 7444 | 7-22 |
| 7-5088 | 7-24 | 7-4648 | 7-24 | 7081 | 7-21 | 7165 | 7-22 | 7215 | 7-22 | 7271 | 7-22 | 7445 | 7-22 |
| 7-512 | 7-24 | 7-4652 | 7-24 | 7081B | 7-21 | 7165C | 7-22 | 7216 | 7-22 | 7272 | 7-22 | 7446 | 7-22 |
| 7-518 | 7-24 | 7-4654 | 7-24 | 7082 | 7-21 | 7166 | 7-22 | 7216C | 7-22 | 7273 | 7-22 | 7447 | 7-22 |
| 7-5110 | 7-24 | 7-4657 | 7-24 | 7082Q | 7-21 | 7167C | 7-22 | 7217 | 7-22 | 7274 | 7-22 | 7448 | 7-22 |
| 7-514 | 7-24 | 7-4661 | 7-24 | 7085 | 7-21 | 7167 | 7-22 | 7218 | 7-22 | 7275 | 7-22 | 7449 | 7-22 |
| 7-515 | 7-24 | 7-4664 | 7-24 | 7086 | 7-21 | 7168 | 7-22 | 7218C | 7-22 | 7276 | 7-22 | 7450 | 7-22 |
| 7-518 | 7-24 | 7-4668 | 7-24 | 7087 | 7-21 | 7168C | 7-22 | 7219 | 7-22 | 7277 | 7-22 | 7451 | 7-22 |
| 7-519 | 7-24 | 7-4669 | 7-24 | 7101C | 7-21 | 7169 | 7-22 | 7219C | 7-22 | 7278 | 7-22 | 7452 | 7-22 |
| 7-522 | 7-24 | 7-4672 | 7-24 | 7103 | 7-21 | 7169 | 7-22 | 7220 | 7-22 | 7279 | 7-22 | 7453 | 7-22 |
| 7-524 | 7-24 | 7-4676 | 7-24 | 7103C | 7-21 | 7170C | 7-22 | 7220C | 7-22 | 7280 | 7-22 | 7454 | 7-22 |
| 7-525 | 7-24 | 7-4678 | 7-24 | 7103 | 7-21 | 7171 | 7-22 | 7221 | 7-22 | 7281 | 7-22 | 7455 | 7-22 |
| 7-526 | 7-24 | 7-4684 | 7-24 | 7103C | 7-21 | 7170C | 7-22 | 7222 | 7-22 | 7282 | 7-22 | 7456 | 7-22 |
| 7-527 | 7-24 | 7-4688 | 7-24 | 7104 | 7-21 | 7171 | 7-22 | 7223 | 7-22 | 7283 | 7-22 | 7457 | 7-22 |
| 7-528 | 7-24 | 7-4692 | 7-24 | 7104C | 7-21 | 7172 | 7-22 | 7224 | 7-22 | 7284 | 7-22 | 7458 | 7-22 |
| 7-529 | 7-24 | 7-4696 | 7-24 | 7105 | 7-21 | 7173 | 7-22 | 7225 | 7-22 | 7285 | 7-22 | 7459 | 7-22 |
| 7-530 | 7-24 | 7-4698 | 7-24 | 7105C | 7-21 | 7174 | 7-22 | 7226 | 7-22 | 7286 | 7-22 | 7460 | 7-22 |
| 7-531 | 7-24 | 7-4702 | 7-24 | 7106 | 7-21 | 7175 | 7-22 | 7227 | 7-22 | 7287 | 7-22 | 7461 | 7-22 |
| 7-532 | 7-24 | 7-4706 | 7-24 | 7106C | 7-21 | 7176C | 7-22 | 7228 | 7-22 | 7288 | 7-22 | 7462 | 7-22 |
| 7-533 | 7-24 | 7-4710 | 7-24 | 7107 | 7-21 | 7177 | 7-22 | 7229 | 7-22 | 7289 | 7-22 | 7463 | 7-22 |
| 7-534 | 7-24 | 7-4714 | 7-24 | 7107C | 7-21 | 7178C | 7-22 | 7230 | 7-22 | 7290 | 7-22 | 7464 | 7-22 |
| 7-535 | 7-24 | 7-4718 | 7-24 | 7108 | 7-21 | 7179 | 7-22 | 7231 | 7-22 | 7291 | 7-22 | 7465 | 7-22 |
| 7-536 | 7-24 | 7-4722 | 7-24 | 7108C | 7-21 | 7180C | 7-22 | 7232 | 7-22 | 7292 | 7-22 | 7466 | 7-22 |
| 7-537 | 7-24 | 7-4726 | 7-24 | 7109 | 7-21 | 7181 | 7-22 | 7233 | 7-22 | 7293 | 7-22 | 7467 | 7-22 |
| 7-538 | 7-24 | 7-4730 | 7-24 | 7109C | 7-21 | 7182C | 7-22 | 7234 | 7-22 | 7294 | 7-22 | 7468 | 7-22 |
| 7-539 | 7-24 | 7-4734 | 7-24 | 7110 | 7-21 | 7183 | 7-22 | 7235 | 7-22 | 7295 | 7-22 | 7469 | 7-22 |
| 7-540 | 7-24 | 7-4738 | 7-24 | 7110C | 7-21 | 7184C | 7-22 | 7236 | 7-22 | 7296 | 7-22 | 7470 | 7-22 |
| 7-541 | 7-24 | 7-4742 | 7-24 | 7111 | 7-21 | 7185 | 7-22 | 7237 | 7-22 | 7297 | 7-22 | 7471 | 7-22 |
| 7-542 | 7-24 | 7-4746 | 7-24 | 7111C | 7-21 | 7186C | 7-22 | 7238 | 7-22 | 7298 | 7-22 | 7472 | 7-22 |
| 7-543 | 7-24 | 7-4750 | 7-24 | 7112 | 7-21 | 7187 | 7-22 | 7239 | 7-22 | 7299 | 7-22 | 7473 | 7-22 |
| 7-544 | 7-24 | 7-4754 | 7-24 | 7112C | 7-21 | 7188C | 7-22 | 7240 | 7-22 | 7300 | 7-22 | 7474 | 7-22 |
| 7-545 | 7-24 | 7-4758 | 7-24 | 7113 | 7-21 | 7189 | 7-22 | 7241 | 7-22 | 7301 | 7-22 | 7475 | 7-22 |
| 7-546 | 7-24 | 7-4762 | 7-24 | 7113C | 7-21 | 7190C | 7-22 | 7242 | 7-22 | 7302 | 7-22 | 7476 | 7-22 |
| 7-547 | 7-24 | 7-4766 | 7-24 | 7114 | 7-21 | 7191 | 7-22 | 7243 | 7-22 | 7303 | 7-22 | 7477 | 7-22 |
| 7-548 | 7-24 | 7-4770 | 7-24 | 7114C | 7-21 | 7192C | 7-22 | 7244 | 7-22 | 7304 | 7-22 | 7478 | 7-22 |
| 7-549 | 7-24 | 7-4774 | 7-24 | 7115 | 7-21 | 7193 | 7-22 | 7245 | 7-22 | 7305 | 7-22 | 7479 | 7-22 |
| 7-550 | 7-24 | 7-4778 | 7-24 | 7115C | 7-21 | 7194C | 7-22 | 7246 | 7-22 | 7306 | 7-22 | 7480 | 7-22 |
| 7-551 | 7-24 | 7-4782 | 7-24 | 7116 | 7-21 | 7195 | 7-22 | 7247 | 7-22 | 7307 | 7-22 | 7481 | 7-22 |
| 7-552 | 7-24 | 7-4786 | 7-24 | 7116C | 7-21 | 7196C | 7-22 | 7248 | 7-22 | 7308 | 7-22 | 7482 | 7-22 |
| 7-553 | 7-24 | 7-4790 | 7-24 | 7117 | 7-21 | 7197 | 7-22 | 7249 | 7-22 | 7309 | 7-22 | 7483 | 7-22 |
| 7-554 | 7-24 | 7-4794 | 7-24 | 7117C | 7-21 | 7198C | 7-22 | 7250 | 7-22 | 7310 | 7-22 | 7484 | 7-22 |
| 7-555 | 7-24 | 7-4798 | 7-24 | 7118 | 7-21 | 7199 | 7-22 | 7251 | 7-22 | 7311 | 7-22 | 7485 | 7-22 |
| 7-556 | 7-24 | 7-4802 | 7-24 | 7118C | 7-21 | 7200C | 7-22 | 7252 | 7-22 | 7312 | 7-22 | 7486 | 7-22 |
| 7-557 | 7-24 | 7-4806 | 7-24 | 7119 | 7-21 | 7201 | 7-22 | 7253 | 7-22 | 7313 | 7-22 | 7487 | 7-22 |
| 7-558 | 7-24 | 7-4810 | 7-24 | 7119C | 7-21 | 7202C | 7-22 | 7254 | 7-22 | 7314 | 7-22 | 7488 | 7-22 |
| 7-559 | 7-24 | 7-4814 | 7-24 | 7120 | 7-21 | 7203 | 7-22 | 7255 | 7-22 | 7315 | 7-22 | 7489 | 7-22 |
| 7-560 | 7-24 | 7-4818 | 7-24 | 7120C | 7-21 | 7204C | 7-22 | 7256 | 7-22 | 7316 | 7-22 | 7490 | 7-22 |
| 7-561 | 7-24 | 7-4822 | 7-24 | 7121 | 7-21 | 7205 | 7-22 | 7257 | 7-22 | 7317 | 7-22 | 7491 | 7-22 |
| 7-562 | 7-24 | 7-4826 | 7-24 | 7121C | 7-21 | 7206C | 7-22 | 7258 | 7-22 | 7318 | 7-22 | 7492 | 7-22 |
| 7-563 | 7-24 | 7-4830 | 7-24 | 7122 | 7-21 | 7207 | 7-22 | 7259 | 7-22 | 7319 | 7-22 | 7493 | 7-22 |
| 7-564 | 7-24 | 7-4834 | 7-24 | 7122C | 7-21 | 7208C | 7-22 | 7260 | 7-22 | 7320 | 7-22 | 7494 | 7-22 |
| 7-565 | 7-24 | 7-4838 | 7-24 | 7123 | 7-21 | 7209 | 7-22 | 7261 | 7-22 | 7321 | 7-22 | 7495 | 7-22 |
| 7-566 | 7-24 | 7-4842 | 7-24 | 7123C | 7-21 | 7210C | 7-22 | 7262 | 7-22 | 7322 | 7-22 | 7496 | 7-22 |
| 7-567 | 7-24 | 7-4846 | 7-24 | 7124 | 7-21 | 7211 | 7-22 | 7263 | 7-22 | 7323 | 7-22 | 7497 | 7-22 |
| 7-568 | 7-24 | 7-4850 | 7-24 | 7124C | 7-21 | 7212C | 7-22 | 7264 | 7-22 | 7324 | 7-22 | 7498 | 7-22 |
| 7-569 | 7-24 | 7-4854 | 7-24 | 7125 | 7-21 | 7213 | 7-22 | 7265 | 7-22 | 7325 | 7-22 | 7499 | 7-22 |
| 7-570 | 7-24 | 7-4858 | 7-24 | 7125C | 7-21 | 7214C | 7-22 | 7266 | 7-22 | 7326 | 7-22 | 7500 | 7-22 |
| 7-571 | 7-24 | 7-4862 | 7-24 | 7126 | 7-21 | 7215 | 7-22 | 7267 | 7-22 | 7327 | 7-22 | 7501 | 7-22 |
| 7-572 | 7-24 | 7-4866 | 7-24 | 7126C | 7-21 | 7216C | 7-22 | 7268 | 7-22 | 7328 | 7-22 | 7502 | 7-22 |
| 7-573 | 7-24 | 7-4870 | 7-24 | 7127 | 7-21 | 7217 | 7-22 | 7269 | 7-22 | 7329 | 7-22 | 7503 | 7-22 |
| 7-574 | 7-24 | 7-4874 | 7-24 | 7127C | 7-21 | 7218C | 7-22 | 7270 | 7-22 | 7330 | 7-22 | | |

| | | | | | | | | | | | | | |
|-------|------|--------|-----|-------|-----|-------|------|-------|------|-------|------|--------|------|
| 7451 | K 11 | 75119H | 112 | 75100 | 101 | 7721 | K 16 | 7721C | K 21 | 7810 | K 21 | 7994 | G 11 |
| 7451C | K 11 | 75120 | 117 | 75106 | 102 | 7721E | K 21 | 7722 | K 21 | 7811 | K 21 | 8011 | 1 21 |
| 7452 | K 11 | 75121 | 112 | 75107 | 102 | 7722A | K 11 | 7722C | K 21 | 7812 | K 21 | 8012 | 1 21 |
| 7453 | K 14 | 75122 | 112 | 75108 | 102 | 7722E | 1 21 | 7723 | K 16 | 7813 | K 21 | 8013AM | 1 21 |
| 7454 | K 14 | 75123 | 111 | 75109 | 102 | 7723 | K 11 | 7723C | K 21 | 7813C | K 21 | 8013 | 1 21 |
| 7455 | K 14 | 75124 | 111 | 75110 | 102 | 7723C | 1 11 | 7724 | K 16 | 7814 | K 21 | 8014 | 1 21 |
| 7456 | K 14 | 75125 | 111 | 75111 | 102 | 7724 | K 16 | 7724C | K 21 | 7815 | K 21 | 8015 | 1 21 |
| 7457 | K 14 | 75126 | 111 | 75112 | 102 | 7724E | K 21 | 7725 | K 16 | 7816 | K 21 | 8016 | 1 21 |
| 7458 | K 14 | 75127 | 111 | 75113 | 102 | 7725 | 1 11 | 7725C | K 21 | 7817 | K 21 | 8017 | 1 21 |
| 7459 | K 14 | 75128 | 110 | 75114 | 102 | 7725C | 1 11 | 7726 | K 16 | 7818 | K 21 | 8018 | 1 21 |
| 7460 | K 14 | 75129 | 110 | 75115 | 102 | 7726 | K 16 | 7726C | K 21 | 7819 | K 21 | 8019 | 1 21 |
| 7461 | K 14 | 75130 | 110 | 75116 | 102 | 7727 | K 16 | 7727C | K 21 | 7820 | K 21 | 8020 | 1 21 |
| 7462 | K 14 | 75131 | 110 | 75117 | 102 | 7727E | K 21 | 7728 | K 16 | 7821 | K 21 | 8021 | 1 21 |
| 7463 | K 14 | 75132 | 110 | 75118 | 102 | 7728 | K 16 | 7728C | K 21 | 7822 | K 21 | 8022 | 1 21 |
| 7464 | K 14 | 75133 | 110 | 75119 | 102 | 7728E | K 21 | 7729 | K 16 | 7823 | K 21 | 8023 | 1 21 |
| 7465 | K 14 | 75134 | 110 | 75120 | 102 | 7729 | K 16 | 7729C | K 21 | 7824 | K 21 | 8024 | 1 21 |
| 7466 | K 14 | 75135 | 110 | 75121 | 102 | 7729E | K 21 | 7730 | K 16 | 7825 | K 21 | 8025 | 1 21 |
| 7467 | K 14 | 75136 | 110 | 75122 | 102 | 7730 | K 16 | 7730C | K 21 | 7826 | K 21 | 8026 | 1 21 |
| 7468 | K 14 | 75137 | 110 | 75123 | 102 | 7730E | K 21 | 7731 | K 16 | 7827 | K 21 | 8027 | 1 21 |
| 7469 | K 14 | 75138 | 110 | 75124 | 102 | 7731 | K 16 | 7731C | K 21 | 7828 | K 21 | 8028 | 1 21 |
| 7470 | K 14 | 75139 | 110 | 75125 | 102 | 7731E | K 21 | 7732 | K 16 | 7829 | K 21 | 8029 | 1 21 |
| 7471 | K 14 | 75140 | 110 | 75126 | 102 | 7732 | K 16 | 7732C | K 21 | 7830 | K 21 | 8030 | 1 21 |
| 7472 | K 14 | 75141 | 110 | 75127 | 102 | 7732E | K 21 | 7733 | K 16 | 7831 | K 21 | 8031 | 1 21 |
| 7473 | K 14 | 75142 | 110 | 75128 | 102 | 7733 | K 16 | 7733C | K 21 | 7832 | K 21 | 8032 | 1 21 |
| 7474 | K 14 | 75143 | 110 | 75129 | 102 | 7733E | K 21 | 7734 | K 16 | 7833 | K 21 | 8033 | 1 21 |
| 7475 | K 14 | 75144 | 110 | 75130 | 102 | 7734 | K 16 | 7734C | K 21 | 7834 | K 21 | 8034 | 1 21 |
| 7476 | K 14 | 75145 | 110 | 75131 | 102 | 7734E | K 21 | 7735 | K 16 | 7835 | K 21 | 8035 | 1 21 |
| 7477 | K 14 | 75146 | 110 | 75132 | 102 | 7735 | K 16 | 7735C | K 21 | 7836 | K 21 | 8036 | 1 21 |
| 7478 | K 14 | 75147 | 110 | 75133 | 102 | 7735E | K 21 | 7736 | K 16 | 7837 | K 21 | 8037 | 1 21 |
| 7479 | K 14 | 75148 | 110 | 75134 | 102 | 7736 | K 16 | 7736C | K 21 | 7838 | K 21 | 8038 | 1 21 |
| 7480 | K 14 | 75149 | 110 | 75135 | 102 | 7736E | K 21 | 7737 | K 16 | 7839 | K 21 | 8039 | 1 21 |
| 7481 | K 14 | 75150 | 110 | 75136 | 102 | 7737 | K 16 | 7737C | K 21 | 7840 | K 21 | 8040 | 1 21 |
| 7482 | K 14 | 75151 | 110 | 75137 | 102 | 7737E | K 21 | 7738 | K 16 | 7841 | K 21 | 8041 | 1 21 |
| 7483 | K 14 | 75152 | 110 | 75138 | 102 | 7738 | K 16 | 7738C | K 21 | 7842 | K 21 | 8042 | 1 21 |
| 7484 | K 14 | 75153 | 110 | 75139 | 102 | 7738E | K 21 | 7739 | K 16 | 7843 | K 21 | 8043 | 1 21 |
| 7485 | K 14 | 75154 | 110 | 75140 | 102 | 7739 | K 16 | 7739C | K 21 | 7844 | K 21 | 8044 | 1 21 |
| 7486 | K 14 | 75155 | 110 | 75141 | 102 | 7739E | K 21 | 7740 | K 16 | 7845 | K 21 | 8045 | 1 21 |
| 7487 | K 14 | 75156 | 110 | 75142 | 102 | 7740 | K 16 | 7740C | K 21 | 7846 | K 21 | 8046 | 1 21 |
| 7488 | K 14 | 75157 | 110 | 75143 | 102 | 7740E | K 21 | 7741 | K 16 | 7847 | K 21 | 8047 | 1 21 |
| 7489 | K 14 | 75158 | 110 | 75144 | 102 | 7741 | K 16 | 7741C | K 21 | 7848 | K 21 | 8048 | 1 21 |
| 7490 | K 14 | 75159 | 110 | 75145 | 102 | 7741E | K 21 | 7742 | K 16 | 7849 | K 21 | 8049 | 1 21 |
| 7491 | K 14 | 75160 | 110 | 75146 | 102 | 7742 | K 16 | 7742C | K 21 | 7850 | K 21 | 8050 | 1 21 |
| 7492 | K 14 | 75161 | 110 | 75147 | 102 | 7742E | K 21 | 7743 | K 16 | 7851 | K 21 | 8051 | 1 21 |
| 7493 | K 14 | 75162 | 110 | 75148 | 102 | 7743 | K 16 | 7743C | K 21 | 7852 | K 21 | 8052 | 1 21 |
| 7494 | K 14 | 75163 | 110 | 75149 | 102 | 7743E | K 21 | 7744 | K 16 | 7853 | K 21 | 8053 | 1 21 |
| 7495 | K 14 | 75164 | 110 | 75150 | 102 | 7744 | K 16 | 7744C | K 21 | 7854 | K 21 | 8054 | 1 21 |
| 7496 | K 14 | 75165 | 110 | 75151 | 102 | 7744E | K 21 | 7745 | K 16 | 7855 | K 21 | 8055 | 1 21 |
| 7497 | K 14 | 75166 | 110 | 75152 | 102 | 7745 | K 16 | 7745C | K 21 | 7856 | K 21 | 8056 | 1 21 |
| 7498 | K 14 | 75167 | 110 | 75153 | 102 | 7745E | K 21 | 7746 | K 16 | 7857 | K 21 | 8057 | 1 21 |
| 7499 | K 14 | 75168 | 110 | 75154 | 102 | 7746 | K 16 | 7746C | K 21 | 7858 | K 21 | 8058 | 1 21 |
| 7500 | K 14 | 75169 | 110 | 75155 | 102 | 7746E | K 21 | 7747 | K 16 | 7859 | K 21 | 8059 | 1 21 |
| 7501 | K 14 | 75170 | 110 | 75156 | 102 | 7747 | K 16 | 7747C | K 21 | 7860 | K 21 | 8060 | 1 21 |
| 7502 | K 14 | 75171 | 110 | 75157 | 102 | 7747E | K 21 | 7748 | K 16 | 7861 | K 21 | 8061 | 1 21 |
| 7503 | K 14 | 75172 | 110 | 75158 | 102 | 7748 | K 16 | 7748C | K 21 | 7862 | K 21 | 8062 | 1 21 |
| 7504 | K 14 | 75173 | 110 | 75159 | 102 | 7748E | K 21 | 7749 | K 16 | 7863 | K 21 | 8063 | 1 21 |
| 7505 | K 14 | 75174 | 110 | 75160 | 102 | 7749 | K 16 | 7749C | K 21 | 7864 | K 21 | 8064 | 1 21 |
| 7506 | K 14 | 75175 | 110 | 75161 | 102 | 7749E | K 21 | 7750 | K 16 | 7865 | K 21 | 8065 | 1 21 |
| 7507 | K 14 | 75176 | 110 | 75162 | 102 | 7750 | K 16 | 7750C | K 21 | 7866 | K 21 | 8066 | 1 21 |
| 7508 | K 14 | 75177 | 110 | 75163 | 102 | 7750E | K 21 | 7751 | K 16 | 7867 | K 21 | 8067 | 1 21 |
| 7509 | K 14 | 75178 | 110 | 75164 | 102 | 7751 | K 16 | 7751C | K 21 | 7868 | K 21 | 8068 | 1 21 |
| 7510 | K 14 | 75179 | 110 | 75165 | 102 | 7751E | K 21 | 7752 | K 16 | 7869 | K 21 | 8069 | 1 21 |
| 7511 | K 14 | 75180 | 110 | 75166 | 102 | 7752 | K 16 | 7752C | K 21 | 7870 | K 21 | 8070 | 1 21 |
| 7512 | K 14 | 75181 | 110 | 75167 | 102 | 7752E | K 21 | 7753 | K 16 | 7871 | K 21 | 8071 | 1 21 |
| 7513 | K 14 | 75182 | 110 | 75168 | 102 | 7753 | K 16 | 7753C | K 21 | 7872 | K 21 | 8072 | 1 21 |
| 7514 | K 14 | 75183 | 110 | 75169 | 102 | 7753E | K 21 | 7754 | K 16 | 7873 | K 21 | 8073 | 1 21 |
| 7515 | K 14 | 75184 | 110 | 75170 | 102 | 7754 | K 16 | 7754C | K 21 | 7874 | K 21 | 8074 | 1 21 |
| 7516 | K 14 | 75185 | 110 | 75171 | 102 | 7754E | K 21 | 7755 | K 16 | 7875 | K 21 | 8075 | 1 21 |
| 7517 | K 14 | 75186 | 110 | 75172 | 102 | 7755 | K 16 | 7755C | K 21 | 7876 | K 21 | 8076 | 1 21 |
| 7518 | K 14 | 75187 | 110 | 75173 | 102 | 7755E | K 21 | 7756 | K 16 | 7877 | K 21 | 8077 | 1 21 |
| 7519 | K 14 | 75188 | 110 | 75174 | 102 | 7756 | K 16 | 7756C | K 21 | 7878 | K 21 | 8078 | 1 21 |
| 7520 | K 14 | 75189 | 110 | 75175 | 102 | 7756E | K 21 | 7757 | K 16 | 7879 | K 21 | 8079 | 1 21 |
| 7521 | K 14 | 75190 | 110 | 75176 | 102 | 7757 | K 16 | 7757C | K 21 | 7880 | K 21 | 8080 | 1 21 |
| 7522 | K 14 | 75191 | 110 | 75177 | 102 | 7757E | K 21 | 7758 | K 16 | 7881 | K 21 | 8081 | 1 21 |
| 7523 | K 14 | 75192 | 110 | 75178 | 102 | 7758 | K 16 | 7758C | K 21 | 7882 | K 21 | 8082 | 1 21 |
| 7524 | K 14 | 75193 | 110 | 75179 | 102 | 7758E | K 21 | 7759 | K 16 | 7883 | K 21 | 8083 | 1 21 |
| 7525 | K 14 | 75194 | 110 | 75180 | 102 | 7759 | K 16 | 7759C | K 21 | 7884 | K 21 | 8084 | 1 21 |
| 7526 | K 14 | 75195 | 110 | 75181 | 102 | 7759E | K 21 | 7760 | K 16 | 7885 | K 21 | 8085 | 1 21 |
| 7527 | K 14 | 75196 | 110 | 75182 | 102 | 7760 | K 16 | 7760C | K 21 | 7886 | K 21 | 8086 | 1 21 |
| 7528 | K 14 | 75197 | 110 | 75183 | 102 | 7760E | K 21 | 7761 | K 16 | 7887 | K 21 | 8087 | 1 21 |
| 7529 | K 14 | 75198 | 110 | 75184 | 102 | 7761 | K 16 | 7761C | K 21 | 7888 | K 21 | 8088 | 1 21 |
| 7530 | K 14 | 75199 | 110 | 75185 | 102 | 7761E | K 21 | 7762 | K 16 | 7889 | K 21 | 8089 | 1 21 |
| 7531 | K 14 | 75200 | 110 | 75186 | 102 | 7762 | K 16 | 7762C | K 21 | 7890 | K 21 | 8090 | 1 21 |
| 7532 | K 14 | 75201 | 110 | 75187 | 102 | 7762E | K 21 | 7763 | K 16 | 7891 | K 21 | 8091 | 1 21 |
| 7533 | K 14 | 75202 | 110 | 75188 | 102 | 7763 | K 16 | 7763C | K 21 | 7892 | K 21 | 8092 | 1 21 |
| 7534 | K 14 | 75203 | 110 | 75189 | 102 | 7763E | K 21 | 7764 | K 16 | 7893 | K 21 | 8093 | 1 21 |
| 7535 | K 14 | 75204 | 110 | 75190 | 102 | 7764 | K 16 | 7764C | K 21 | 7894 | K 21 | 8094 | 1 21 |
| 7536 | K 14 | 75205 | 110 | 75191 | 102 | 7764E | K 21 | 7765 | K 16 | 7895 | K 21 | 8095 | 1 21 |
| 7537 | K 14 | 75206 | 110 | 75192 | 102 | 7765 | K 16 | 7765C | K 21 | 7896 | K 21 | 8096 | 1 21 |
| 7538 | K 14 | 75207 | 110 | 75193 | 102 | 7765E | K 21 | 7766 | K 16 | 7897 | K 21 | 8097 | 1 21 |
| 7539 | K 14 | 75208 | 110 | 75194 | 102 | 7766 | K 16 | 7766C | K 21 | 7898 | K 21 | 8098 | 1 21 |
| 7540 | K 14 | 75209 | 110 | 75195 | 102 | 7766E | K 21 | 7767 | K 16 | 7899 | K 21 | 8099 | 1 21 |
| 7541 | K 14 | 75210 | 110 | 75196 | 102 | 7767 | K 16 | 7767C | K 21 | 7900 | K 21 | 8100 | 1 21 |
| 7542 | K 14 | 75211 | 110 | 75197 | 102 | 7767E | K 21 | 7768 | K 16 | 7901 | K 21 | 8101 | 1 21 |
| 7543 | K 14 | 75212 | 110 | 75198 | 102 | 7768 | K 16 | 7768C | K 21 | 7902 | K 21 | 8102 | 1 21 |
| 7544 | K 14 | 75213 | 110 | 75199 | 102 | 7768E | K 21 | 7769 | K 16 | 7903 | K 21 | 8103 | 1 21 |
| 7545 | K 14 | 75214 | 110 | 75200 | 102 | 7769 | K 16 | 7769C | K 21 | | | | |

INDEX : PART# TO PAGE#

| Part # | Page | Part # | Page | Part # | Page | Part # | Page | Part # | Page | Part # | Page | Part # | Page |
|--------|------|--------|------|--------|------|--------|------|--------|------|--------|------|------------|------|
| 804910 | 22 | 8121 | 22 | 855 | 22 | 87479 | 22 | 8802 | 22 | 888 | 22 | 894858 | 22 |
| 806943 | 22 | 8177 | 22 | 8691 | 22 | 8730 | 22 | 883 | 22 | 890 | 22 | 8941941000 | 22 |
| 808954 | 22 | 8176 | 22 | 8697 | 22 | 874 | 22 | 88100 | 22 | 891 | 22 | 895114330 | 22 |
| 809915 | 22 | 818 | 22 | 8698 | 22 | 8740 | 22 | 88201 | 22 | 89102 | 22 | 89512555 | 22 |
| 809920 | 22 | 8180 | 22 | 8699 | 22 | 875 | 22 | 88205 | 22 | 89103 | 22 | 895126750 | 22 |
| 809934 | 22 | 8181 | 22 | 870 | 22 | 8750 | 22 | 88206 | 22 | 89104 | 22 | 89512700 | 22 |
| 809937 | 22 | 8182 | 22 | 8700 | 22 | 8751 | 22 | 88207 | 22 | 89105 | 22 | 89512800 | 22 |
| 809938 | 22 | 8183 | 22 | 8701 | 22 | 8752 | 22 | 88208 | 22 | 89106 | 22 | 89512900 | 22 |
| 809939 | 22 | 8184 | 22 | 8702 | 22 | 8753 | 22 | 88209 | 22 | 89107 | 22 | 89513000 | 22 |
| 809940 | 22 | 8185 | 22 | 8703 | 22 | 8754 | 22 | 88210 | 22 | 89108 | 22 | 89513100 | 22 |
| 809941 | 22 | 8186 | 22 | 8704 | 22 | 8755 | 22 | 88211 | 22 | 89109 | 22 | 89513200 | 22 |
| 809942 | 22 | 8187 | 22 | 8705 | 22 | 8756 | 22 | 88212 | 22 | 89110 | 22 | 89513300 | 22 |
| 809943 | 22 | 8188 | 22 | 8706 | 22 | 8757 | 22 | 88213 | 22 | 89111 | 22 | 89513400 | 22 |
| 809944 | 22 | 8189 | 22 | 8707 | 22 | 8758 | 22 | 88214 | 22 | 89112 | 22 | 89513500 | 22 |
| 809945 | 22 | 8190 | 22 | 8708 | 22 | 8759 | 22 | 88215 | 22 | 89113 | 22 | 89513600 | 22 |
| 809946 | 22 | 8191 | 22 | 8709 | 22 | 8760 | 22 | 88216 | 22 | 89114 | 22 | 89513700 | 22 |
| 809947 | 22 | 8192 | 22 | 8710 | 22 | 8761 | 22 | 88217 | 22 | 89115 | 22 | 89513800 | 22 |
| 809948 | 22 | 8193 | 22 | 8711 | 22 | 8762 | 22 | 88218 | 22 | 89116 | 22 | 89513900 | 22 |
| 809949 | 22 | 8194 | 22 | 8712 | 22 | 8763 | 22 | 88219 | 22 | 89117 | 22 | 89514000 | 22 |
| 809950 | 22 | 8195 | 22 | 8713 | 22 | 8764 | 22 | 88220 | 22 | 89118 | 22 | 89514100 | 22 |
| 809951 | 22 | 8196 | 22 | 8714 | 22 | 8765 | 22 | 88221 | 22 | 89119 | 22 | 89514200 | 22 |
| 809952 | 22 | 8197 | 22 | 8715 | 22 | 8766 | 22 | 88222 | 22 | 89120 | 22 | 89514300 | 22 |
| 809953 | 22 | 8198 | 22 | 8716 | 22 | 8767 | 22 | 88223 | 22 | 89121 | 22 | 89514400 | 22 |
| 809954 | 22 | 8199 | 22 | 8717 | 22 | 8768 | 22 | 88224 | 22 | 89122 | 22 | 89514500 | 22 |
| 809955 | 22 | 8200 | 22 | 8718 | 22 | 8769 | 22 | 88225 | 22 | 89123 | 22 | 89514600 | 22 |
| 809956 | 22 | 8201 | 22 | 8719 | 22 | 8770 | 22 | 88226 | 22 | 89124 | 22 | 89514700 | 22 |
| 809957 | 22 | 8202 | 22 | 8720 | 22 | 8771 | 22 | 88227 | 22 | 89125 | 22 | 89514800 | 22 |
| 809958 | 22 | 8203 | 22 | 8721 | 22 | 8772 | 22 | 88228 | 22 | 89126 | 22 | 89514900 | 22 |
| 809959 | 22 | 8204 | 22 | 8722 | 22 | 8773 | 22 | 88229 | 22 | 89127 | 22 | 89515000 | 22 |
| 809960 | 22 | 8205 | 22 | 8723 | 22 | 8774 | 22 | 88230 | 22 | 89128 | 22 | 89515100 | 22 |
| 809961 | 22 | 8206 | 22 | 8724 | 22 | 8775 | 22 | 88231 | 22 | 89129 | 22 | 89515200 | 22 |
| 809962 | 22 | 8207 | 22 | 8725 | 22 | 8776 | 22 | 88232 | 22 | 89130 | 22 | 89515300 | 22 |
| 809963 | 22 | 8208 | 22 | 8726 | 22 | 8777 | 22 | 88233 | 22 | 89131 | 22 | 89515400 | 22 |
| 809964 | 22 | 8209 | 22 | 8727 | 22 | 8778 | 22 | 88234 | 22 | 89132 | 22 | 89515500 | 22 |
| 809965 | 22 | 8210 | 22 | 8728 | 22 | 8779 | 22 | 88235 | 22 | 89133 | 22 | 89515600 | 22 |
| 809966 | 22 | 8211 | 22 | 8729 | 22 | 8780 | 22 | 88236 | 22 | 89134 | 22 | 89515700 | 22 |
| 809967 | 22 | 8212 | 22 | 8730 | 22 | 8781 | 22 | 88237 | 22 | 89135 | 22 | 89515800 | 22 |
| 809968 | 22 | 8213 | 22 | 8731 | 22 | 8782 | 22 | 88238 | 22 | 89136 | 22 | 89515900 | 22 |
| 809969 | 22 | 8214 | 22 | 8732 | 22 | 8783 | 22 | 88239 | 22 | 89137 | 22 | 89516000 | 22 |
| 809970 | 22 | 8215 | 22 | 8733 | 22 | 8784 | 22 | 88240 | 22 | 89138 | 22 | 89516100 | 22 |
| 809971 | 22 | 8216 | 22 | 8734 | 22 | 8785 | 22 | 88241 | 22 | 89139 | 22 | 89516200 | 22 |
| 809972 | 22 | 8217 | 22 | 8735 | 22 | 8786 | 22 | 88242 | 22 | 89140 | 22 | 89516300 | 22 |
| 809973 | 22 | 8218 | 22 | 8736 | 22 | 8787 | 22 | 88243 | 22 | 89141 | 22 | 89516400 | 22 |
| 809974 | 22 | 8219 | 22 | 8737 | 22 | 8788 | 22 | 88244 | 22 | 89142 | 22 | 89516500 | 22 |
| 809975 | 22 | 8220 | 22 | 8738 | 22 | 8789 | 22 | 88245 | 22 | 89143 | 22 | 89516600 | 22 |
| 809976 | 22 | 8221 | 22 | 8739 | 22 | 8790 | 22 | 88246 | 22 | 89144 | 22 | 89516700 | 22 |
| 809977 | 22 | 8222 | 22 | 8740 | 22 | 8791 | 22 | 88247 | 22 | 89145 | 22 | 89516800 | 22 |
| 809978 | 22 | 8223 | 22 | 8741 | 22 | 8792 | 22 | 88248 | 22 | 89146 | 22 | 89516900 | 22 |
| 809979 | 22 | 8224 | 22 | 8742 | 22 | 8793 | 22 | 88249 | 22 | 89147 | 22 | 89517000 | 22 |
| 809980 | 22 | 8225 | 22 | 8743 | 22 | 8794 | 22 | 88250 | 22 | 89148 | 22 | 89517100 | 22 |
| 809981 | 22 | 8226 | 22 | 8744 | 22 | 8795 | 22 | 88251 | 22 | 89149 | 22 | 89517200 | 22 |
| 809982 | 22 | 8227 | 22 | 8745 | 22 | 8796 | 22 | 88252 | 22 | 89150 | 22 | 89517300 | 22 |
| 809983 | 22 | 8228 | 22 | 8746 | 22 | 8797 | 22 | 88253 | 22 | 89151 | 22 | 89517400 | 22 |
| 809984 | 22 | 8229 | 22 | 8747 | 22 | 8798 | 22 | 88254 | 22 | 89152 | 22 | 89517500 | 22 |
| 809985 | 22 | 8230 | 22 | 8748 | 22 | 8799 | 22 | 88255 | 22 | 89153 | 22 | 89517600 | 22 |
| 809986 | 22 | 8231 | 22 | 8749 | 22 | 8800 | 22 | 88256 | 22 | 89154 | 22 | 89517700 | 22 |
| 809987 | 22 | 8232 | 22 | 8750 | 22 | 8801 | 22 | 88257 | 22 | 89155 | 22 | 89517800 | 22 |
| 809988 | 22 | 8233 | 22 | 8751 | 22 | 8802 | 22 | 88258 | 22 | 89156 | 22 | 89517900 | 22 |
| 809989 | 22 | 8234 | 22 | 8752 | 22 | 8803 | 22 | 88259 | 22 | 89157 | 22 | 89518000 | 22 |
| 809990 | 22 | 8235 | 22 | 8753 | 22 | 8804 | 22 | 88260 | 22 | 89158 | 22 | 89518100 | 22 |
| 809991 | 22 | 8236 | 22 | 8754 | 22 | 8805 | 22 | 88261 | 22 | 89159 | 22 | 89518200 | 22 |
| 809992 | 22 | 8237 | 22 | 8755 | 22 | 8806 | 22 | 88262 | 22 | 89160 | 22 | 89518300 | 22 |
| 809993 | 22 | 8238 | 22 | 8756 | 22 | 8807 | 22 | 88263 | 22 | 89161 | 22 | 89518400 | 22 |
| 809994 | 22 | 8239 | 22 | 8757 | 22 | 8808 | 22 | 88264 | 22 | 89162 | 22 | 89518500 | 22 |
| 809995 | 22 | 8240 | 22 | 8758 | 22 | 8809 | 22 | 88265 | 22 | 89163 | 22 | 89518600 | 22 |
| 809996 | 22 | 8241 | 22 | 8759 | 22 | 8810 | 22 | 88266 | 22 | 89164 | 22 | 89518700 | 22 |
| 809997 | 22 | 8242 | 22 | 8760 | 22 | 8811 | 22 | 88267 | 22 | 89165 | 22 | 89518800 | 22 |
| 809998 | 22 | 8243 | 22 | 8761 | 22 | 8812 | 22 | 88268 | 22 | 89166 | 22 | 89518900 | 22 |
| 809999 | 22 | 8244 | 22 | 8762 | 22 | 8813 | 22 | 88269 | 22 | 89167 | 22 | 89519000 | 22 |
| 810000 | 22 | 8245 | 22 | 8763 | 22 | 8814 | 22 | 88270 | 22 | 89168 | 22 | 89519100 | 22 |
| 810001 | 22 | 8246 | 22 | 8764 | 22 | 8815 | 22 | 88271 | 22 | 89169 | 22 | 89519200 | 22 |
| 810002 | 22 | 8247 | 22 | 8765 | 22 | 8816 | 22 | 88272 | 22 | 89170 | 22 | 89519300 | 22 |
| 810003 | 22 | 8248 | 22 | 8766 | 22 | 8817 | 22 | 88273 | 22 | 89171 | 22 | 89519400 | 22 |
| 810004 | 22 | 8249 | 22 | 8767 | 22 | 8818 | 22 | 88274 | 22 | 89172 | 22 | 89519500 | 22 |
| 810005 | 22 | 8250 | 22 | 8768 | 22 | 8819 | 22 | 88275 | 22 | 89173 | 22 | 89519600 | 22 |
| 810006 | 22 | 8251 | 22 | 8769 | 22 | 8820 | 22 | 88276 | 22 | 89174 | 22 | 89519700 | 22 |
| 810007 | 22 | 8252 | 22 | 8770 | 22 | 8821 | 22 | 88277 | 22 | 89175 | 22 | 89519800 | 22 |
| 810008 | 22 | 8253 | 22 | 8771 | 22 | 8822 | 22 | 88278 | 22 | 89176 | 22 | 89519900 | 22 |
| 810009 | 22 | 8254 | 22 | 8772 | 22 | 8823 | 22 | 88279 | 22 | 89177 | 22 | 89520000 | 22 |
| 810010 | 22 | 8255 | 22 | 8773 | 22 | 8824 | 22 | 88280 | 22 | 89178 | 22 | 89520100 | 22 |
| 810011 | 22 | 8256 | 22 | 8774 | 22 | 8825 | 22 | 88281 | 22 | 89179 | 22 | 89520200 | 22 |
| 810012 | 22 | 8257 | 22 | 8775 | 22 | 8826 | 22 | 88282 | 22 | 89180 | 22 | 89520300 | 22 |
| 810013 | 22 | 8258 | 22 | 8776 | 22 | 8827 | 22 | 88283 | 22 | 89181 | 22 | 89520400 | 22 |
| 810014 | 22 | 8259 | 22 | 8777 | 22 | 8828 | 22 | 88284 | 22 | 89182 | 22 | 89520500 | 22 |
| 810015 | 22 | 8260 | 22 | 8778 | 22 | 8829 | 22 | 88285 | 22 | 89183 | 22 | 89520600 | 22 |
| 810016 | 22 | 8261 | 22 | 8779 | 22 | 8830 | 22 | 88286 | 22 | 89184 | 22 | 89520700 | 22 |
| 810017 | 22 | 8262 | 22 | 8780 | 22 | 8831 | 22 | 88287 | 22 | 89185 | 22 | 89520800 | 22 |
| 810018 | 22 | 8263 | 22 | 8781 | 22 | 8832 | 22 | 88288 | 22 | 89186 | 22 | 89520900 | 22 |
| 810019 | 22 | 8264 | 22 | 8782 | 22 | 8833 | 22 | 88289 | 22 | 89187 | 22 | 89521000 | 22 |
| 810020 | 22 | 8265 | 22 | 8783 | 22 | 8834 | 22 | 88290 | 22 | 89188 | 22 | 89521100 | 22 |
| 810021 | 22 | 8266 | 22 | 8784 | 22 | 8835 | 22 | 88291 | 22 | 89189 | 22 | 89521200 | 22 |
| 810022 | 22 | 8267 | 22 | 8785 | 22 | 8836 | 22 | 88292 | 22 | 89190 | 22 | 89521300 | 22 |
| 810023 | 22 | 8268 | 22 | 8786 | 22 | 8837 | 22 | 88293 | 22 | 89191 | 22 | 89521400 | 22 |
| 810024 | 22 | 8269 | 22 | 8787 | 22 | 8838 | 22 | 88294 | 22 | 89192 | 22 | 89521500 | 22 |
| 810025 | 22 | 8270 | 22 | 8788 | 22 | 8839 | 22 | 88295 | 22 | 89193 | 22 | 89521600 | 22 |
| 810026 | 22 | 8271 | 22 | 8789 | 22 | 8840 | 22 | 88296 | 22 | 89194 | 22 | 89521700 | 22 |
| 810027 | 22 | 8272 | 22 | 8790 | 22 | 8841 | 22 | 88297 | 22 | 89195 | 22 | | |

| | | | | | |
|---------|-------------|---------|----------|-------|--------|
| BT07100 | BT6050 | L1215 | LS6015 | LT125 | MP206 |
| BT03110 | BT6000 | L1251 | LS6027 | LT200 | MP208 |
| BT03400 | BT6040 | L1267 | LS81 | LT210 | MP210 |
| BT04000 | BT6060 | L1281 | LS800P | LT256 | MP212 |
| BT04400 | BT6110 | L1248 | LS800HL | LT311 | MP215 |
| BT04600 | BT6150T | L1260C | LS81 | LT312 | MP218 |
| BT06600 | BT6200 | L1260D | LS100H | LT317 | MP224 |
| BT06700 | BT6200 | L1251 | LS100PC | LT318 | MP200C |
| BT08000 | BT6200 | L1261 | LS140 | LT319 | MP2004 |
| BT08044 | BT6211 | L1161 | LS140C | LT320 | MP2004 |
| BT08060 | BT62150 | L1121 | LS140C2 | LT321 | MP2010 |
| BT08067 | BT6220 | L1181 | LS160A11 | LT322 | MP2010 |
| BT08061 | BT6230 | L1151 | LS160K | LT323 | MP2010 |
| BT08064 | BT6230 | L12000G | LS160R6 | LT324 | MP2012 |
| L112 | BT6230H | L2001 | LS160R0 | LT325 | MP2016 |
| L132 | BT62414 | L1201 | L202H | LT326 | MP204 |
| C149 | BT62170 | L21010 | LS200C | LT327 | MP2018 |
| C170 | BT6260 | L21011 | LS200C2 | LT328 | MP210L |
| C412 | BT6272 | L21012 | LS21 | LT329 | MP20K |
| C416 | BT6280 | L21013 | LS200P | LT330 | MP210 |
| C418 | BT6280A | L21015 | LS200R0 | LT331 | MP2110 |
| C480 | BT6400C | L21021 | LS21 | LT332 | MP2110 |
| C487 | BT6400L | L23023 | LS200K | LT333 | MP2114 |
| C480 | BT6400 | L234 | LS200K | LT334 | MP2117 |
| C486 | BT620AL | L218 | LS200HL | LT335 | MP215 |
| C518 | BT6200 | L211 | LS200R0 | LT336 | MP21A |
| C604 | BT6183 | L220 | LS21 | LT337 | MP2110 |
| C606 | BT6100 | L2211 | LS200C | LT338 | MP211A |
| C606 | BT6555C | L221 | LS21 | LT339 | MP211B |
| LR10 | BT6600 | L2107 | LS21 | LT340 | MP222 |
| LR12 | BT6081 | L211 | LS25 | LT341 | MP220K |
| LR08 | BT6087 | L2411 | LS24CT | LT342 | MP220K |
| CG13C | BT6081 | L241 | LS24 | LT343 | MP2104 |
| CG132 | BT6170 | L241 | LS200HC | LT344 | MP2104 |
| CG16 | BT6273 | L211L | LS2112 | LT345 | MP2104 |
| IAR100 | BT6210H | L20CT | LS2142 | LT346 | MP210K |
| LDW50 | BT60435501W | L20L | LS2104 | LT347 | MP2110 |
| ICL60M | BT60235502 | L20L | LS2105 | LT348 | MP2112 |
| PC1700 | BT60235501W | L105 | LS2107 | LT349 | MP2114 |
| PC1500P | GS610100P | L1141 | LS21 | LT350 | MP2114 |
| PC1500T | GS610100L | L1120 | LS200H | LT351 | MP2101 |
| PC150TC | GS620100D | L121 | LS100G | LT352 | MP2116 |
| PC1514 | GS610100L3 | L151 | LS100Q | LT353 | MP244K |
| PC1515 | GS61435501W | L160 | LS100H | LT354 | MP250R |
| IC2000 | GS61335501 | L1602H | LS100AC | LT355 | MP2510 |
| PC1250 | GS6103550P | L1610 | LS100R0 | LT356 | MP2512 |
| PC1250H | L1610 | L161 | LS100K | LT357 | MP2518 |
| PC1300 | L1611 | L111 | LS100HL | LT358 | MP2518 |
| PC1320 | L1613M | L181 | LS11 | LT359 | MP2518 |
| IC15150 | L161K | L2012 | LS20 | LT360 | MP240K |
| IC8000 | L2071 | L1005 | LS20H | LT361 | MP210 |
| IC8015 | L225L | L100L | LS20H | LT362 | MP2102 |
| PC0070 | L274 | L1140 | LS200G | LT363 | MP2110 |
| PC0010 | L282 | L2100D | LS200 | LT364 | MP2110 |
| PC1050 | L291L | L2141 | LS200C2 | LT365 | MP210K |
| PC1010 | L291 | L1200H | LS200H | LT366 | MP2104 |
| PC1040 | L291 | L21 | LS21 | LT367 | MP2104 |
| PC10150 | L291 | L21 | LS21 | LT368 | MP2104 |
| PC10150 | L291 | L21 | LS21 | LT369 | MP2104 |
| PC10150 | L291 | L21 | LS21 | LT370 | MP2104 |
| PC10150 | L291 | L21 | LS21 | LT371 | MP2104 |
| PC10150 | L291 | L21 | LS21 | LT372 | MP2104 |
| PC10150 | L291 | L21 | LS21 | LT373 | MP2104 |
| PC10150 | L291 | L21 | LS21 | LT374 | MP2104 |
| PC10150 | L291 | L21 | LS21 | LT375 | MP2104 |
| PC10150 | L291 | L21 | LS21 | LT376 | MP2104 |
| PC10150 | L291 | L21 | LS21 | LT377 | MP2104 |
| PC10150 | L291 | L21 | LS21 | LT378 | MP2104 |
| PC10150 | L291 | L21 | LS21 | LT379 | MP2104 |
| PC10150 | L291 | L21 | LS21 | LT380 | MP2104 |
| PC10150 | L291 | L21 | LS21 | LT381 | MP2104 |
| PC10150 | L291 | L21 | LS21 | LT382 | MP2104 |
| PC10150 | L291 | L21 | LS21 | LT383 | MP2104 |
| PC10150 | L291 | L21 | LS21 | LT384 | MP2104 |
| PC10150 | L291 | L21 | LS21 | LT385 | MP2104 |
| PC10150 | L291 | L21 | LS21 | LT386 | MP2104 |
| PC10150 | L291 | L21 | LS21 | LT387 | MP2104 |
| PC10150 | L291 | L21 | LS21 | LT388 | MP2104 |
| PC10150 | L291 | L21 | LS21 | LT389 | MP2104 |
| PC10150 | L291 | L21 | LS21 | LT390 | MP2104 |
| PC10150 | L291 | L21 | LS21 | LT391 | MP2104 |
| PC10150 | L291 | L21 | LS21 | LT392 | MP2104 |
| PC10150 | L291 | L21 | LS21 | LT393 | MP2104 |
| PC10150 | L291 | L21 | LS21 | LT394 | MP2104 |
| PC10150 | L291 | L21 | LS21 | LT395 | MP2104 |
| PC10150 | L291 | L21 | LS21 | LT396 | MP2104 |
| PC10150 | L291 | L21 | LS21 | LT397 | MP2104 |
| PC10150 | L291 | L21 | LS21 | LT398 | MP2104 |
| PC10150 | L291 | L21 | LS21 | LT399 | MP2104 |
| PC10150 | L291 | L21 | LS21 | LT400 | MP2104 |
| PC10150 | L291 | L21 | LS21 | LT401 | MP2104 |
| PC10150 | L291 | L21 | LS21 | LT402 | MP2104 |
| PC10150 | L291 | L21 | LS21 | LT403 | MP2104 |
| PC10150 | L291 | L21 | LS21 | LT404 | MP2104 |
| PC10150 | L291 | L21 | LS21 | LT405 | MP2104 |
| PC10150 | L291 | L21 | LS21 | LT406 | MP2104 |
| PC10150 | L291 | L21 | LS21 | LT407 | MP2104 |
| PC10150 | L291 | L21 | LS21 | LT408 | MP2104 |
| PC10150 | L291 | L21 | LS21 | LT409 | MP2104 |
| PC10150 | L291 | L21 | LS21 | LT410 | MP2104 |
| PC10150 | L291 | L21 | LS21 | LT411 | MP2104 |
| PC10150 | L291 | L21 | LS21 | LT412 | MP2104 |
| PC10150 | L291 | L21 | LS21 | LT413 | MP2104 |
| PC10150 | L291 | L21 | LS21 | LT414 | MP2104 |
| PC10150 | L291 | L21 | LS21 | LT415 | MP2104 |
| PC10150 | L291 | L21 | LS21 | LT416 | MP2104 |
| PC10150 | L291 | L21 | LS21 | LT417 | MP2104 |
| PC10150 | L291 | L21 | LS21 | LT418 | MP2104 |
| PC10150 | L291 | L21 | LS21 | LT419 | MP2104 |
| PC10150 | L291 | L21 | LS21 | LT420 | MP2104 |
| PC10150 | L291 | L21 | LS21 | LT421 | MP2104 |
| PC10150 | L291 | L21 | LS21 | LT422 | MP2104 |
| PC10150 | L291 | L21 | LS21 | LT423 | MP2104 |
| PC10150 | L291 | L21 | LS21 | LT424 | MP2104 |
| PC10150 | L291 | L21 | LS21 | LT425 | MP2104 |
| PC10150 | L291 | L21 | LS21 | LT426 | MP2104 |
| PC10150 | L291 | L21 | LS21 | LT427 | MP2104 |
| PC10150 | L291 | L21 | LS21 | LT428 | MP2104 |
| PC10150 | L291 | L21 | LS21 | LT429 | MP2104 |
| PC10150 | L291 | L21 | LS21 | LT430 | MP2104 |
| PC10150 | L291 | L21 | LS21 | LT431 | MP2104 |
| PC10150 | L291 | L21 | LS21 | LT432 | MP2104 |
| PC10150 | L291 | L21 | LS21 | LT433 | MP2104 |
| PC10150 | L291 | L21 | LS21 | LT434 | MP2104 |
| PC10150 | L291 | L21 | LS21 | LT435 | MP2104 |
| PC10150 | L291 | L21 | LS21 | LT436 | MP2104 |
| PC10150 | L291 | L21 | LS21 | LT437 | MP2104 |
| PC10150 | L291 | L21 | LS21 | LT438 | MP2104 |
| PC10150 | L291 | L21 | LS21 | LT439 | MP2104 |
| PC10150 | L291 | L21 | LS21 | LT440 | MP2104 |
| PC10150 | L291 | L21 | LS21 | LT441 | MP2104 |
| PC10150 | L291 | L21 | LS21 | LT442 | MP2104 |
| PC10150 | L291 | L21 | LS21 | LT443 | MP2104 |
| PC10150 | L291 | L21 | LS21 | LT444 | MP2104 |
| PC10150 | L291 | L21 | LS21 | LT445 | MP2104 |
| PC10150 | L291 | L21 | LS21 | LT446 | MP2104 |
| PC10150 | L291 | L21 | LS21 | LT447 | MP2104 |
| PC10150 | L291 | L21 | LS21 | LT448 | MP2104 |
| PC10150 | L291 | L21 | LS21 | LT449 | MP2104 |
| PC10150 | L291 | L21 | LS21 | LT450 | MP2104 |
| PC10150 | L291 | L21 | LS21 | LT451 | MP2104 |
| PC10150 | L291 | L21 | LS21 | LT452 | MP2104 |
| PC10150 | L291 | L21 | LS21 | LT453 | MP2104 |
| PC10150 | L291 | L21 | LS21 | LT454 | MP2104 |
| PC10150 | L291 | L21 | LS21 | LT455 | MP2104 |
| PC10150 | L291 | L21 | LS21 | LT456 | MP2104 |
| PC10150 | L291 | L21 | LS21 | LT457 | MP2104 |
| PC10150 | L291 | L21 | LS21 | LT458 | MP2104 |
| PC10150 | L291 | L21 | LS21 | LT459 | MP2104 |
| PC10150 | L291 | L21 | LS21 | LT460 | MP2104 |
| PC10150 | L291 | L21 | LS21 | LT461 | MP2104 |
| PC10150 | L291 | L21 | LS21 | LT462 | MP2104 |
| PC10150 | L291 | L21 | LS21 | LT463 | MP2104 |
| PC10150 | L291 | L21 | LS21 | LT464 | MP2104 |
| PC10150 | L291 | L21 | LS21 | LT465 | MP2104 |
| PC10150 | L291 | L21 | LS21 | LT466 | MP2104 |
| PC10150 | L291 | L21 | LS21 | LT467 | MP2104 |
| PC10150 | L291 | L21 | LS21 | LT468 | MP2104 |
| PC10150 | L291 | L21 | LS21 | LT469 | MP2104 |
| PC10150 | L291 | L21 | LS21 | LT470 | MP2104 |
| PC10150 | L291 | L21 | LS21 | LT471 | MP2104 |
| PC10150 | L291 | L21 | LS21 | LT472 | MP2104 |
| PC10150 | L291 | L21 | LS21 | LT473 | MP2104 |
| PC10150 | L291 | L21 | LS21 | LT474 | MP2104 |
| PC10150 | L291 | L21 | LS21 | LT475 | MP2104 |
| PC10150 | L291 | L21 | LS21 | LT476 | MP2104 |
| PC10150 | L291 | L21 | LS21 | LT477 | MP2104 |
| PC10150 | L291 | L21 | LS21 | LT478 | MP2104 |
| PC10150 | L291 | L21 | LS21 | LT479 | MP2104 |
| PC10150 | L291 | L21 | LS21 | LT480 | MP2104 |
| PC10150 | L291 | L21 | LS21 | LT481 | MP2104 |
| PC10150 | L291 | L21 | LS21 | LT482 | MP2104 |
| PC10150 | L291 | L21 | LS21 | LT483 | MP2104 |
| PC10150 | L291 | L21 | LS21 | LT484 | MP2104 |
| PC10150 | L291 | L21 | LS21 | LT485 | MP2104 |
| PC10150 | L291 | L21 | LS21 | LT486 | MP2104 |
| PC10150 | L291 | L21 | LS21 | LT487 | MP2104 |
| PC10150 | L291 | L21 | LS21 | LT488 | MP2104 |
| PC10150 | L291 | L21 | LS21 | LT489 | MP2104 |
| PC10150 | L291 | L21 | LS21 | LT490 | MP2104 |
| PC10150 | L291 | L21 | LS21 | LT491 | MP2104 |
| PC10150 | L291 | L21 | LS21 | LT492 | MP2104 |
| PC10150 | L291 | L21 | LS21 | LT493 | MP2104 |
| PC10150 | L291 | L21 | LS21 | LT494 | MP2104 |
| PC10150 | L291 | L21 | LS21 | LT495 | MP2104 |
| PC10150 | L291 | L21 | LS21 | LT496 | MP2104 |
| PC10150 | L291 | L21 | LS21 | LT497 | MP2104 |
| PC10150 | L291 | L21 | LS21 | LT498 | MP2104 |
| PC10150 | L291 | L21 | LS21 | LT499 | MP2104 |
| PC10150 | L291 | L21 | LS21 | LT500 | MP2104 |
| PC10150 | L291 | L21 | LS21 | LT501 | MP2104 |
| PC10150 | L291 | L21 | LS21 | LT502 | MP2104 |
| PC10150 | L291 | L21 | LS21 | LT503 | MP2104 |
| PC10150 | L291 | L21 | LS21 | LT504 | MP2104 |
| PC10150 | L291 | L21 | LS21 | LT505 | MP2104 |
| PC10150 | L291 | L21 | LS21 | LT506 | MP2104 |
| PC10150 | L291 | L21 | LS21 | LT507 | MP2104 |
| PC10150 | L291 | L21 | LS21 | LT508 | MP2104 |
| PC10150 | L291 | L21 | LS21 | LT509 | MP2104 |
| PC10150 | L291 | L21 | LS21 | LT510 | MP2104 |
| PC10150 | L291 | L21 | LS21 | LT511 | MP2104 |
| PC10150 | L291 | L21 | LS21 | LT512 | MP2104 |
| PC10150 | L291 | L21 | LS21 | LT513 | MP2104 |
| PC10150 | L291 | L21 | LS21 | LT514 | MP2104 |
| PC10150 | L291 | L21 | LS21 | LT515 | MP2104 |
| PC10150 | L291 | L21 | LS21 | LT516 | MP2104 |
| PC10150 | L291 | L21 | LS21 | LT517 | MP2104 |